

Bell Laboratories

RECORD

May/June 1969

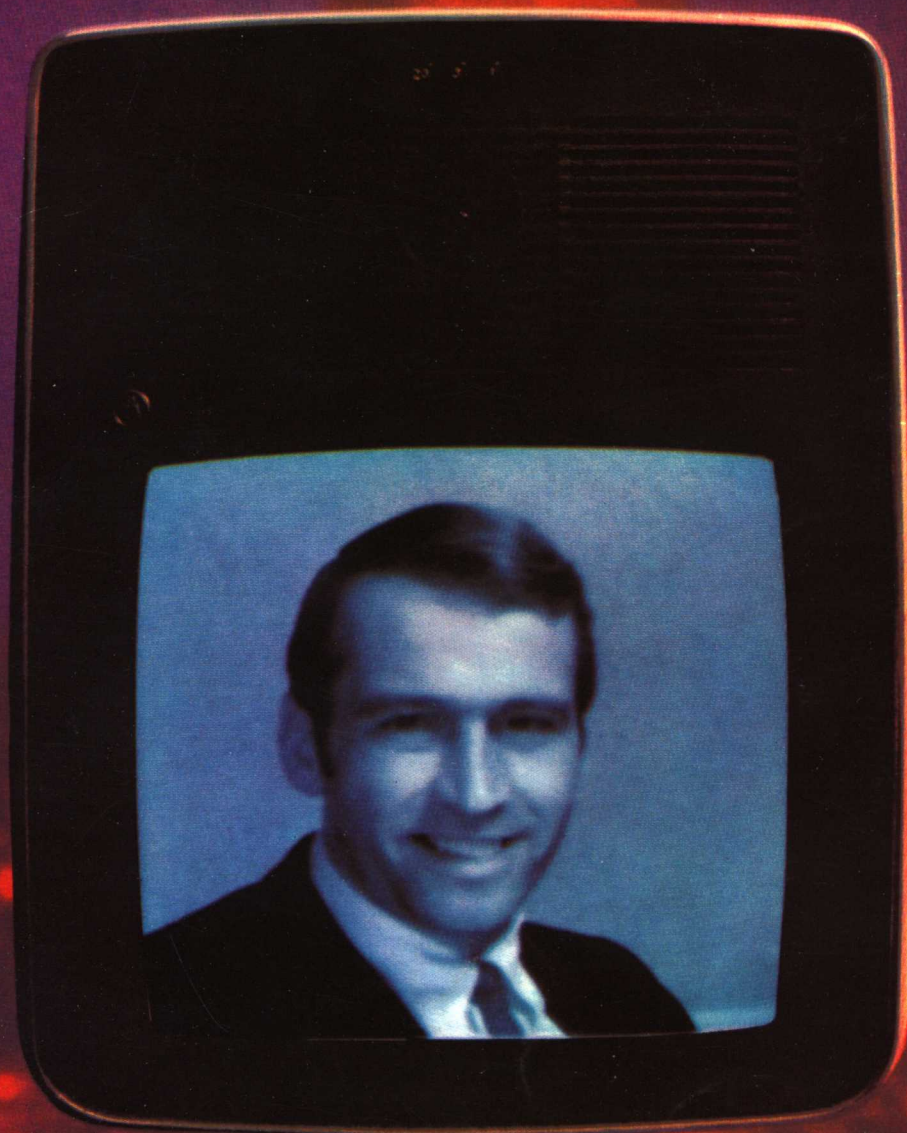

Bell Laboratories

RECORD

Volume 47 • Number 5 • May/June 1969

Editorial Board

C. A. Warren, *Chairman*

J. T. Bangert

W. D. Bulloch

J. S. Cook

A. E. Joel, Jr.

M. V. Mathews

C. R. Moster

F. M. Smits

A. E. Spencer

T. L. Triolo

Editorial Staff

G. E. Schindler, Jr., *Editor*

G. L. Bromleigh, Jr., *Managing Editor*

S. Fingerman, *Assistant Editor*

L. A. Howard, Jr., *Assistant Editor*

R. A. Meacham, Jr., *Assistant Editor*

Miss D. L. Neilson, *Editorial Assistant*

F. E. Piellusch, *Art Editor*

F. J. Schwetje, *Circulation*

THE BELL LABORATORIES RECORD is published monthly by Bell Telephone Laboratories, Incorporated, Mountain Avenue, Murray Hill, N. J. 07974, J. B. FISK, President; F. C. CHESTON, Secretary; and F. COWAN, Treasurer. Subscription: \$4.00 per year, plus \$1.00 foreign postage; single copies, \$.50. Checks should be made payable to Bell Laboratories RECORD and addressed to the Circulation Manager. Printed in U.S.A. © Bell Telephone Laboratories, Incorporated, 1969. Permission to reprint material from the RECORD may be obtained from the Editor.

THE PICTURE OF THE FUTURE

The Bell System is about to add PICTUREPHONE® service to the many services it now offers customers. A major trial of a Picturephone system is presently under way, and commercial service is scheduled for mid 1970. Because Picturephone service is a large undertaking that will have a profound effect on communications, the RECORD is pleased to be able to present this special issue describing the new system for our readers.

Special issues have become an important part of the RECORD's continuing story of science and technology at Bell Labs. The first one, in June 1958, dealt with the transistor and marked the tenth anniversary of its invention at Bell Labs. Since then there have been special issues on the TELSTAR® project, No. 1 Ess, and integrated electronics. In addition, there have been single-topic issues devoted to the N-3 and L-4 carrier transmission systems. We hope to continue to present such special issues from time to time as a way of highlighting subjects of special importance.

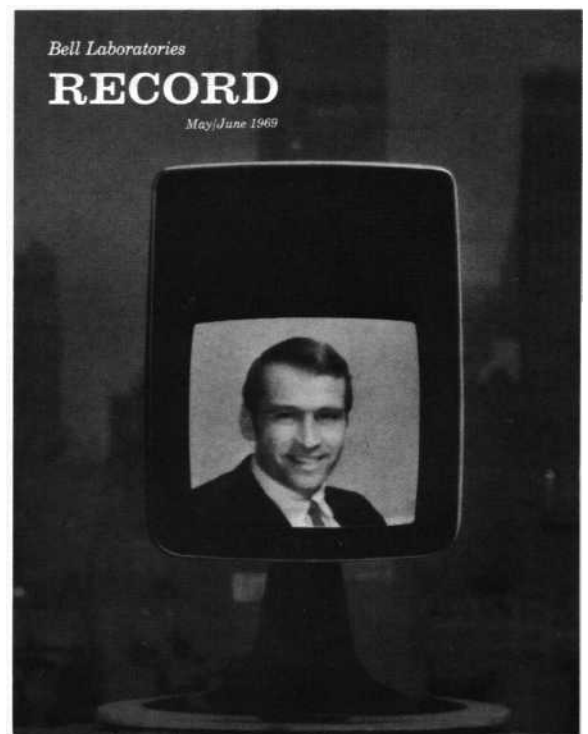

Contents

PAGE		
134	PICTUREPHONE Service-A New Way of Communicating	
	<i>An introduction by Julius P. Molnar, Executive Vice President, Bell Telephone Laboratories.</i>	
136	PICTUREPHONE	<i>Irwin Dorros</i>
	<i>A broad view of the PICTUREPHONE system sets the stage for the more detailed discussions that follow.</i>	
142	Getting the Picture	<i>C. G. Davis</i>
	<i>The acceptance of PICTUREPHONE service depends largely on the equipment that people will see and use-the PICTUREPHONE set itself.</i>	
148	Video Service for Business	<i>J. R. Harris and R. D. Williams</i>
	<i>A look at how PICTUREPHONE service will be added to existing business telephone systems.</i>	
154	Choosing the Route	<i>F. A. Korn and A. E. Ritchie</i>
	<i>A proven Bell System performer, No. 5 crossbar, will be the nucleus for switching a brand-new communications service.</i>	
160	The Evolution of PICTUREPHONE Service	
	<i>Photos highlighting some important dates and events that have led up to the system described in this issue.</i>	
162	Transmission Across Town or Across the Country	<i>D. W. Nast and I. Welber</i>
	<i>Digital transmission is the key to plans for transmitting high-quality PICTUREPHONE signals over almost unlimited distances.</i>	
169	Connecting the Customer	<i>F. T. Andrews, Jr., and H. Z. Hardaway</i>
	<i>The continually-evolving customer loop plant is adding a new capability to its communications repertoire-video transmission.</i>	
174	Devices-The Hardware of Progress	<i>S. O. Ekstrand</i>
	<i>PICTUREPHONE service would not be possible without the electronic devices that modern technology has produced.</i>	
181	Maintenance-Keeping the System in Trim	<i>A. E. Spencer</i>
	<i>A description of some of the equipment and procedures that will be used to maintain the PICTUREPHONE system.</i>	
186	Tomorrow	
	<i>Some of the things Bell Labs is doing now to make the PICTUREPHONE system an even better, more versatile instrument for human communication.</i>	
188	The Authors	

Picturephone Service- A New Way of Communicating

An Introduction by Julius P. Molnar, Executive Vice President, Bell Telephone Laboratories

Rarely does an individual or an organization have an opportunity to create something of broad utility that will enrich the daily lives of everybody. Alexander Graham Bell with his invention of the telephone in 1876, and the various people who subsequently developed it for general use, perceived such an opportunity and exploited it for the great benefit of society. Today there stands before us an opportunity of equal magnitude- PICTUREPHONE® service.

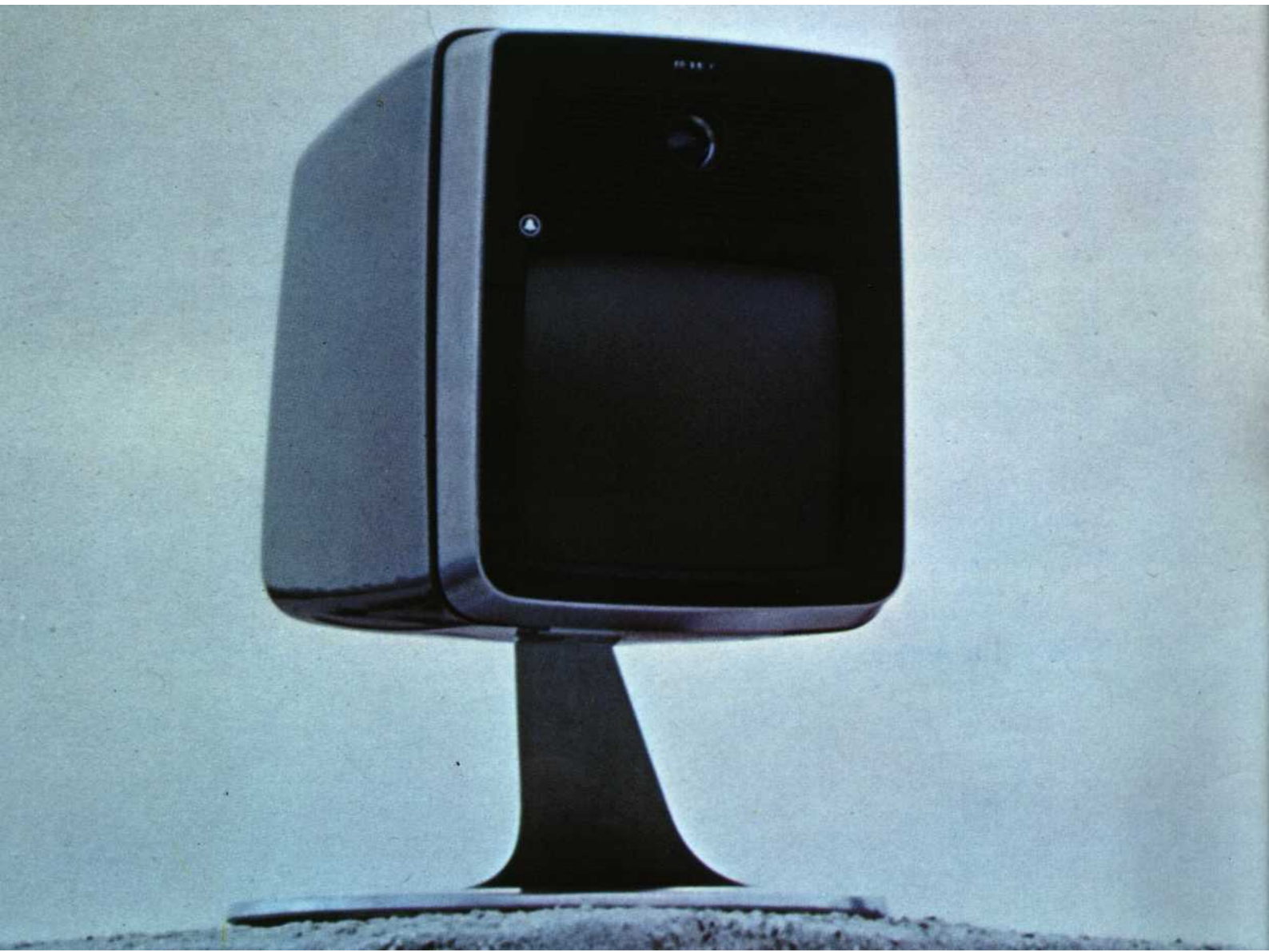

FIFTY YEARS AGO people communicated over distances mainly by letters and telegrams, and used streetcars, railroads, and ships for travel to see each other. Gradually telephone usage increased until it is today the most common means of communication, and the automobile and jet airplane now provide most of the transportation we use to get together for face-to-face conversation. I predict that before the turn of the century Picturephone will similarly displace today's means of communication, and in addition will make many of today's trips unnecessary.

The urge to travel and see the world with one's own eyes will probably be enhanced, not lessened, by the availability of instant, personal picture communications; but the need for many ordinary trips for shopping, for conducting normal business, and for some social purposes should be greatly reduced. As a result, there will be less need for dense population centers. We can even hope to see an end to the continuing increase in city traffic and traffic jams.

Picturephone is therefore much more than just another means of communication. It may in fact help solve many social problems, particularly those pertaining to life in the big city. Bringing Picturephone into general use I see as one of the most exciting opportunities for the wise use of modern technology.

Most people when first confronted with Picturephone seem to imagine that they will use it mainly to display objects or written matter, or they are very much concerned with how they will appear on the screen of the called party. These reactions are only natural, but they also indicate how difficult it is to predict the way people will respond to something new and different.

Those of us who have had the good fortune to use Picturephone regularly in our daily communications find that although it is useful for displaying objects or written matter, its chief value is the *face-to-face* mode of communication it makes possible. Once the novelty wears off and one can use Picturephone with-

out being self-conscious, he senses in his conversation an enhanced feeling of proximity and intimacy with the other party. The unconscious response that party makes to a remark by breaking into a smile, or by dropping his jaw, or by not responding at all, adds a definite though indescribable "extra" to the communication process. Regular users of Picturephone over the network between BTL and AT&T's headquarters building have agreed that conversations over Picturephone convey much important information over and above that carried by the voice alone. Clearly, "the next best thing to being there" is going to be a Picturephone call.

Real person-to-person conversation is still man's most complete and satisfying way of communicating. Letters and other written forms of expression have their values, but they suffer from two disadvantages. They are essentially one-way communications, and with written words it is difficult to convey meanings beyond their strict lexical definitions. The telephone overcomes one of these disadvantages because it permits a two-way, give-and-take interchange of information and ideas. It partially overcomes the second disadvantage also, because in addition to the literal meanings of words, one can—with voice tone, volume and inflection—convey many of the additional elements of a complete communication.

For the final, visual elements of two-way communication, we have had to rely on visits, meetings, and conferences. Even here there is a disadvantage, however. Such communication is at its best only when the participants are within about ten feet of each other. Beyond this distance, face-to-face communication quickly becomes unsatisfactory. Just as the telegraph overcame this distance barrier for written words, and the telephone for spoken words, so Picturephone service will bring people face-to-face across our continent and eventually over oceans.

(For concluding remarks and a look into the future of Picturephone service, see p. 186.)

BASIC LOCAL ARRANGEMENT

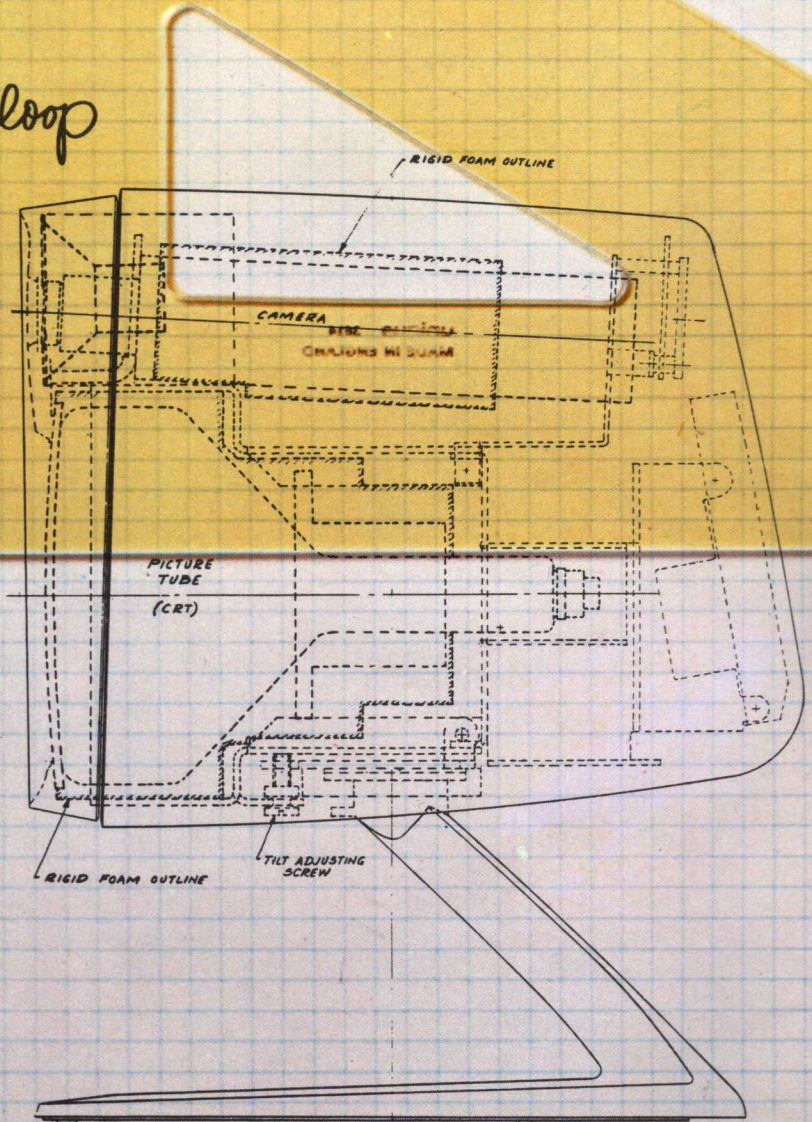
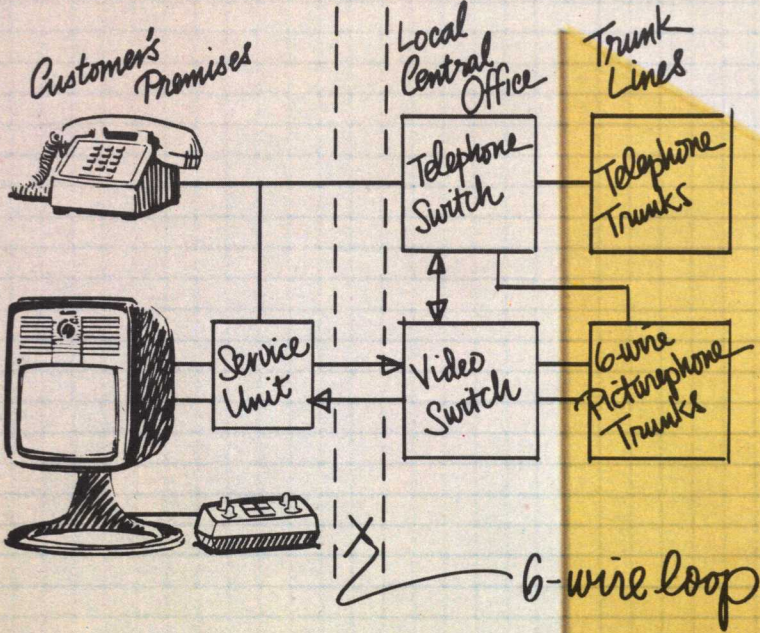

Irwin Dorros

Picturephone[®]

Picturephone service, a product of Bell System research and development, adds a new dimension to telephone communication — that of sight. Here is a discussion of the system that has evolved to make the telephone conform more perfectly to the communication needs of people.

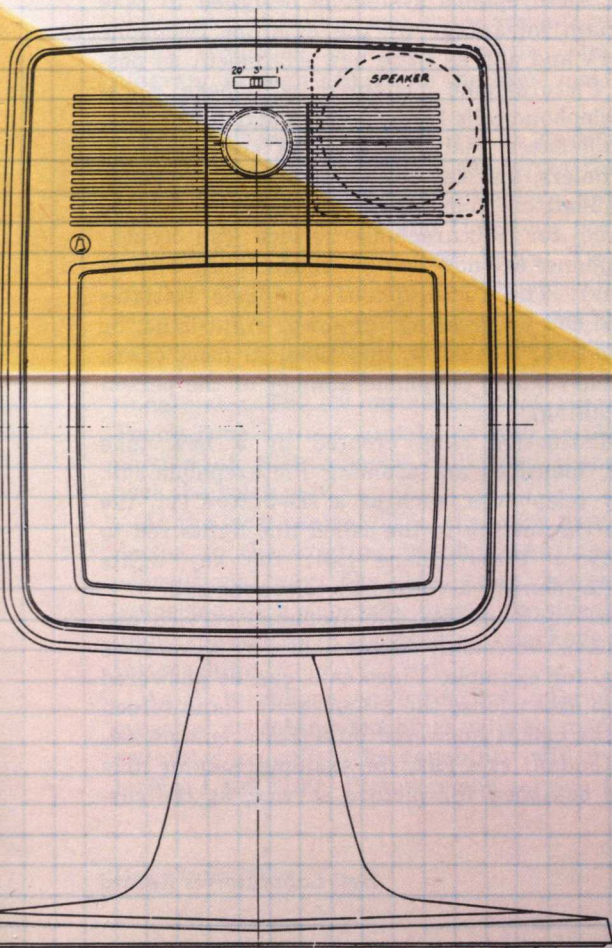

THE TELEPHONE brought a new dimension to human communications. Where previously men had been able to send written messages over wires as electrical signals, the telephone made it possible for the human voice to span the miles. Now, almost a hundred years later, the telephone is commonplace and another dimension is being added—that of sight. And just as the telephone has revolutionized human habits of communicating and made a major contribution to the quality of modern life, many of us at Bell Labs believe that PICTUREPHONE® service, the service that lets people see as well as hear each other, offers potential benefits to mankind of the same magnitude. It is a tribute to the flexibility and versatility of the existing telephone network that Picturephone service, now being readied for introduction as a regular Bell System offering, can be added as an integral part of telephone service.

What is Picturephone service like? Most important, of course, the user sees the person with whom he is talking. People today are so accustomed to using the telephone and to its usefulness as an instrument of communication, that they sometimes overlook the importance of vision in communication. But think, do you telephone the person in the next office or go to see him? Most people sense a more complete and satisfying exchange when they can both see and talk to each other. Thus, the advantage of more complete communication with Picturephone service is readily apparent.

Picturephone service is useful in other ways too. Graphic material, such as drawings, photographs, and physical objects, can be viewed with the Picturephone set. The equipment can also be used to communicate with a computer. The customer "talks" to the computer via TOUCH-TONE® dialing buttons, and the computer's responses are displayed on the picture tube (see *Picturephone Sets Put a Computer on Executive Desks*, RECORD, June 1968).

When Picturephone service becomes available commercially (in the early 1970's), it will probably be accepted most readily by businesses—particularly by large corporations. The executives of a corporation with offices in different locations form a natural "community" with a need for the utmost in communication facilities. Trials already conducted and now in progress have demonstrated the usefulness of Picturephone service in the corporate environment (see *The Evolution of Picturephone Service*, RECORD, October 1968). As Picturephone service becomes widely available and a public awareness of it develops, it will spread gradually into the residential market.

The equipment at the Picturephone customer's location consists of four parts: a 12-button Touch-Tone telephone; a display unit, with picture tube, camera tube, and a loudspeaker built in; a control unit, which contains a microphone; and a service unit containing power supply, logic circuits, and transmission equalizing circuits, which is installed out of sight.

Picture standards have been chosen for the best possible picture, subject to the limits imposed by cost and transmission capabilities (see the table on page 139). The picture signal is composed of about 250 active lines, displayed 30 times per second on a 5.5-inch by 5-inch screen. Resolution is the same in the vertical and horizontal directions. The quality of the picture equals that of a typical television set in the home. Transmitting the picture signal requires a 1-MHz bandwidth.

Normally, a person using the Picturephone set will be about 36 inches away from the screen. The field of view at that distance is adjustable from 17.5-by-16 inches to 28.5-by-26 inches. This range of sizes is designed to give the user freedom to move from side to side during his conversation, and to permit one or two other persons to be "on camera" at the same time. The camera iris automatically adjusts the lens for changes in room lighting.

The Picturephone system is designed to take maximum advantage of the existing telephone network and add as little new equipment as possible. Picturephone customers will make voice-only telephone calls from their regular telephones, with all extra features, such as speakerphone, card dialers, and key telephone options, in place.

A 12-button Touch-Tone telephone set will be required for Picturephone service (all Touch-Tone phones are now being manufactured with 12 buttons). The Picturephone customer initiates a video call by pressing the lower right-hand, or 12th button, labeled #, and then, in most cases, dials the regular telephone number of the person he is calling.

A distinctive ring, created by a new tone ringer, identifies an incoming Picturephone call. In key telephones, such as a six-button set, the key corresponding to the called line lights red to identify a Picturephone call; the key lights white to identify a voice-only telephone call.

Lines equipped for Picturephone service can also have voice-only extensions—a secretary's pickup, for example. Video calls can be answered on such extensions; the caller sees a blank screen until the call is answered on a Picturephone set. An attendant at a PBX, for example, may or may not be equipped for picture service, as the cus-

tomer wishes. In addition, at the customer's option a fixed image, such as a company trademark, can be transmitted to the caller while the attendant handles the call.

Communication services available to the business community today range from simple direct lines to PBX and centrex arrangements for business customers. Individual service features include dial intercommunication, attendant service, and, in the case of centrex, direct inward dialing to telephones and identified outward dialing, as well as a variety of sophisticated services tailored to meet specific needs.

Picturephone service will be a valuable addition to the telephone services already available to business. To assure continuation of these services, new Picturephone key telephone units offering pickup, hold, and intercom service will be furnished. Customers served by the 701 and 757 PBX's, the No. 101 ESS, and the No. 5 crossbar centrex-CO (switched in the central office) systems will be able to add Picturephone service and retain all of their major PBX and centrex features. Picturephone service with the No. 1 ESS centrex-CO system and other new PBX systems will be introduced later.

Thus far, our discussion has related primarily to Picturephone service as it will affect the user. What about the rest of the system? Here too the philosophy of taking maximum advantage of existing telephone facilities prevails. The upper diagram on page 140 shows the basic local equipment arrangement.

Picturephone service requires no modifications to existing two-wire loops (the wires that connect a customer's telephone to the local switching office) ; voice-only calls and the voice portion of Picturephone calls use these wires. Two more pairs of wires in standard telephone cables are assigned for the picture signals, one pair for transmission in each direction. Equalizers are inserted at about one-mile intervals along the additional pairs. The ON-OFF switch-hook signals and Touch-Tone dialing signals, as well as the voice portion of Picturephone calls, are transmitted over the voice pair.

At the local central office, the voice pair is connected to the existing telephone switch in the conventional way. The video pairs, however, are connected to a separate four-wire video switch under the control of the existing telephone switching machine.

As Picturephone service is first offered, No. 5 crossbar switching machines will be modified to switch video calls; the capability will be added to No. 1 ESS later. Picturephone service for cus-

PICTURE STANDARDS	
Bandwidth	1 MHz
Active Lines Per Frame	≈ 250
Frames Per Second	30
Fields Per Frame	2 Interlaced
Screen Size	5-½" x 5"
Viewing Distance	36"
Field of View (Normal)	17-½" x 16"
Field of View (Expanded)	28-½" x 26"

tomers served from step-by-step, panel, or No. 1 crossbar offices will be routed to a nearby No. 5 crossbar or, later, a No. 1 ESS office.

Whenever a customer dials a call, the common control equipment in the switching machine recognizes the digits and causes a talking path to be established. For voice-only calls, the existing two-wire telephone switch will make the connection. When the special prefix, #, is dialed, indicating a Picturephone call, the talking path is established by the two-wire telephone switch, and a path is established simultaneously by the four-wire video switch to the trunk side of the switching machine. There, the audio and video paths form a composite six-wire appearance. For intra-office calls, the six-wire Picturephone signal returns through the switches to another line. For calls to a distant central office, however, the path is established over a six-wire Picturephone trunk. The audio portion of the six-wire trunk is never used for voice-only telephone traffic.

The Picturephone signal discussed thus far is a line-by-line electrical representation of the scanned shades of gray, in the picture material. Short synchronizing pulses, between scan lines and fields, tell the receivers how to line up the parts of images. This kind of signal is called "analog." Between central offices, up to about six miles apart, the picture signal is transmitted over the

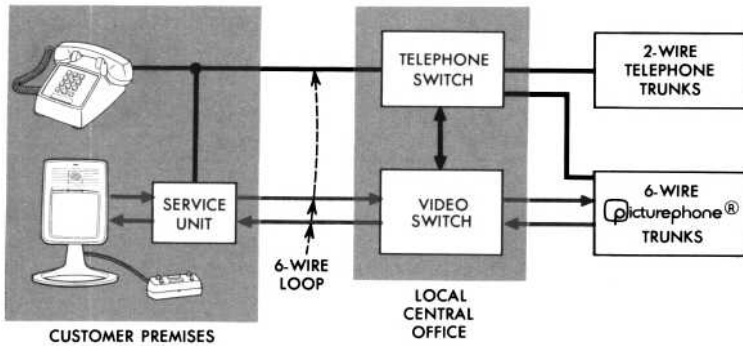

The customer's Picturephone set is connected to the local central office over a six-wire loop. As in today's telephone service, one pair of wires carries the voice signal. Two other pairs with equalizers are used for the two directions of video transmission. The audio pair is switched in the central office in the conventional way, while the video portion is switched by a newly designed four-wire video switch controlled by the switching machine. The entire Picturephone signal is switched to other central offices over a special six-wire trunk; voice-only calls continue to be switched over conventional two-wire trunks.

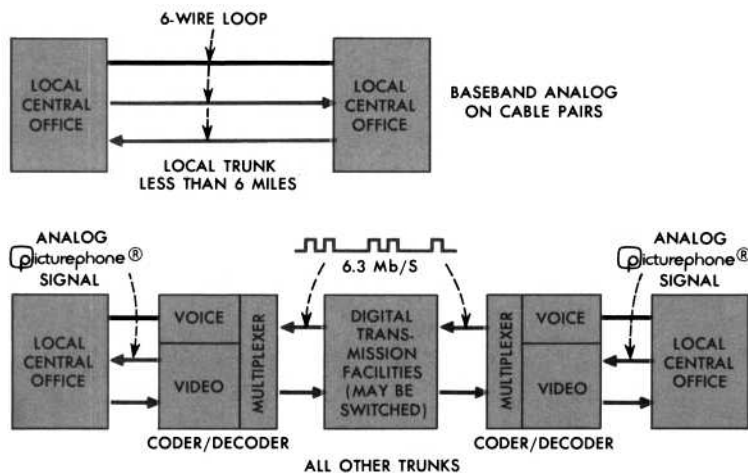

The Picturephone signal is transmitted between nearby central offices (less than six miles) in analog form (top). For transmission beyond six miles, the picture signal and the audio and signaling information are digitally encoded into a composite 6.3-Mb/s signal and decoded again at the distant office.

Picturephone trunk in analog form. The Picturephone trunk in this case consists of three separate wire pairs in exchange cables, with equalizers placed at about one-mile spacing in the two video pairs, as in loops.

For transmission beyond six miles, the picture, voice, and interoffice signal information is digitally encoded into a composite pulse stream of 6.3 megabits per second (Mb/s). This is called a "digital"

signal. Once encoded, a signal usually is not decoded until it is within six miles of the distant local central office. Limitation to a single encoding in a connection is required to prevent an accumulation of the picture degradation that occurs each time the signal is coded and decoded. While some impairment is caused by the single coding and decoding, digital transmission is highly desirable because virtually no further impairment occurs during the transmission of the digital pulse streams.

Picturephone signals remain in digital form for switching in toll offices. No. 5 crossbar switching offices will be the first to perform the toll switching function. Later electronic toll centers now being planned will switch Picturephone calls.

The application of analog and digital transmission is shown below left. The T-2 digital carrier system, expected to be introduced in the near future, transmits at 6.3 Mb/s and is, in fact, the reason for selecting this particular signal encoding rate for Picturephone signals. The T-2 system operates over wire pairs for distances up to several hundred miles.

Digital transmission systems now being developed will ultimately take over the long-haul transmission of Picturephone signals. Until then, two existing facilities will be used: the TD-2 microwave radio relay system and the L-4 carrier system. In TD-2, a 20-Mb/s pulse stream, carrying three coded Picturephone signals, is transmitted on a single radio channel. In the L-4 system, a 13-Mb/s pulse stream, carrying two coded Picturephone signals, is transmitted in place of one of the six mastergroups on a coaxial tube. No additional transmission facilities, other than the designs now existing or contemplated for regular telephone service, will be necessary to transmit Picturephone signals. A single transmission network will transmit all services.

The picture that is finally viewed at a Picturephone receiver contains impairments introduced by each part of the built-up connection. Just as in today's telephone network, the end-to-end impairments are controlled by holding each part of the connection within specified limits. Based on analytical calculations and subjective tests, each of these has been assigned a numerical end-to-end maximum value with a specified limit allocated to stations, loops, trunks, etc. Dealing with these impairments requires techniques that are, in many cases, different from those used for audio transmission systems. The necessary new techniques are being developed.

The switched network arrangements for Picturephone service will be useful for services in

addition to Picturephone calling. Equipment will be developed that, to the network, looks like a Picturephone set, but is actually a data set. A customer will be able to dial the data set, using a regular Picturephone number, and reach a computer. The Touch-Tone dial will then be the means of communicating with the computer to retrieve data or interact in a computation. (One kind of computer response is shown in the upper photograph on this page.)

The network will also be equipped to handle machine-to-machine data traffic at a rate of about one Mb/s, much as DATA-PHONE® service handles voice-band data. Such service will require an appropriate data set at each end of a connection.

To verify the practicality of the Picturephone system plan, to make refinements in it, and to test customer acceptance of the features, a product trial was begun in February of this year and is still in progress. A total of 41 sets have been placed in offices of the Westinghouse Electric Corporation in Pittsburgh and New York with toll links between cities. Each set can be dialed from any other set, and computer access facilities are included in this trial. Acceptance by the users has been enthusiastic.

Many readers will be led to speculate about possibilities for future improvements. Among the items currently receiving attention are higher resolution for transmitting detailed documents, color, capability for making conferences calls, and reducing the transmission band by taking advantage of inherent redundancy in video images.

Satisfactory transmission of a stationary image, such as a drawing resting on a table, does not require 30 frames per second. In theory an image may be slowly scanned a few times per second with many lines, resulting in higher-resolution transmission within the same 1-MHz channel. Optional equipment arrangements to achieve this are now being investigated.

A sizable fundamental research effort is now in progress to gain enough understanding to propose a compatible color system for future phases of the service.

For Picturephone conference calling, an experiment is now in progress in which a voice-actuated switch causes the picture of the person talking to appear on the screens of all other conferees. Finally, a number of signal-processing approaches which may reduce the 6.3-Mb/s rate of transmission are in the research stages.

A practical beginning has been made. Development of Picturephone service to its present stage brings the goal of better, more natural, and more nearly complete communications nearer to reality.

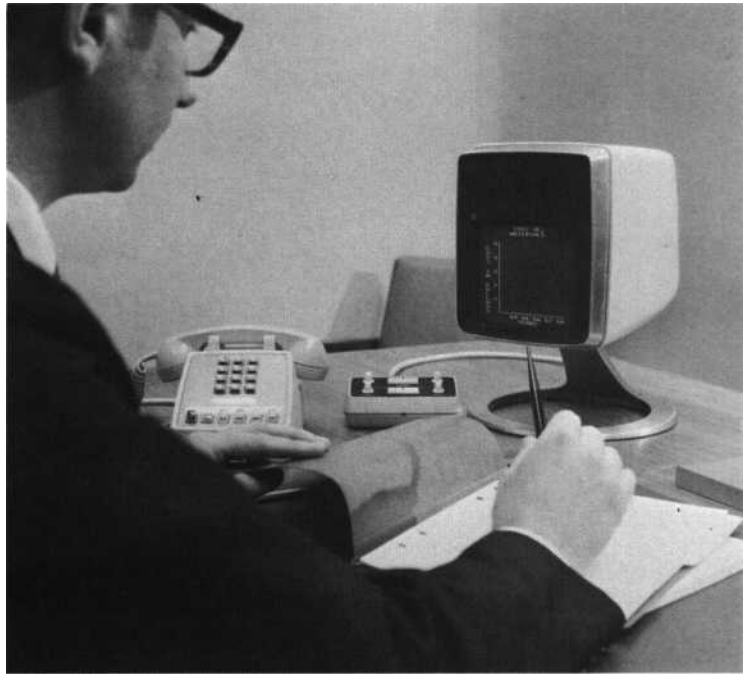

Besides the "see-as-you-talk" capability of the Picturephone set, man can communicate with a computer as well. A data set, which appears to the switched network as a regular Picturephone set, permits the set to be connected to a commercial computer. In this case, the Touch-Tone dial is used to communicate with the computer and the information retrieved or the results of a computation can be displayed on the Picturephone screen. The variety of characters available to display information on the Picturephone screen is shown in the bottom photo.



The greatest technical accomplishment in the world may go unused if it is not designed with people in mind. Thus, the parts of the Picturephone system that people will use directly have been designed to be attractive, easy to operate, reliable, and versatile.

Getting the Picture

C. G. Davis

PEOPLE'S REACTIONS to PICTUREPHONE® service will be based largely on the unit that displays the picture, along with accompanying controls and other items in the customer's home or office. Is the equipment attractive? Functional? Reliable? Is it easy to use? Is the picture good? Coming up with the right answers to these and similar questions has been a major concern at Bell Labs as the Picturephone system has evolved.

The "right answers" means, first of all, that the picture itself must be clear and sharp and must stay that way without a lot of tuning adjustments. The equipment must be easy to operate. The camera must adapt readily to a variety of picture subjects, backgrounds, and lighting conditions. At the same time, the set must be versatile enough to meet diverse needs such as showing sketches or objects, changing the field of view, or allowing the person using it to turn off the camera if he doesn't want to be seen. The user should be able to select any of these modes easily and conveniently, with little need for thought or chance of error. Finally, the set, like all Bell System equipment, must be designed for a long life of trouble-free service under the hazards of everyday use.

These objectives, and the knowledge gained from study and experimentation over the past 10 years (see *The Evolution of Picturephone Service*, RECORD, October 1968), have helped shape technical possibilities and customer preferences

into a successful Picturephone system. In 1965, a significant milestone in the evolution of Picturephone service was the beginning of product trials, using what was called the "Mod I" Picturephone set. The results of these trials were then used to develop the latest and completely new Picturephone set, known as the Mod II.

The Mod II set consists of a picture display unit (containing the camera, picture tube, and loudspeaker), a control unit (containing the control buttons and knobs and a microphone), a 12-button TOUCH-TONE® telephone, and a service unit (containing the power supply, logic circuits, and transmission equalizing circuits). The first three units are color-coordinated and intended to fit in as harmoniously as possible with any decor, since they will almost always be in plain sight. The service unit is intended to be installed out of sight and can be up to 85 feet away from the other three.

The display unit is mounted on a sculptured ring stand and can be turned almost all the way around (340 degrees) on the stand. Since the ring stand has a "non-skid" base, the unit is not easily pushed or pulled off the surface on which it rests. However, when the unit



is tilted close to the point of tipping over, the non-skid material, which covers only part of the base, lifts away from the surface and the unit slides instead of falling on its side. All of the video circuits, the camera and picture tubes, and the speaker are in the display unit. The area around the face of the picture tube has a mat black finish, which is ringed by a band of chrome that serves as a transition to any of the many available shell colors.

The picture tube face, which is 5 by 5.5 inches, displays a picture constructed in the same way as that on a home TV set. That is, it displays 30 frames a second using odd-even line interlace to give 60 fields a second, thereby yielding an acceptable "flicker" rate. A complete frame consists of about 250 visible interlaced lines, and horizontal and vertical resolution are essentially equal.

A near-perfect interlaced picture is provided in the camera by an integrated digital synchronizing generator, which is probably the most unusual circuit in the station set (see *Devices-The Hardware of Progress*, in this issue). The

The customer service unit contains the low-voltage power supply, the control circuits, and the station set equalizer, where required. The unit is usually not in view at an office or home, and can be placed up to 85 feet away from the other units.

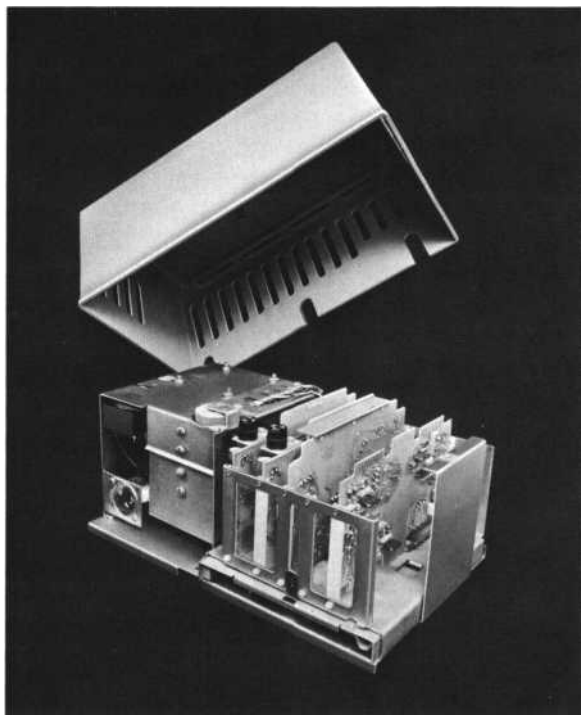

synchronizing generator promises to yield significant cost savings in the production version of the Picturephone set.

Beyond the quality of the picture itself, other factors played an important part in the design of the display unit. For example, the camera is placed above the picture tube to make the eye contact angle as small as possible. This is significant because, while the camera is looking at the subject, the subject is looking at the picture tube. The apparent "looking away" is annoying to the viewer unless the angle is small. The least annoyance occurs when the subject appears to be looking slightly down, which is frequently the case in normal conversation. Locating the camera just above the picture tube creates this effect.

The best position for the camera has proved to be about 12 inches above the desk top so that its field of view is essentially straight ahead. Here the camera gets the most natural-looking, least distorted view of the subject, keeping him on camera while allowing some movement, and (hopefully) not picking up too many ceiling lights.

The lens in the camera has an aperture of $f/2.8$, with a viewing angle of about 53 degrees. It is normally focused for a distance of about 3 feet from the set. This distance can easily be changed, however, by moving the button above the lens to the left or "20" position, changing the focal distance to a field centered about 20 feet from the set.

An automatic iris adjusts the lens opening for ambient lighting conditions. The iris is of a unique friction-free design, and is controlled by peak averaging of the video signal. Omitted from these measurements, however, are the upper and lower quarters of the picture, where ceiling lights and white shirts could unduly influence the camera setting. When the iris has opened completely (at a scene brightness of about 12 foot-lamberts) an automatic gain control circuit in the camera amplifier takes over control of the signal level, although with increasing noise as the light level decreases. In good light, with a small opening of the iris, the camera has an increased depth of field. This effect is exactly the same as with an ordinary photographic camera, where a large "f" number allows both near and far objects to be in sharp focus.

In addition to the camera, the display unit also contains a loudspeaker. Since the voice coming through the speaker is normally that of the person in the picture, it is appropriate that the loudspeaker be located as close as possible to the picture. However, since the loudness of the voice is best controlled by the listener, the "VOLUME"

control knob is located on the separate control unit, which is normally at his fingertips.

The "ON" button, of course, turns the set on. But, during a conversation, if the viewer desires to mute his microphone, he again presses and holds the "ON" button. This allows him to talk to someone else in the room without being heard by the person at the other end of the line. To resume conversation over his Picturephone set, he simply releases the button.

Although the user will normally stay reasonably centered on camera without giving the matter any attention, he can check his position by pressing the "MONITOR" button on the control unit and viewing his own picture. Pressing the "MONITOR" button a second time returns the picture of the person at the other end of the line. If at any time the user does not want to be seen (a frequent concern of housewives), he (or she) can press the "DISABLE" button and a distinctive bar pattern will be substituted for the picture. As with the "MONITOR" button, pressing the "DISABLE" button a second time returns the picture.

"SIZE" and "HEIGHT" controls are real contributions to the versatility of the Picturephone set. They permit the user to "zoom" his camera, changing the field of view by more than 2 to 1 in area, and to adjust the effective height at which the camera is pointed. Both functions are controlled from the control unit, without involving any mechanical movement of lenses or camera assembly. The adjustments are made possible by the silicon target in the camera, because the silicon target doesn't "burn-in" a memory of the area scanned by the electron beam.

The image on the camera target is always that of a field 26 inches high by 28.6 inches wide about 3 feet in front of the set. When the size control is turned to its upper extreme, the entire target is scanned, giving a "wide-angle" field of view. When the size control is set at the lower extreme, only a portion of the target, corresponding to a field 16 inches by 17.6 inches at the 3-foot distance, is scanned. While this narrow-angle field is considered the normal position, resolution may be traded for greater field of view either to allow the user to move around more in front of the camera or to accommodate more than one person on camera (see A "Solid-State"

Using the SIZE and HEIGHT controls on the control unit, a person making a Picturephone call can adjust his (or her) own image without moving the display unit itself. The HEIGHT control moves the image up (top, at right) or down. The SIZE control moves the image away, in effect, or brings it closer, electronically. A camera iris automatically adjusts the lens aperture to compensate for any differences in light intensity.



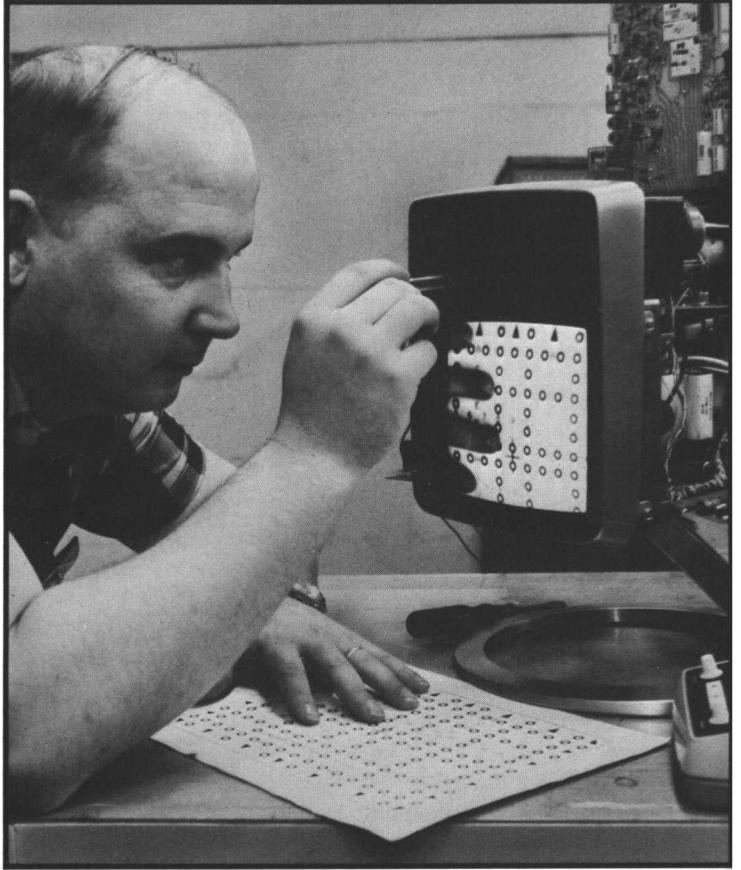

Electron Tube for the Picturephone Set, REC-ORD, June 1967).

For any setting less than the widest angle, the user can, by adjusting the HEIGHT control, move the reduced raster to scan the top or bottom portions of the image. Although a mechanical tilt adjustment allows an installer to compensate for desk and chair heights, the user can later adjust the set for his own height by using the electronic height control.

While Picturephone service is intended primarily for face-to-face conversation, visual communication sometimes entails showing drawings, documents, or other physical objects. This can be awkward if the customer has to hold things up in front of the camera. Therefore, the set is designed so the user can point the camera down at the surface on which the set rests and still keep the picture tube in view. This is done with a mirror swivel-mounted in the display unit. It can be brought in front of the camera by moving the button above the camera lens to the "1" position. The field of view of the camera when the mirror is out is 5 inches by 5.5 inches, with the top of the field at the edge of the ring stand. Moving the mirror into position also shortens the focal distance of the lens to one foot, reverses the camera sweep to correct for the mirror image, and locks the camera in the narrow-angle mode. The resolution at this distance is adequate for simple sketches, photographs, and the like. Typed text is of marginal legibility, and the 5x5.5-inch field does not, of course, encompass an 8.5x11-inch typed page.

Inside the plastic shell of the display unit, a heat shield at the front of the camera and a copper heat sink keep the camera from getting too hot. Both the shield and the heat sink are necessary since the right place for the camera from a human-factors standpoint turns out to be the worst possible place from a heat standpoint. An aluminum heat sink at the rear of the display unit holds the power transistors for the sweep drives and the power supply for the cathode-ray

heater. Top and bottom vents at the rear of the shell provide chimney action for cooling this heat sink.

The high-voltage power supply is encapsulated directly in front of the aluminum heat sink. When the shell is removed, an interlock at the rear of the unit disables the high-voltage power supply. A strategically placed shield on the receiver reduces interference between the transmit and receive sections of the set. Controlling this interference between the high-voltage drive pulses for the cathode-ray tube and the low signal level at the camera output was the most difficult problem in assembling the circuits into a unit.

The low-voltage power supply and the control circuits (as well as an equalizer where required) are contained in the service unit, which uses commercial power. Since no standby battery is provided, failure of commercial power removes the video portion of Picturephone service (but does not affect the voice portion).

The Picturephone equipment that the Bell System's customers will use has been designed with close attention to human factors, to simulate as closely as possible the free and natural communication of face-to-face conversation. A modest graphics capability is included, and adjustments that people will have to make are limited to those they are most likely to want. The Mod II set is expected to serve well as Picturephone service becomes commercially available over the next few years.



Picturephone display units being assembled and tested at Western Electric's Indianapolis plant. Among the many operations: mounting the picture tube and frame assembly on the ring stand (top left), checking circuit boards visually (top right), placing them in the display unit (bottom left), and finally, testing for picture alignment.

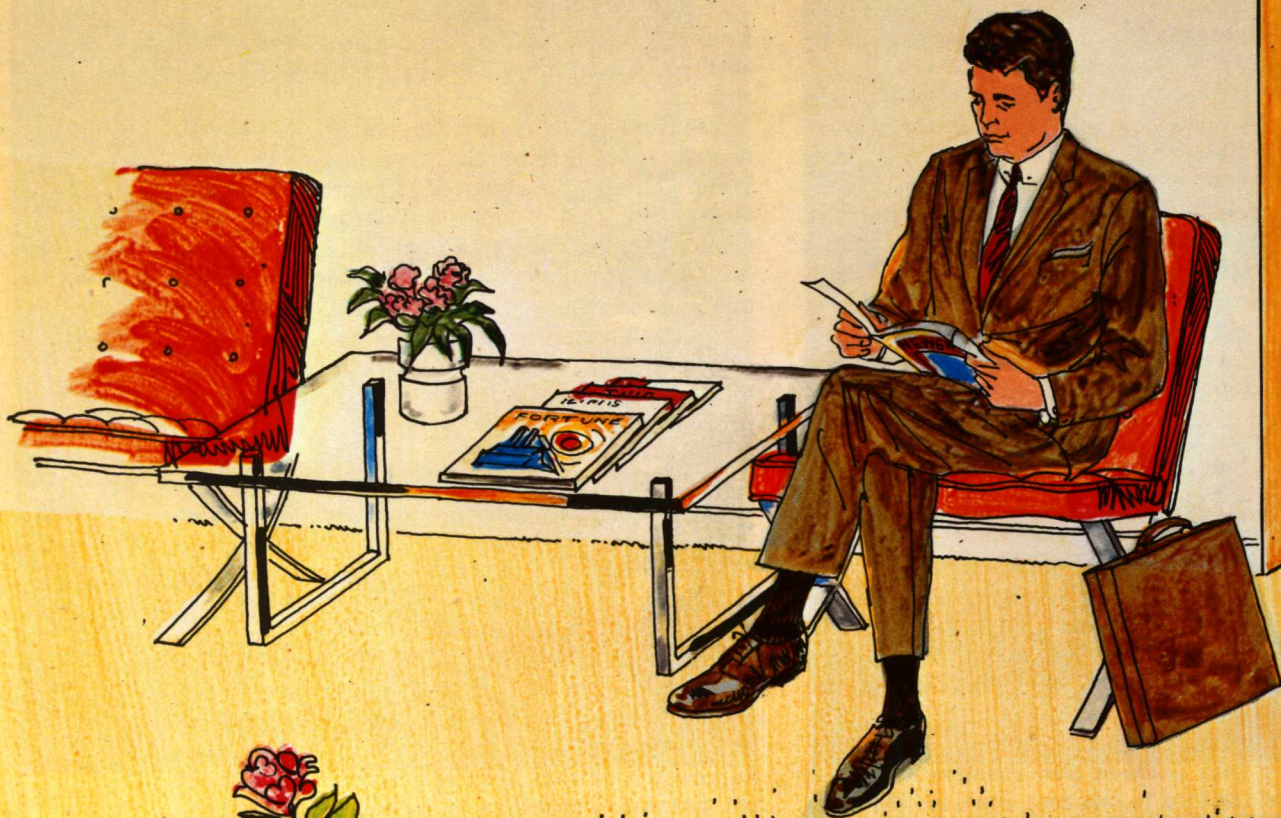

The first customers for Picturephone set-vice will likely be business and industrial enterprises, where the usefulness is readily apparent. The service can be added to business telephone systems with some changes to present PBX and key telephone equipment.

Video Service for Business

J. R. Harris and R. D. Williams

SOME BUSINESS CUSTOMERS have simple, single-line telephone service much like residential service. Others have special switching arrangements, either Private Branch Exchange (PBX) or centrex, and many are equipped for key telephone service. (Centrex is a type of PBX service with additional inward and outward dialing features. Key telephone service means pushbuttons on telephone sets to select additional lines and perform other functions.) Together, these arrangements provide a broad array of telephone service features: attendant assistance, multiple lines with "pickup and hold," hunting from a busy line to a secretary, consultation hold, conference calling, call transfer, intercom, off-premise extensions, and many more.

PICTUREPHONE® service is a major new Bell System service to be added to those now provided by the major dial PBX and centrex systems serving the business community. For the most part, the current systems are step-by-step and crossbar PBX switching systems. These will supply PBX and centrex telephone service for several years to come until electronic systems eventually displace them.

Let's look at what the business customer will see and do in making a Picturephone call, what

broad plans have been made for adding Picturephone service to the various types and sizes of telephone equipment, and what development projects are now underway.

Initially, Picturephone service will be offered to any customer served by selected No. 5 crossbar switching offices. Customers will place and receive Picturephone calls much as they now do regular telephone calls. With centrex service, incoming video calls can be connected directly to the Picturephone set; with either centrex or PBX service, calls can be switched to the set by an attendant. Picturephone display and control units can be supplied for the attendant if the customer desires, so that the attendant can see and be seen. Another option would display a fixed video image, such as the customer's trademark, to the caller while the attendant is working on the call.

A new duty of the attendant will be to recognize when an incoming video call is directed to a non-video station and to notify the calling party that the video portion of the call cannot be completed. A question of best procedures arises when the caller requests that the call be completed to a voice-only telephone. Systems will permit such a connection, but charging will continue as if for

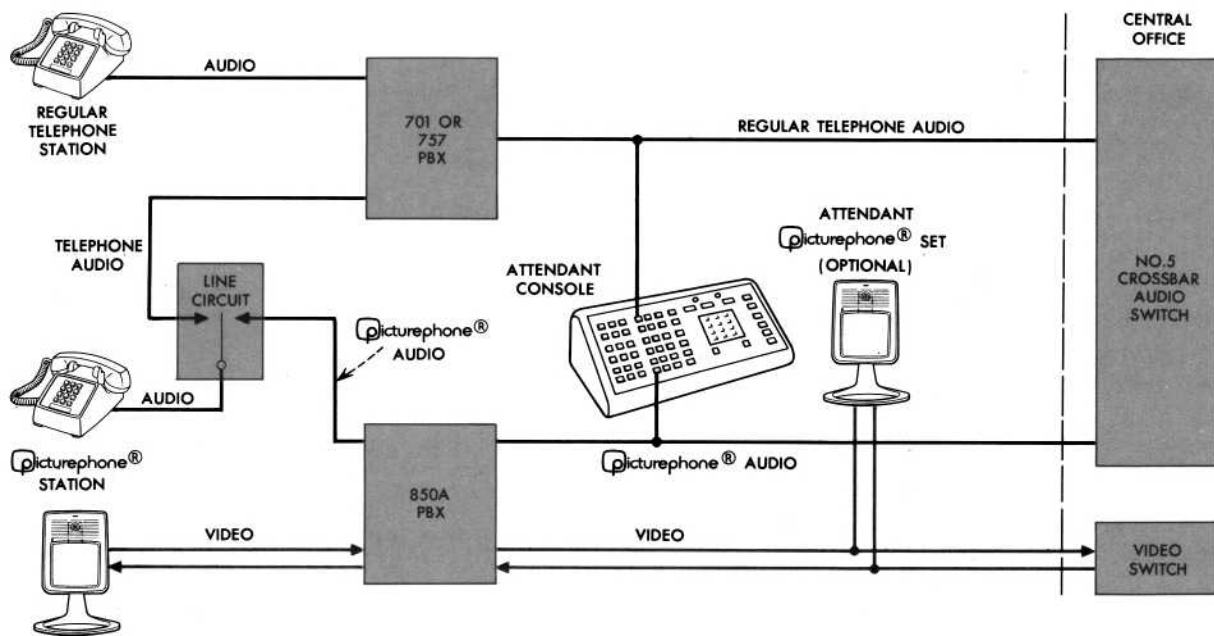

A new 850A PBX, operating in parallel with an existing 701 or 757, will add Picturephone service for business customers. Both audio and video portions of Picturephone calls are handled by the

850A PBX. Voice-only telephone calls continue to be switched by the regular PBX. Video and voice-only calls may be handled by the attendant; Picturephone sets at the attendant's position are optional.

Picturephone service. A video call dialed directly to a nonvideo line, however, will not be completed.

When a call involves more than two parties equipped for video, there is no immediately obvious answer to the question of who should see whom. In general, the party who has set up the three-way connection determines who will see whom (see table on page 153).

We expect that executives of medium and large businesses will be among the first customers for Picturephone service. Most of these customers are currently being served by the 701 step-by-step or 757 crossbar systems. Other customers are served by No. 5 crossbar centrex (see *Choosing the Route*, this issue).

To add Picturephone service to the 701 and 757 PBX's, Bell Labs has designed a new Picturephone switching system, designated the 850A PBX, which operates in parallel with the existing PBX (see figure on this page). The system includes the service features generally available with other PBX and centrex systems. The PBX for Picturephone service uses the electronic technology exemplified by the 800A PBX (see *Electronic Switching For Small PBX's*, RECORD, February 1967).

A new video line circuit connects each Picturephone line to both the 850A PBX and the regular PBX. When a call is placed, the line is connected to a register in the 850A PBX and to a line finder or register in the regular PBX. Picturephone calls are initiated by dialing the character, #, on the 12-button TOUCH-TONE® telephone, followed by a normal telephone number. The # character causes the video switching system to dismiss the regular PBX and to apply a busy indication to the line appearance in that system. Both the audio and video signals are then handled by the 850A PBX. Alternatively, if the called number is not preceded by the dial indicator, #, the video switching system is dismissed and a busy indication is applied to its line appearance. The call is then handled in the usual manner by the regular PBX.

Interface between the regular telephone system and the video switching system appears at three points (see figure above). The line circuit interface involves only the talking pair and a supervisory lead for each line equipped for Picturephone service. An interchange of signals is also required for the attendant circuitry, which is shared between the two systems, and for the call transfer circuits so that Picturephone calls can



Bell Labs' Robert Stromberg tests switching circuits in the new 850A PBX, now being developed.

be transferred to a voice-only line. The video switching system is connected to the serving of office over special six-wire trunks.

Two parallel four-wire ferreed switches are used to switch the combined audio and video signals for Picturephone calls. Crosspoints are mounted on new printed wiring boards designed to plug into carriers, which in turn are mounted on a framework similar to the existing PBX. The new PBX will serve a maximum of 90 lines.

When Picturephone service is added to a 701 or 757 centrex system, calls dialed directly to the outside must be automatically identified (AIOD), since no provision is being made for operator identification. The 850A PBX will operate with the MOD system available for the 701 and 757 PBX's.

No. 101 electronic switching systems (ESS) are

servicing a growing number of customers. It is relatively simple to add the video capability to PBX and centrex services provided by No. 101 ESS. A new four-wire wideband switch unit, which operates in parallel with the existing No. 101 ESS switch unit, will be added to switch the video portion of the Picturephone call (see upper figure on page 152). It will be capable of serving 150 or more Picturephone sets. The program in the control unit will control this switch. The audio portion of the call, as well as all supervisory functions, will be handled by the regular 2A, 3A, or 4A switch unit in the normal manner. This arrangement uses the existing switch unit in handling data messages to pass control information back and forth between the control unit and the video switch.

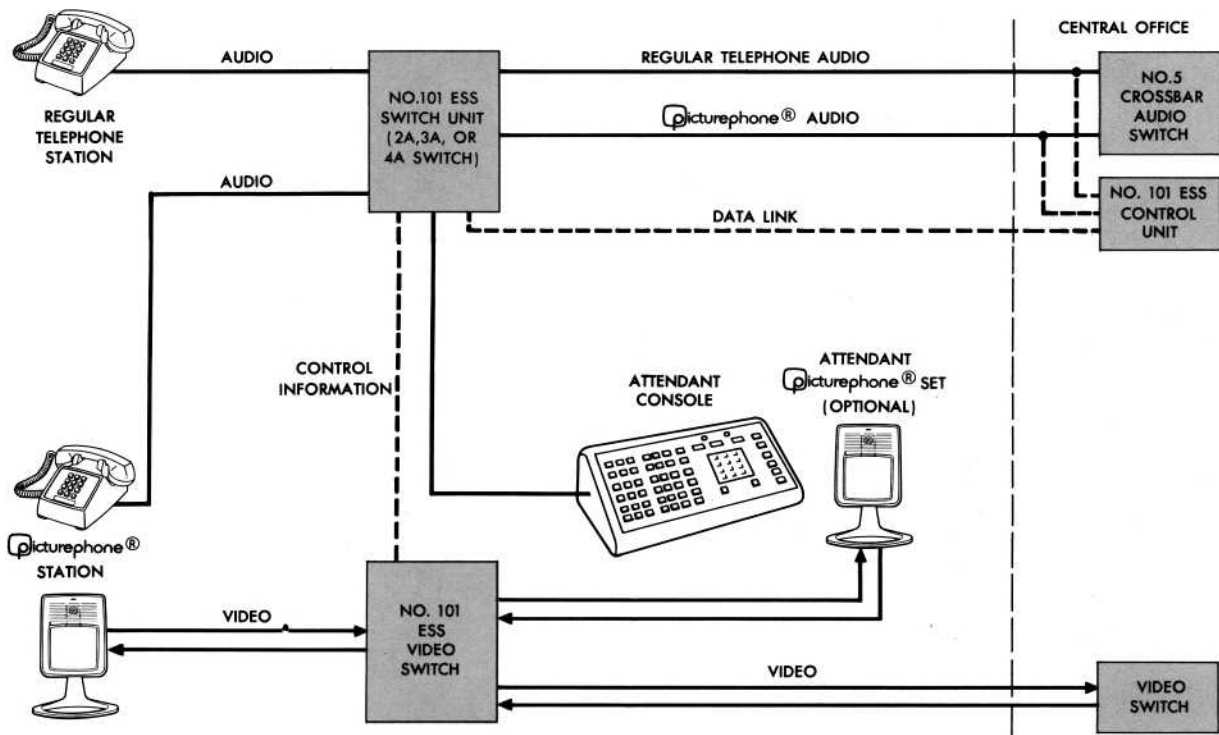

A new video switch, operating in parallel with the existing 2A, 3A, or 4A switch, will add Picturephone service to the PBX and centrex services al-

ready provided by No. 101 ESS. The existing data link (s) will be used for control of the video switch by the stored program in the Ess control unit.

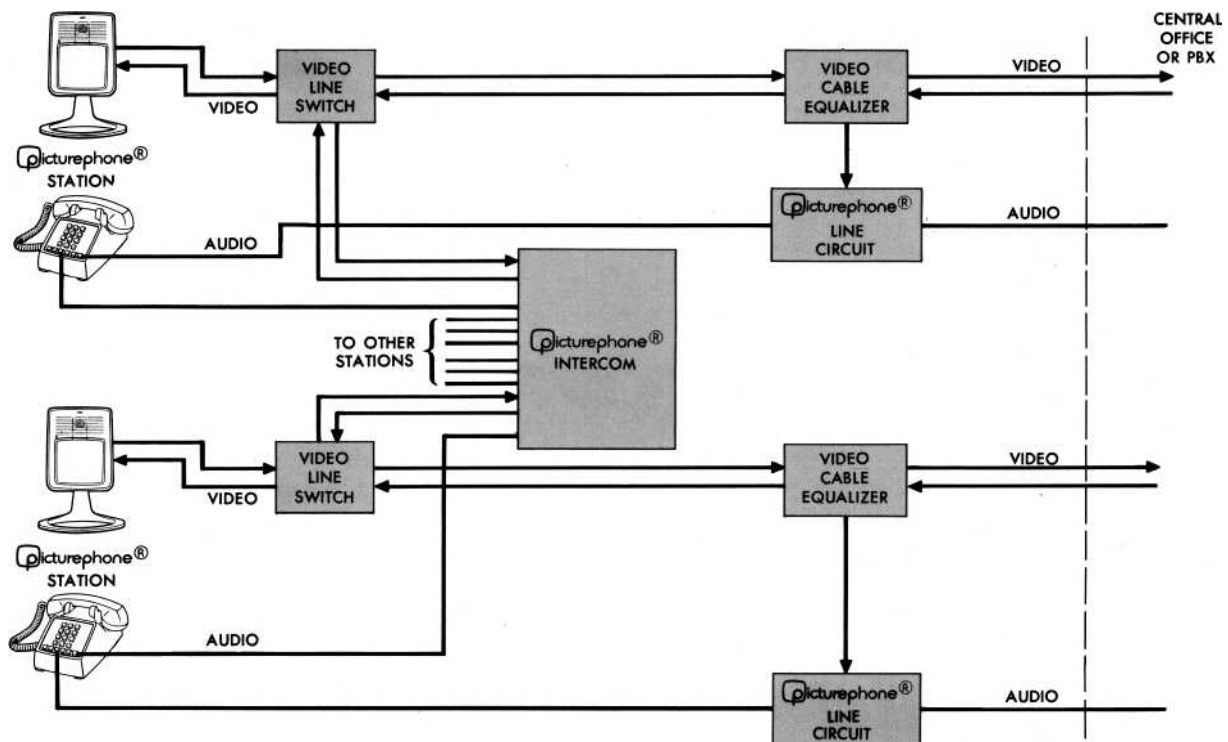

Key telephone service will be used with PBX lines and with central-office lines. In either case, each key set can be served by one or more video lines,

intercom lines, and regular telephone lines. When used with a central-office line, a Picturephone intercom provides internal video communication.

The wideband video switch uses standard, four-wire, 8-by-8 ferreed switches, packaged in modules which can be added to the switch unit in the field to increase the capacity of the system. This "add-on" type of growth encourages even distribution of traffic. The video switching network and associated control will be packaged in cabinets compatible with existing switch unit cabinets.

Further in the future, the 810A PBX, currently being developed, will be designed to allow Picturephone service to be added when desired by the customer.

To add the video dimension to the usual types of key telephone service and to take care of certain special situations as well, a new six-wire video key telephone system, belonging to the 1A2 family of key systems, is being developed (see *Key Telephone Systems: The Latest Chapter, RECORD, March 1966*).

A feature of the key system (see lower illustration on page 152) will be a single-link intercom accommodating up to ten Picturephone sets. Calls to any set on the intercom will be made by dialing the character, #, plus one other digit corresponding to the called station. A multi-link intercom is under consideration.

The key telephone system will include an add-on conference arrangement to operate with central office, PBX, or intercom lines. The conference unit will be similar to that provided for regular telephone service, but only one video connection will be made at a time (see table on this page).

Video repeaters and synchronizing circuits-together with the usual lamp, holding, and audible signaling circuits-are required in the key telephone system to add Picturephone service. An enlarged key service unit is planned to house this equipment. This unit will accommodate two lines plus the equipment needed to switch the Picturephone set. The switching circuitry responds to the pick-up key in the telephone set and performs the same function for video calls that the key performs for audio calls. A four-line package, which provides four individual lines or two "boss-secretary" arrangements, will also be available.

In situations where the customer's telephone is served directly from the central office, he may elect to use key telephone service with central-office Picturephone lines. Each key telephone set can be served by one or more video lines to the central office, video intercom lines, and regular telephone lines.

When only a few people served by a PBX require Picturephone service, they can be connected directly to the central office, rather than to the PBX,

TYPE OF SERVICE	PARTY CONTROLLING SERVICE SEES	PARTY A SEES	PARTY B SEES
Key Telephone Add-On	Choice Of A Or B, Changeable At Will	Party Controlling If A Was Chosen, Otherwise Blank	Party Controlling If B Was Chosen, Otherwise Blank
PBX/ Centrex Add-On Or 3-Way Calling*	Party A	Party Controlling	Blank
3-Way Connection Including Attendant (Who Controls Service)		Party B	Party A

***These video services will be available with series 300 and centrex II service. The controlling party must be a PBX or centrex station (never an "outside" party). Party A is the noncontrolling party first on the connection. The controlling party can add party B by flashing and dialing party B's number.**

With Picturephone service, the communication system must play a part in control of who is seen in a three-party conference.

using key system arrangements just described. In this case the Picturephone number will usually not be the same as the PBX or centrex extension number. On outgoing calls the customer will select the video line to place a call by pressing an appropriate line button.

In the initial offering, Picturephone service is not planned for off-premise extensions, tie lines, or interoffice channels used in common control switching arrangement (CCSA) services. In the future these services and new ones may be added. For example, the utility of video conferences might be improved. To this end a new voice-activated conferencing system is being explored. With this arrangement the speech activity of the conferees controls who sees whom.

Compatibility with the Bell System's PBX, centrex, and key telephone system service features, together with maximum use of existing switching capabilities and ease of installation and growth, have been the objectives of the PBX and key telephone Picturephone planning and development.

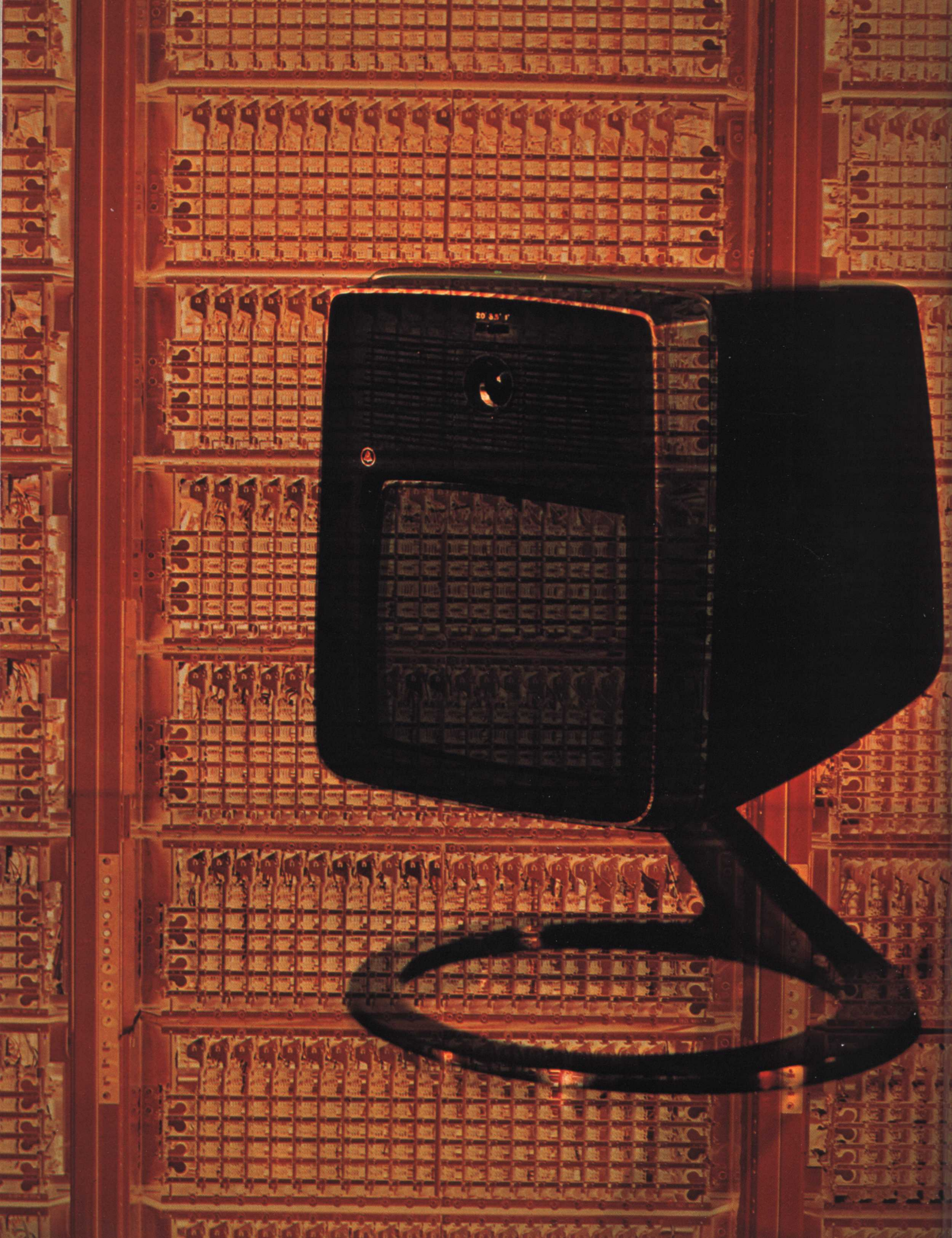

As Picturephone service supplements conventional telephone service, switching arrangements for video calls will be integrated with existing switching systems - initially with No. 5 crossbar and later with No. 1 ESS - in the simplest and most direct way possible.

Choosing the Route

F. A. Korn and A. E. Ritchie

THE DECISION to integrate PICTUREPHONE® service with voice features leads directly to the conclusion that the two must be combined in existing local central offices. Thus, customers in an area will most likely receive Picturephone service from the same office that provides conventional telephone service. These customers will be connected to the local office by the usual two-wire loop for voice, which can be used independently, and a separate four-wire loop for the picture, which can be used only with a voice loop.

On the outgoing side of the office, the voice and picture transmission facilities will be combined in a six-wire trunk and will never be used independently. For long-haul (or toll) connections, switching offices beyond the local level will be arranged in a hierarchy similar to that now employed for telephone traffic. Since the Picturephone signal will be converted to and maintained in digital form as it is transmitted over more than local distances, the toll offices will have digital switching equipment.

Within the local office to which the customers are connected, a separate video switching network is added, parallel with the existing voice network, to interconnect Picturephone calls. This video network is called into play only when a Picturephone call is recognized. Remote switching is used wherever possible to reduce the high costs associated with long video loops.

Achieving the desired close relationship of voice and video makes it desirable to use the same telephone number for both services. This, in turn, requires the use of a special indicator to differentiate video calls from voice-only calls. The choice of indicator is the twelfth button (#) of the TOUCH-TONE® telephone, used as a prefix, thereby tying together Touch-Tone and Picturephone services. The simplicity and economy of this signaling method easily justifies the tie-in, particularly in view of the long-range plan to

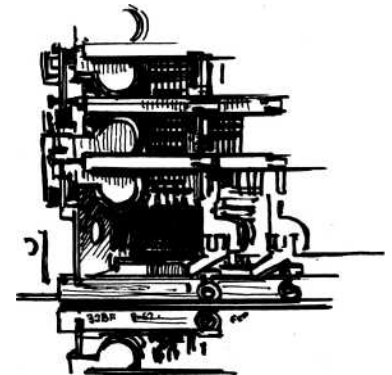

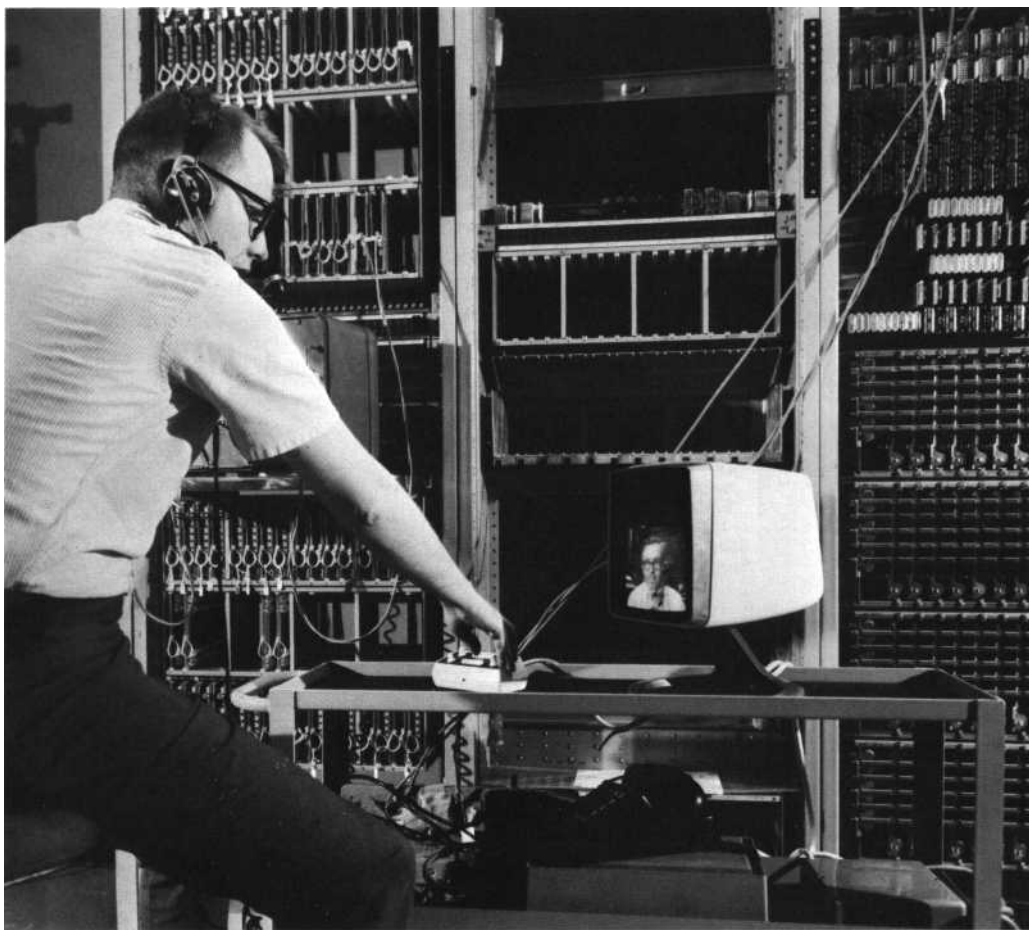

At a No. 5 crossbar central office in New York City, switchman W. R. Ackerson of the New York Telephone Company and co-worker J. N. Palmer (on screen) check operation of the Picturephone system currently being tried out by the Westinghouse Electric Corporation between its offices at New York and Pittsburgh, Pennsylvania.

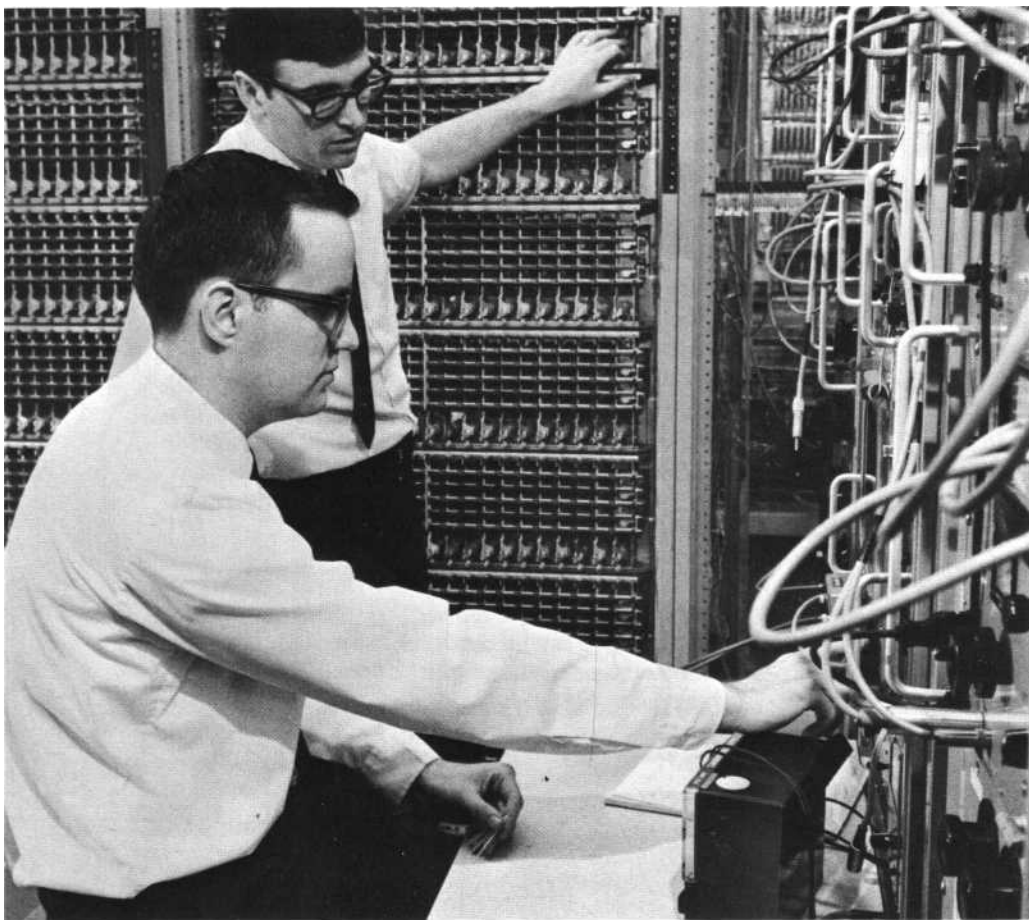

P. N. Burgess and R. E. Lahr of Bell Laboratories measure the transmission characteristics of a wideband switching network which simulates the more than 12 million paths available in a No. 5 crossbar office offering Picturephone service. These tests were carried out at the Columbus Laboratory in preparation for the standard Picturephone service planned for the 1970's.

Any one of these false conditions could cause degradation of the video signal.

Upon completion of the FCG test, the marker applies a second continuity check to the calling customer video loop. Finally, before releasing from the call, the marker causes the outgoing trunk to apply a 100-millisecond burst of a Video Supervisory Signal (vss) on the video pair toward the calling customer, turning his Picturephone set on. The signal consists of the same series of pulses that make up the horizontal and vertical sync pulses in a normal video signal but without the usual picture information.

At the terminating office, similar actions occur, but with a few differences. For example, only a single check of the connection is made since the trunk to the receiving office has already been tested and only the loop to the called station need be checked. In addition, vss is applied continuously toward the called station, starting at least 100 milliseconds before ringing begins. The combination of vss and the ringing signal causes the station set to give a distinctive ring, indicating a Picturephone call, and turns the set on when the customer answers.

Some readers may wonder at this point whether crossbar switches, originally designed to pass audio signals up to 4 kHz in bandwidth, can handle video signals 250 times greater in bandwidth. They might also wonder whether the high-frequency noise generated by the operation and release of hold-and-select magnets creates intolerable interference with the video signal. These same questions were raised early in the development of the Picturephone system. A concerted effort by system, circuit, and equipment engineers, as well as an extensive testing program to verify the designs, helped answer them. Specifically, it was necessary to learn about and reduce the effects of: the transmission insertion loss of the network over the 1-MHz band, the "self-cross-talk" properties of the network (i.e., crosstalk between the transmit and receive pairs of the same channel), the crosstalk from other video signals, and the noise caused by relay operations in a central office.

Simply using equalizers to reshape video signals distorted by the network would not work because the distortion of a signal would vary from call to call due to the differences in cable length through the various paths or channels in the network. Since this variability cannot rea-

sonably be compensated by using fixed equalizers, a controlled floor plan for the wideband network in the central office has evolved. The three-stage video switching network is thus arranged physically so that variations in path lengths are held to unusually precise limits: 160 feet, plus or minus 40 feet, from the wideband distributing frame through the three link frames to the trunks, and 160 feet, plus or minus 10 feet, from the trunks back to the distributing frame.

Because the electrical distance between the equalizers and network is relatively constant, the design of the equalizers can be based on a fixed cable loss and appropriate shaping. All signals coming from an equalizer to the network pass through the wideband distributing frame at a predetermined level, making it possible to interchange equalizers and network terminations for such purposes as traffic balancing. All signals coming from the network to the equalizers pass through the distributing frame at a lower level, determined by the frequency-shaping characteristics of the controlled cable and network.

Further steps taken to improve transmission characteristics through the office include: using shielded cable for all transmission pairs between frames, separating each direction of transmission into two separate cables, and separating the do control leads from the transmission pairs. A network with these constraints was built and tested. Also, system studies were conducted to give numerical limits to the transmission impairments described earlier, and to determine how each of the impairments could be allocated to each portion of the transmission path from Picturephone set to Picturephone set. The results of the testing program showed that the network will comfortably meet its allocation.

With the anticipated growth of Picturephone service, the No. 5 crossbar system will be expected to provide new switching abilities. In the immediate future, there is need to provide bit stream, or digital, switching arrangements for handling the interconnection of calls above the local office level. Another need is for additional customer features such as individual call transfer arrangements within a centrex group. These services are being planned now.

For the longer range future, plans are being formulated to switch Picturephone service with No. 1 ESS and to provide better concentrator facilities in the customer loop plant.

The Evolution of Picturephone Service

Some recent milestones in the development of the PICTUREPHONE® system are summarized pictorially on these pages (photos from *The Evolution of Picturephone Service*, RECORD, October 1968).

1956 By this time, Bell Labs scientists had developed several experimental "video telephone" systems of varying size and appearance which offered commercial possibilities. The one shown here was demonstrated before the Institute of Radio Engineers on August 23. This was the first system to transmit and receive recognizable pictures over ordinary telephone wires.



1957 Studies and experiments continued at Bell Labs to develop an economically feasible videotelephone system. Experiments similar to the one shown here helped engineers establish such picture standards as resolution, contrast, and other features. By 1959, plans were made to develop a videotelephone system specifically for the purpose of conducting trials.

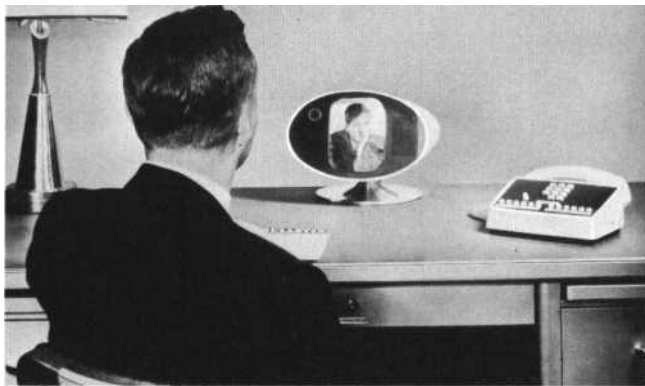

1963 A complete experimental Picturephone system had been developed. The station set included the camera-receiver-loudspeaker unit and the separate combination telephone set-video control unit.



1964 The first public exposure of Picturephone service was made at the New York World's Fair. Visitors, selected at random, tried the service for about 10 minutes each. Results of interviews conducted at the conclusion of each trial provided valuable information on early public reactions to the service.



1964 *Limited commercial Picturephone service between public locations in three cities-New York, Chicago, and Washington, D. C.-began on June 25. The service was inaugurated with a call from Mrs. Lyndon B. Johnson in Washington to Bell Laboratories scientist Dr. Elizabeth A. Wood, at the Picturephone center in Grand Central Terminal, New York. Robert F. Wagner, then mayor of New York, is seated at right.*



1965 *As a result of earlier trials, significant equipment and operational changes were made in the Picturephone system. The modified equipment was used in a product trial begun in July 1965, in cooperation with Union Carbide Corporation. In December of the same year an experimental trial began at AT&T headquarters in New York City. In June, 1967, the trial was expanded to include three Bell Labs locations. This trial integrated Picturephone service with normal telephone service. This "corporate network" offered an opportunity to explore additional uses for the system, such as the feasibility of using the Picturephone set as an interface between man and computer (shown here). The computer is interrogated from a Touch-Tone® dial, and results are displayed on the screen.*

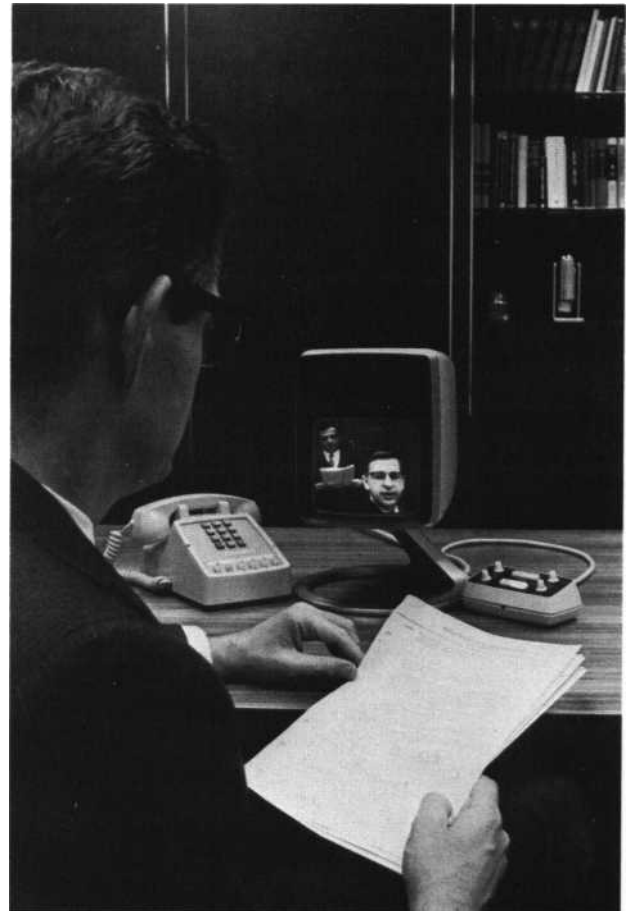

1968 *The Bell System's Picturephone "see-while-you-talk" set has been redesigned to incorporate additional features as a result of the extensive trials. The improved "Mod II" set shown here is itself now the subject of further trials as the evolution of Picturephone service continues.*

Transmitting Picturephone signals across town and across the country takes advantage of the versatility of today's nationwide communications network. Digital systems to be introduced in the future will greatly increase transmission efficiency and versatility.

Transmission Across Town Or Across the Country

D. W. Nast and I. Welber

THE BELL SYSTEM NETWORK has come a long way since the first telephone customers were connected over the simplest form of transmission system-wires. Today, the transmission network is a complex aggregate of electronics gear and the transmission medium (wire lines, coaxial cables, and radio paths). Together, they provide a multiplicity of channels over which many customers can communicate. New and more complex services and equipment are continually being added to the network without disrupting or impairing its ability to handle the many and varied existing communication services. The introduction of PICTUREPHONE® service is no exception. Adding Picturephone service to the network makes it more versatile and potentially useful for a variety of wideband communication services.

Basically, the transmission objectives for Picturephone service are to transmit high-quality voice and video signals and to maintain this quality from one call to the next. One criterion in fulfilling this objective is to make the audio portion of a Picturephone call at least as good as it is in the present DDD network. Because we ex-

pect that customers will normally use a form of speakerphone during a Picturephone call, the acoustics of the customer's office or home may affect the quality of the audio signal. Thus, control of echo and loss has been given special attention in engineering the network.

The greatest challenge, however, is the video transmission. To assure adequate picture quality, stringent requirements have been placed on such transmission characteristics as amplitude and phase deviations, single-frequency interference, random noise, crosstalk, switching noise, gain variation, low-frequency response, and power hum. As an example, for each trunk, interfering signals from power lines must be at least 45 dB below the desired signal. The requirements have been set to assure satisfactory performance on connections involving up to six analog trunks in tandem.

The Picturephone signals, both audio and video, arrive at the local central office in analog form over six-wire "loops"-two wires for audio and two wires for each direction of the video portion. Special six-wire trunks are then used to

carry the call outside the local area. Baseband analog transmission is used over exchange trunks less than six miles in length. For longer exchange trunks and toll trunks, analog transmission could also be used, but it would not be a very practical solution, economically. Although the analog requirements for long-haul Picturephone transmission could be easily met by using an entire TD-2 channel, just as for television, this would be prohibitively expensive. And it is not possible to put together an efficient combination of analog video signals without suffering greater impairment than is allowable on long trunks.

What is the solution? It turns out to be more economical for most of the longer exchange trunks, and for toll trunks, to transform the analog signal to digital form, and convert it back to analog at the distant terminal. And this is easy to do, since digital transmission in the Bell System is evolving rapidly. There are two very important characteristics of digital transmission that ideally suit it for this application. First, the digital signal can be regenerated so that the impairments are not a function of distance. Secondly, once they are in digital form Picturephone, telephone, and data signals can be efficiently intermixed on the same transmission facility. By taking advantage of these characteristics, line impairments—error rate and pulse jitter—can be so controlled that their effects on the Picturephone signals are essentially imperceptible.

Information can be sent in a digital format over transmission systems that use frequency-division carrier techniques for carrying several signals simultaneously. Sending voiceband data over the switched DDD network is an example. Digital information can also be sent over systems using time-division techniques for handling several pulse streams at one time. The T-1 system, for example, with its pulse stream of 1.5 megabits per second (Mb/s), is the Bell System's most widely used system that is inherently digital in its makeup. But its capacity isn't sufficient to handle a Picturephone signal. However, the T-2 carrier system, a member in the same family to be introduced shortly, carries a 6.3-Mb/s signal. The Picturephone signal can be adequately represented using this bit rate. Although a higher bit rate would have made it easier to get the desired performance, it would have been extravagant from a transmission point of view.

With the decision to use the 6.3-Mb/s rate came another one—to limit the encoding to a single step (i.e., once the signal is in digital form it stays in this form until it reaches the analog

connecting line at the far end). The toll network used for Picturephone service can be administered to avoid multiple encodings by appropriate engineering of the switching hierarchy.

Encoding the Picturephone signal into digital form at a 6.3-Mb/s rate raises the question of optimum format. Before we can answer that question we must know something about the

Ralph Graham, of AT&T's Long Lines Department, checks the operation of the digital terminal developed for the TD-2 microwave system. This terminal handles signals for the trial now in progress between Westinghouse Electric Corporation's offices in New York City and Pittsburgh.



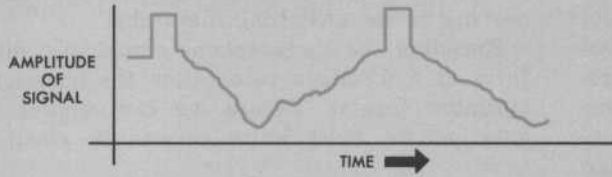

(A) ORIGINAL ANALOG SIGNAL



GENERALIZED PCM SYSTEM

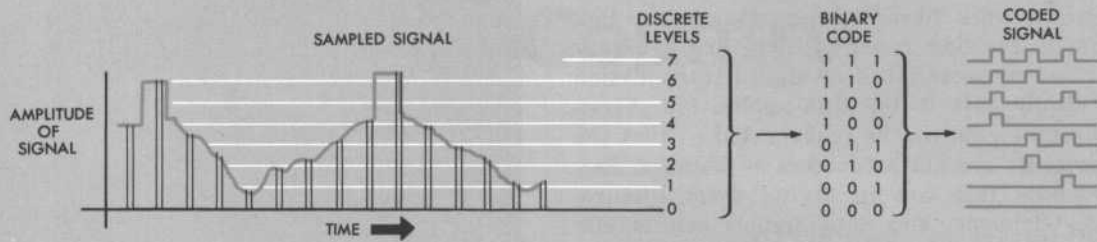

(B) PCM SAMPLING AND BINARY CODING

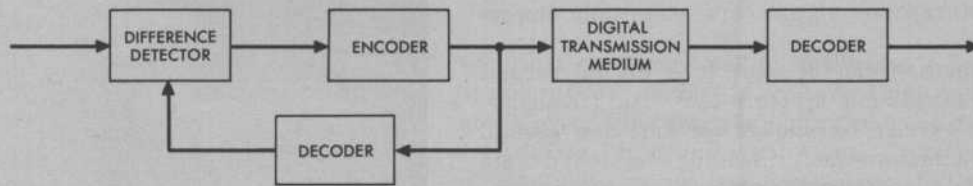

DIFFERENTIAL PCM SYSTEM

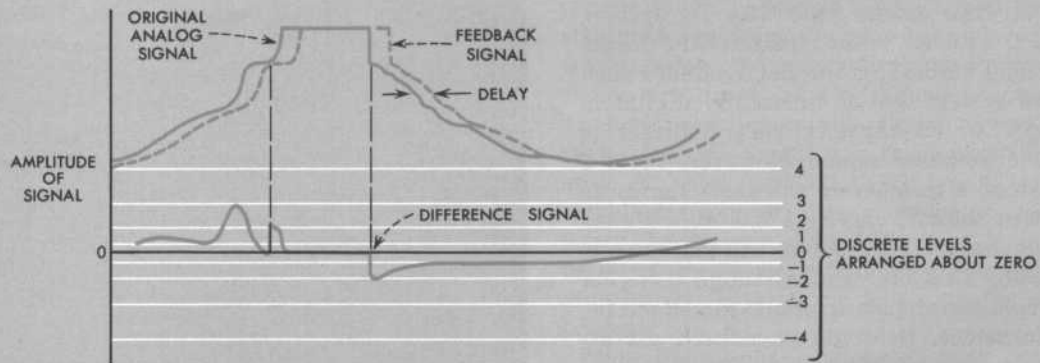

(C) DIFFERENTIAL PCM SAMPLING

(Refer to (A) on previous page.)

Picturephone signals are encoded into digital form for transmission over long distances using a "differential PCM" system. The Picturephone signal (A) is an analog of the picture material.

(Refer to (B) on previous page.)

Encoding the analog signal into a pulse stream with a standard PCM system (B) would result in an excessively grainy picture. The 1-MHz video signal is sampled at a 2-MHz rate. Three binary digits are used to code the samples. But with three digits only eight discrete levels can be encoded, which for purposes of this example are divided equally over the maximum amplitude of the signal. The use of only eight levels for sampling a continuous signal results in the graininess.

(Refer to (C) on previous page.)

The differential PCM system (C) appreciably reduces graininess by taking advantage of the unique characteristics of the signal-i.e., most of the energy is below 50 kHz and the amplitude changes very little. Here a delayed signal, produced from a PCM decoder in a feedback loop, is subtracted from the original signal. Most of the eight discrete levels are arranged to represent the region of the difference signal around zero; fewer levels are used for larger difference signals. Although the reproduction of a picture coded in this way is still grainy, tests have shown that it is far superior than one coded by straight PCM.

form of the signal itself. Take the energy content of the signal, for example. Imagine a special power measuring device that measures the power in a narrow frequency band. If we were to measure the energy content of the signal in narrow steps from very low frequencies (dc) to 1 MHz as a function of time and average each reading over the time interval, a plot of the results would show that most of the energy is contained below 50 kHz. Moreover, the curve would show that for much of the time the signal is hardly changing at all, or if it is changing rapidly and introducing high frequencies, it is not doing so very often. These properties, as we will see later, are used in deriving an efficient digital coding scheme for Picturephone signals.

To encode the 1-MHz video Picturephone signal into the T-2 rate of about 6 Mb/s takes two basic steps: sampling and coding. Samples of the video signal must be taken at a rate which is at least twice the highest frequency we wish to reproduce. This is a fundamental law of communication. Thus, if we wish to reproduce a picture with resolution up to 1 MHz, we must sample the amplitude of the original signal at least at a 2-MHz rate. Limiting the transmission rate to 6 Mb/s means we are restricted to three binary digits per sample. However, three binary digits mean that the total amplitude range of the signal must be represented by only eight discrete levels (see B at left).

So far we have done two things-one beneficial and one restrictive. We have substituted a signal that is either on or off for one that previously had a continuous range of values-this is beneficial since a two-valued signal can be reliably reproduced with no loss in information as long as the on pulse can be distinguished from the off pulse. The restrictive effect is that the signal is now represented by only eight levels, where before sampling and coding it was continuous. This effect produces a graininess in the picture which most people would find quite objectionable. To overcome graininess, a process called differential PCM is used. This process takes advantage of the fact that most of the energy in the signal is below 50 kHz, and the amplitude is hardly changing at all.

The encoder used for differential PCM (see C at left) employs a PCM decoder in a feedback loop which produces a signal that is delayed by a small amount from the original. The delayed signal, when subtracted from the original, produces a difference signal. When the original signal is changing slowly or not at all, the difference is zero, or nearly zero; when the signal is changing

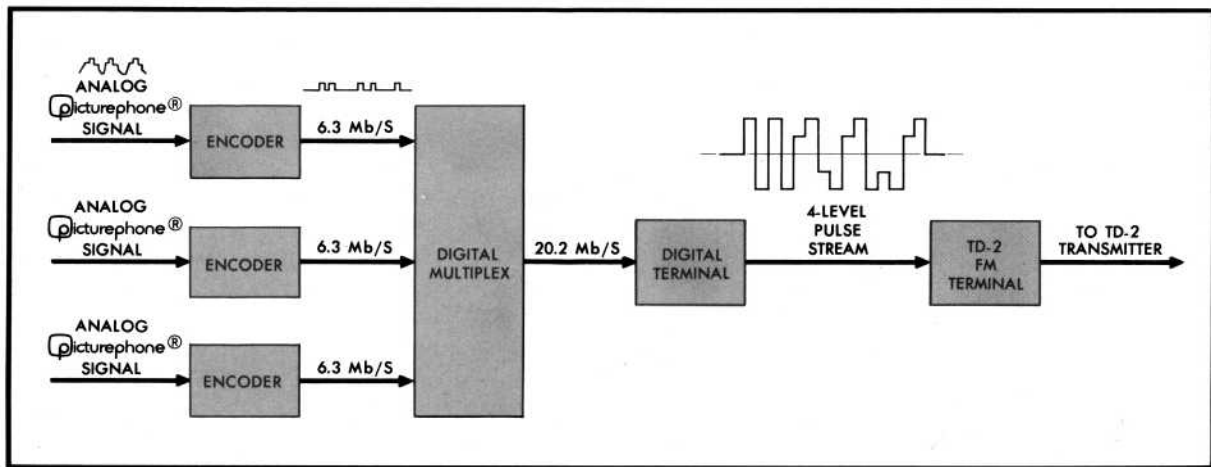

For the present, and until the early 1970's, TD-2 microwave radio is one, of the two means for transmitting Picturephone signals over long distances. To do this, a special digital multiplex and a digital terminal were developed to encode up to three Picturephone signals on one TD-2 radio channel. The digital multiplex combines

the three 6.3-Mb/s Picturephone signals plus the required synchronizing and framing pulses into a 20.2-Mb/s signal. The digital terminal converts this signal into a high-speed, four-level pulse train. The FM terminal transforms the pulse train into a frequency-modulated wave, which is sent to the TD-2 microwave radio transmitter.

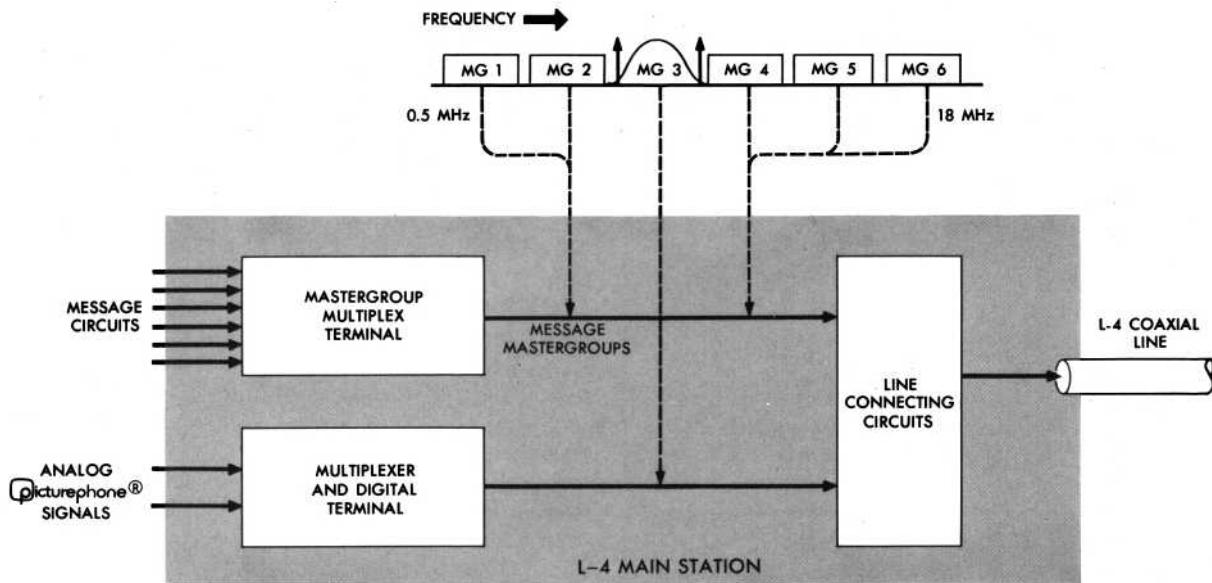

A special digital multiplex and terminal is being developed to permit the L-4 coaxial cable system to carry digital Picturephone signals over long distances. The signal produced by the terminal used with the L-4 system is a pulse stream with

eight-level pulses instead of the four levels used in the TD-2. Two digital Picturephone signals, applied to the L-4 system, can occupy the frequency band normally used for any of the L-4 mastergroups except the bottom mastergroup.

rapidly, the difference is large. At this point we take advantage of the fact mentioned earlier that most of the time the signal is changing slowly, and thus, most of the time the difference signal would be near zero. This being the case, we can arrange the eight coding levels so that most of them are used to represent the region around zero. Fewer levels are used for the larger difference signals. The reproduction of a picture coded in this way is still subject to some graininess when the signal is changing rapidly, such as a rapid change from black to white or vice versa. However, the results of subjective tests performed with a coder of this type are far superior than for a straight Pcm coder.

The digital transmission system that will carry the signals between distant points can assume a variety of forms. For the present, and until the early 1970's, TD-2 microwave radio and the L-4 coaxial cable system will handle most Picturephone signals. The T-2 digital carrier system, first of the toll digital systems scheduled for introduction in the early 1970's, will carry Picturephone signals, where appropriate, over interexchange trunks for distances up to several hundred miles. Still further in the future, the L-5 and T-5 coaxial cable systems and eventually millimeter waveguide will be available for long-haul transmission of Picturephone calls.

Since the TD-2 and L-4 systems are designed around frequency-division carrier techniques, they require special terminals to permit digital signals to be transmitted efficiently. The special digital terminal developed for the TD-2 (see upper figure on facing page) will enable up to three encoded Picturephone signals plus the required synchronizing and framing pulses to be carried on one radio channel. The bit rate on the radio channel will be 20.2 Mb/s. The format of the signal applied to the TD-2 channel consists of the 20.2-Mb/s digital pulse train with each pulse having four possible levels. A single pulse, therefore, carries two information bits, and the pulse rate on the channel is 10.1 million pulses per second. Evaluation of the performance of this system shows it to be highly satisfactory. Even when the radio channel undergoes selective fading and is about to switch to the protection channel, the maximum error rate in the digital signal is less than one in 100K. This produces a barely perceptible amount of noise in a Picturephone signal.

The L-4 coaxial cable system (see lower figure on facing page) is not subject to fading or large variations of noise level, and accordingly, the format of the digital signal is different. The signal

produced by the digital terminal being developed for the L-4 system is a pulse stream with eight-level pulses instead of the four levels used in the TD-2. In addition, a special signal format, known as "partial response" filtering, takes advantage of the properties of the coaxial cable. This format produces a spectrum with essentially no energy at the band edges of the mastergroup. (A mastergroup is a composite signal which carries up to 600 voice channels.) This is done to minimize interference into adjacent channels and to permit timing and synchronizing signals (pilots) to be placed at the band edges.

Two digital Picturephone signals, applied to the L-4 system, occupy the frequency band normally used to carry a single mastergroup. The L-4 system can carry six mastergroups. Any or all of the mastergroups may transmit encoded Picturephone signals, with the exception of the bottom mastergroup. The distortion introduced by the repeaters in the band set aside for the bottom mastergroup is more severe than in the other mastergroups, and the performance for digital transmission is, therefore, inadequate.

When only a few toll trunks are needed, TD-2 and L-4 systems will take care of these Picturephone requirements quite handily. But later when many such trunks are needed along a major route, new digital systems will provide the most economical answer. It works out this way: For message channels, the analog systems using radio and coaxial cable are very efficient, and even T-5, a family of digital systems for possible use on coaxial cable in about 1975, will probably be a slightly costlier way of getting voice circuits than will its analog cousin, the L-5 coaxial cable system. But the digital systems will have a marked advantage when it comes to handling Picturephone signals because of the tradeoffs involved. For example, a TD-2 radio channel can carry 1200 message channels but only three Picturephone channels—a tradeoff of one Picturephone channel for 400 message channels. Similarly, the L-4 system substitutes two Picturephone channels for 600 message channels, or one Picturephone channel per 300 message channels. In contrast, the T-2 carrier system, designed especially for digital transmission, will displace only 96 message circuits to carry one Picturephone channel. And future digital systems, such as the T-5 system, will have a corresponding advantage over future analog systems in efficiency for transmitting Picturephone signals.

The discussion thus far has covered the method used to transmit the Picturephone signal over long distances. We must also transmit the signal

over shorter distances (about six miles or less) between central offices. Transmission of Picturephone signals over this distance is in analog form over interoffice exchange trunks. The exchange cables can be as large as 1100 pairs of 22-gauge wire in one sheath and are presently used for two-way transmission of 4-kHz telephone channels. Trunk facilities are made up of six 6000-foot sections in tandem, and as many as four trunk facilities may be built up to complete a connection between central office switches. Transmission of a 1-MHz video signal over this medium with minimum degradation of the signal requires precise equalization. Thus, equalizers will be placed every 6000 feet, with power supplied over the same line.

The equalizer contains several networks that compensate for the distortion introduced by variation of attenuation with frequency in the cable. Equalizers are designed to have the equivalent attenuation of cable lengths of 3000, 1500, and 750 feet, thus restoring all frequencies to their original intensity. One network, which matches the characteristics of a 750-foot length, is variable to accommodate variations in the length of trunks, or variations in characteristics that can be equalized by an equivalent change in length. A temperature-regulation section is also included to avoid seasonal adjustments of the equalizers. The normal variation of cable temperature over the period of a year can cause the transmission to

change enough to give excessive distortion. In fact, a 5-degree change in cable temperature without a corresponding change in the equalizer setting will cause appreciable distortion. To compensate for this, a temperature regulating equalizer responds to changes in the level of a 1-MHz tone, applied to the trunk continuously.

The previous discussion assumes that the various pairs in a cable have the same loss versus frequency characteristic and the same temperature coefficients. This is not the case, and for this reason a "mop-up" equalizer, operating on the same 1-MHz signal used by the line equalizer, will be provided at the receiving office of each trunk. The 1-MHz tone is supplied continuously by each outgoing office equalizer. An additional 100-kHz tone, used at the incoming office to provide a second reference point for mop-up equalization and temperature regulation, is also supplied by the outgoing office equalizer, but only when the Picturephone signal is not present.

It seems certain that future work on transmission systems to carry Picturephone signals will be concentrated on increasing transmission efficiency. The introduction of new digital transmission systems in the 1970's will be a major step toward meeting this objective. In the meantime, our ability to send high-speed digital information over existing analog systems is a practical beginning for a digital network that can reach virtually every part of the country.

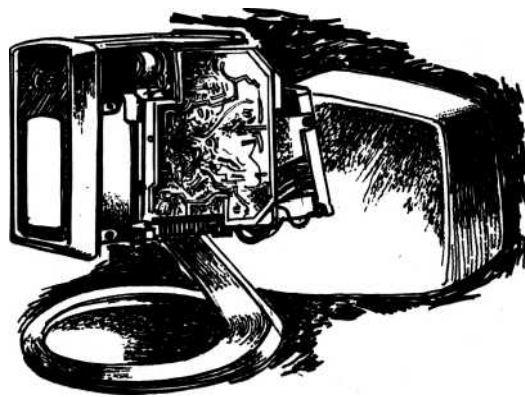

Telephones are connected to central offices over a vast network of aerial and underground wires called the customer loop plant. This network will soon carry video as well as voice calls, as the new Picturephone service evolves and becomes more widely used.

Connecting the Customer

F. T. Andrews, Jr., and H. Z. Hardaway

IN THE 1970's, PICTUREPHONE® service will be offered by the Bell System over existing customer loops, just as many special services are offered today. These wire networks, built up over the years primarily for economical voice communications, will soon take on the more stringent requirements of video transmission. While some changes will obviously be required, the loops will remain basically the same. Picturephone service will be incorporated by modifying existing loops, not by replacing them.

Adapting customer loops to accommodate Picturephone service depends upon a number of factors, including distance of customer from the office, age of wire facilities already there, proximity of interference sources, type of plant construction (aerial or underground), and the area being served (urban, suburban, or rural).

The existing loop plant consists of conventional wire pairs, each telephone line requiring one pair. For two-way video transmission, two additional wire pairs must be used, forming a six-wire

loop for two-way Picturephone service. The existing loops are designed for transmission of voice signals, which are in the 4-kHz frequency range. But the video frequency band is much wider—about 1 MHz—so that transmission losses are much greater, and some form of signal reconstitution is needed. This is where equalizers come in.

Adding equalizers is the most significant change required to adapt existing loops for Picturephone service. The equalizer is a basic requirement of Picturephone loops, providing gain equal and opposite to the loss of ordinary telephone cable pairs within tenths of a decibel across a frequency band from 1 Hz to 1 MHz. Determining how many equalizers should be added, and where, is essential to make best use of existing plant.

For example, there are practical limits to how long a section of cable can be handled by an equalizer at a given location. While separate pairs are used for transmitting video signals to and

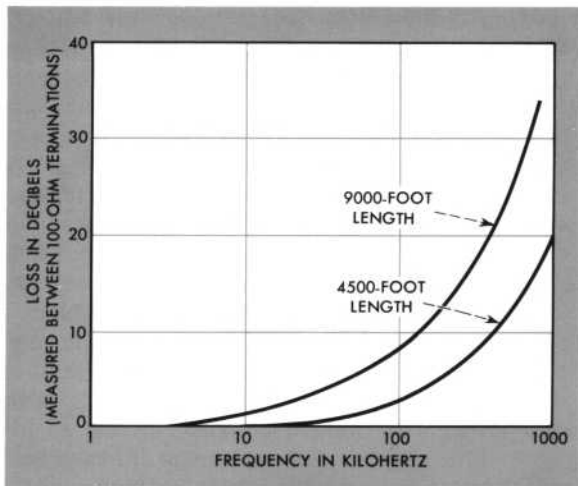

The need for equalizers in a cable carrying 1-MHz video signals is evident in this example of the loss of two lengths of 22-gauge pulp-insulated cable. For a given gauge, plastic-insulated conductor cable has somewhat less transmission loss.

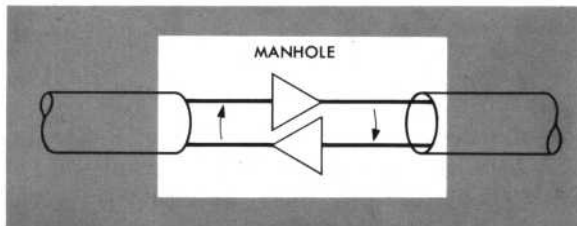

When equalizers for both directions of transmission are installed at the same physical location, there is some possibility that the output of one can feed into the input of the other via crosstalk paths (arrows) and cause "singing." This is prevented by keeping the combined gain of the equalizers from exceeding the combined loss of the crosstalk paths, using shorter equalizer spacing.

from the customer (in addition to a single pair used for transmitting voice signals in both directions), for practical reasons equalizers for the two directions are installed at the same physical locations along a cable run. As a result, the output of one feeds into the input of the other through the undesired but inevitable near-end crosstalk paths (see illustration on this page).

Should the combined gain of the equalizers exceed the combined loss of the crosstalk paths at any frequency in the band, high-level oscillations will result. This is, of course, most likely to happen at the higher frequencies, where the equalizer gain must be high and crosstalk loss is low. Transmitting two directions in separate units within the same cable helps, but is not always practical. Thus, maximum equalizer spacings have been established for the wire gauges being used in Picturephone loops (see table on page 172), limiting the gains to values unlikely to cause high-level oscillation.

Actually, two different versions of the equalizer are required to satisfy the transmission requirements of Picturephone service (see illustration on page 172). One version is adjustable to match the characteristics of sections of cable; the other has fixed gain and frequency characteristics to match runs of wire within central offices. Build-out networks and test access points (not shown in the illustration) are necessary to align the system. The equalizers located in manholes are powered in series over the same pairs used for signal transmission.

The equalizers cannot be adjusted to match the cable characteristics perfectly, nor do they track the changes in those characteristics caused by temperature variations. Each equalizer section contributes some residual distortion which, if allowed to accumulate, would be manifested as "echoes" or ghost images at the Picturephone set. The resulting deterioration of the picture depends directly on the intensity of the ghost images and the extent of their separation from the main image. As a way of measuring this kind of problem, signal distortion is translated into what is called an "echo rating," which is an overall evaluation of the transmission characteristics of a loop with equalizers added for video service.

To determine whether existing customer loops are suitable for high-frequency signal transmission, the performance of these loops with equalizers added is simulated on a computer. The simulation program decides where equalizers are needed and simulates the adjustment they would receive in the field. The resulting echo rating indicates whether the particular loop configuration is suitable for system use.

Picturephone service will first be offered in urban areas. Tests of selected loops in New York City and Pittsburgh have confirmed that existing facilities in those cities can be used for Picturephone service, as it is now planned. (A product trial between these two cities is now being run, in cooperation with the Westinghouse Electric



T. A. Sickman of Bell Laboratories tests and adjusts equalizers to be used in Picturephone loops. The equalizers are connected to a 6000-foot length of test cable to simulate a customer loop arrangement. In addition to providing gain compensation, equalizers are used to correct distortion of the video signal.

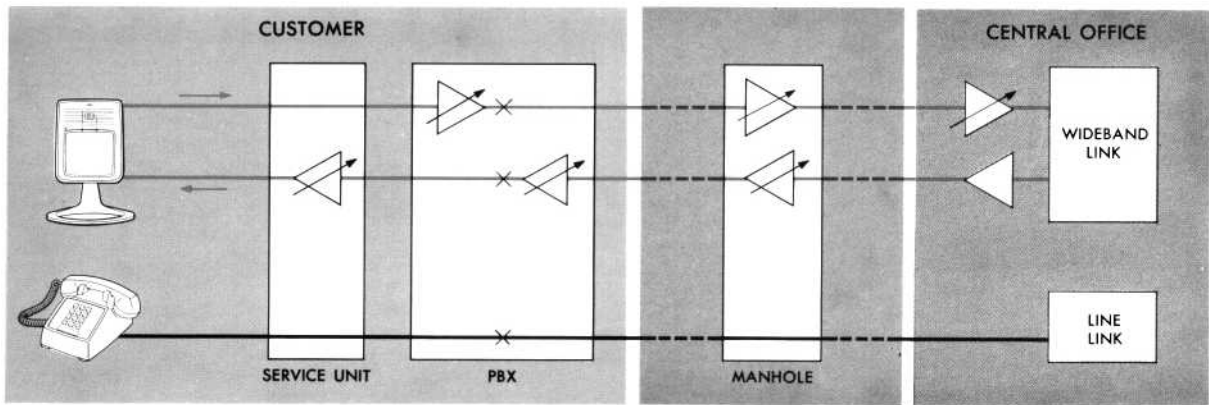

The video portion of a Picturephone loop is added in parallel to the existing telephone loop network.

Equalizers in manholes are powered in series over the same wire pairs used for signal transmission.

Corporation.) As the service is extended toward suburban areas, many additional factors will have to be considered.

Customer loops for ordinary telephone service, for example, are designed to resistance limits which insure satisfactory dialing and talking regardless of the distance between the office and the customer. This is accomplished by using a range of wire gauges (19, 22, 24, and 26 gauge) and adding inductances, called loading coils, at 6000-foot intervals on loops longer than 18,000 feet. It is common to find a combination of wire gauges and both paper pulp and plastic-insulated conductors in a single customer loop. Such an arrangement appears to be satisfactory for ini-

tial urban Picturephone service. But, as the service expands, all the various transmission irregularities at video frequencies will have to be checked carefully.

Additionally, it has always been difficult to predict the growth pattern of the lines and services for a central office area, and to predict needs along any given cable route. These uncertainties, and the fact that it is difficult to get at individual wire pairs in pulp-insulated distribution cable, have led many telephone companies to install cables with "bridged taps." That is, several "taps" are connected to the individual wire pairs at intervals along the cable as it is installed. Eventually one tap on a pair is used to connect a customer's telephone service; the unused connections are called bridged taps. Loops containing bridged taps more than 100 feet long cannot be equalized adequately for Picturephone service. Survey results show that the overall Bell System average bridged tap per main station is 2500 feet long. Thus, removing bridged taps will be a normal step in preparing loops for video transmission.

Further growth in dedicated outside plant (see *Access and Control Points for Dedicated Outside Plant*, RECORD, February 1967) and unigauge (see *Unigauge-A New Subscriber Loop System*, RECORD, September 1967) will eventually result in a plant more uniform and easier to adapt for high-frequency services. In the dedicated plant concept, pairs without long bridged taps are permanently assigned to existing and probable future customer locations. The unigauge concept makes it possible to serve customers up to almost 6 miles away from a single central office, using only 26-gauge wire and range extenders from central office to customer. These and other concepts

MAXIMUM EQUALIZER SPACING		
Gauge	Same Units (feet)	Separate Units (feet)
22	5000	8000
24	4000	7000
26	3500	6000

The maximum cable lengths shown take into account variations in cables and underground temperature. They will be used as guides for installing equalizers in loops for Picturephone service except where special circumstances, such as high impulse noise levels, necessitate closer spacing.

will be incorporated as Picturephone service grows, thus helping to assure the successful blending of old and new services and facilities.

Another consideration in designing equalizers for customer loops is the variation in transmission losses resulting from temperature changes in the cable. The temperature range for buried plant about 18 inches down is about 32 to 75 degrees F. Temperature variations of aerial plant, on the other hand, track the surrounding air temperature, and increase about 20 degrees more when there is direct warming by the sun. Today, the trend is toward placing all new plant underground wherever possible. By 1975, practically all new residential distribution cable installed by the Bell System will be out of sight. This trend will help reduce both seasonal and day-to-day temperature changes in the loop plant, and thus promote more stable electrical performance.

As Picturephone service spreads into the suburban and rural areas, there may be a problem with radio-frequency interference, since much of the loop plant in these areas includes aerial cable. Unshielded aerial drop wires act as antennas for radio waves impinging upon them, and the 1-MHz range of the video signal overlaps the 0.5-to-1.6-MHz range of powerful commercial broadcast transmitters. Shielded drop wires and access terminals, short equalizer spacing, and low-pass filters can all be used to combat interference. The specific approaches used will depend on each particular situation. Studies are under way to improve our understanding of the interference to be expected in the frequency range of Picturephone signals.

Like all significant changes in the customer loop plant, the introduction of Picturephone service will require revisions to current planning, engineering, installation, and maintenance methods. Techniques of dealing with interference and the other problems will evolve as they have in the past. The administration of Picturephone loops also will be more involved. Since these loops contain equalizers, they cannot be rearranged as simply as conventional telephone pairs, but will have to be segregated in much the same way that special service loops are today.

Further in the future, improved new cable designs, which have been under development for voice use, will also help us do a better job of meeting the combined needs of voice and video transmission. Just as the present ways of engineering and constructing loops have grown out of successive improvements, so too will the Picturephone loop network evolve as we learn and progress from each successive experience.

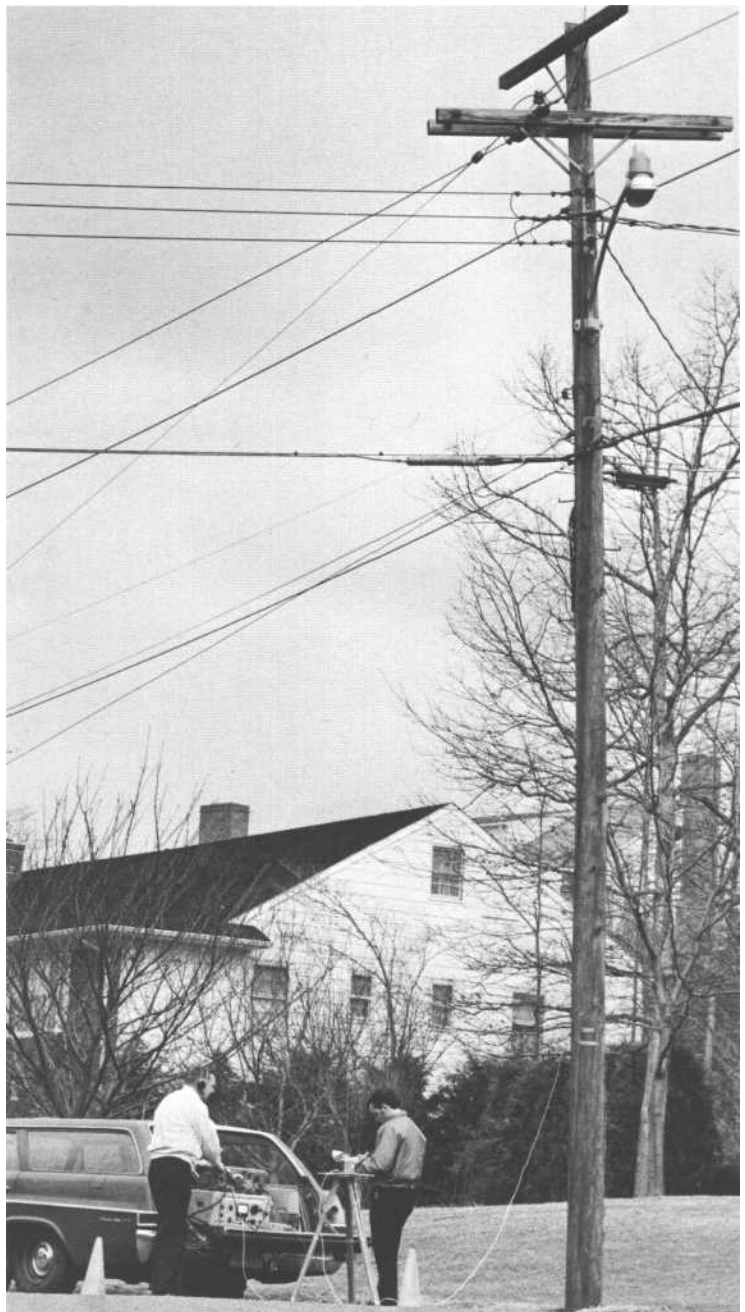

M. F. Veverka and E. W. Banz, Jr., both of Bell Laboratories, measure electric field strength and the associated interference on telephone lines to help determine the need to prevent radio frequency interference with the 1-MHz video signal.

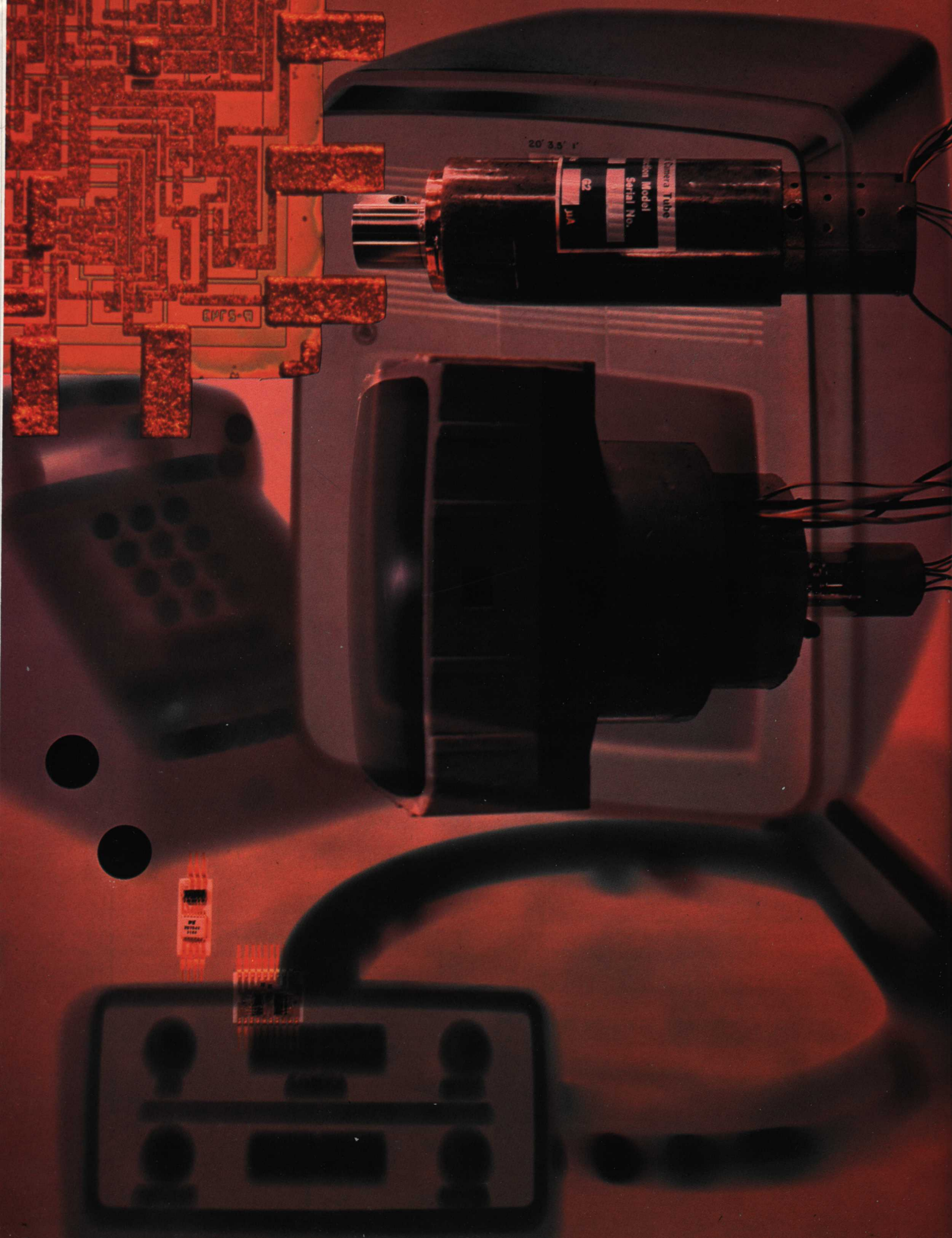

20' 3.5' r

Camera Tube
Model
Serial No.
µA

6PFS-9

6PFS-9

6PFS-9

The Picturephone system is possible in an economical form because of recent developments in electronic components technology. How recent is best illustrated by the integrated circuit devices in the display unit, as well as by its picture and camera tubes.

Devices- The Hardware of Progress

S. O. Ekstrand

ANYONE SCANNING a list of the electronic devices used in the PICTUREPHONE® system will gain insight into the meaning of technological evolution. On this list are devices that would have been impossible to produce only a few years ago—devices, for example, that draw heavily on recent silicon and thin-film technology. This article will limit itself to describing eight devices that most clearly embody the latest advances in the technology of electronic components: the picture tube, the camera tube, and six integrated-circuit devices. All eight were expressly designed for the Picturephone display unit.

The picture tube is an electrostatically focused cathode-ray tube with magnetic deflection. Of the eight devices, it is the only one the customer will see and, inevitably, it will remind him of his home television set. However, there are significant differences—most of which add up to greater safety, reliability, and economy of installation.

For example, the tube's deflection yoke is positioned during manufacture and then permanently fastened in a polyurethane encapsulation. In addition, frame-centering projections are molded into the encapsulation so that the tube can be easily centered in its enclosure. These and other features make installation a relatively simple job—and a safe one, since the rock-hard polyurethane also serves as a protective shield. A further margin of safety is supplied by a glass panel that is bonded to the face of the tube. This panel serves a double purpose: Its surface is lightly etched to reduce glare in brightly lighted rooms.

Like all telephone devices, the display tube had to be designed for long life. Its envelope is made of a special glass that is highly resistant to the discoloration caused by electron bombardment, and all of its electrodes are designed to meet exacting electrical tolerances. A case in point is the cutoff voltage required for grid number one.

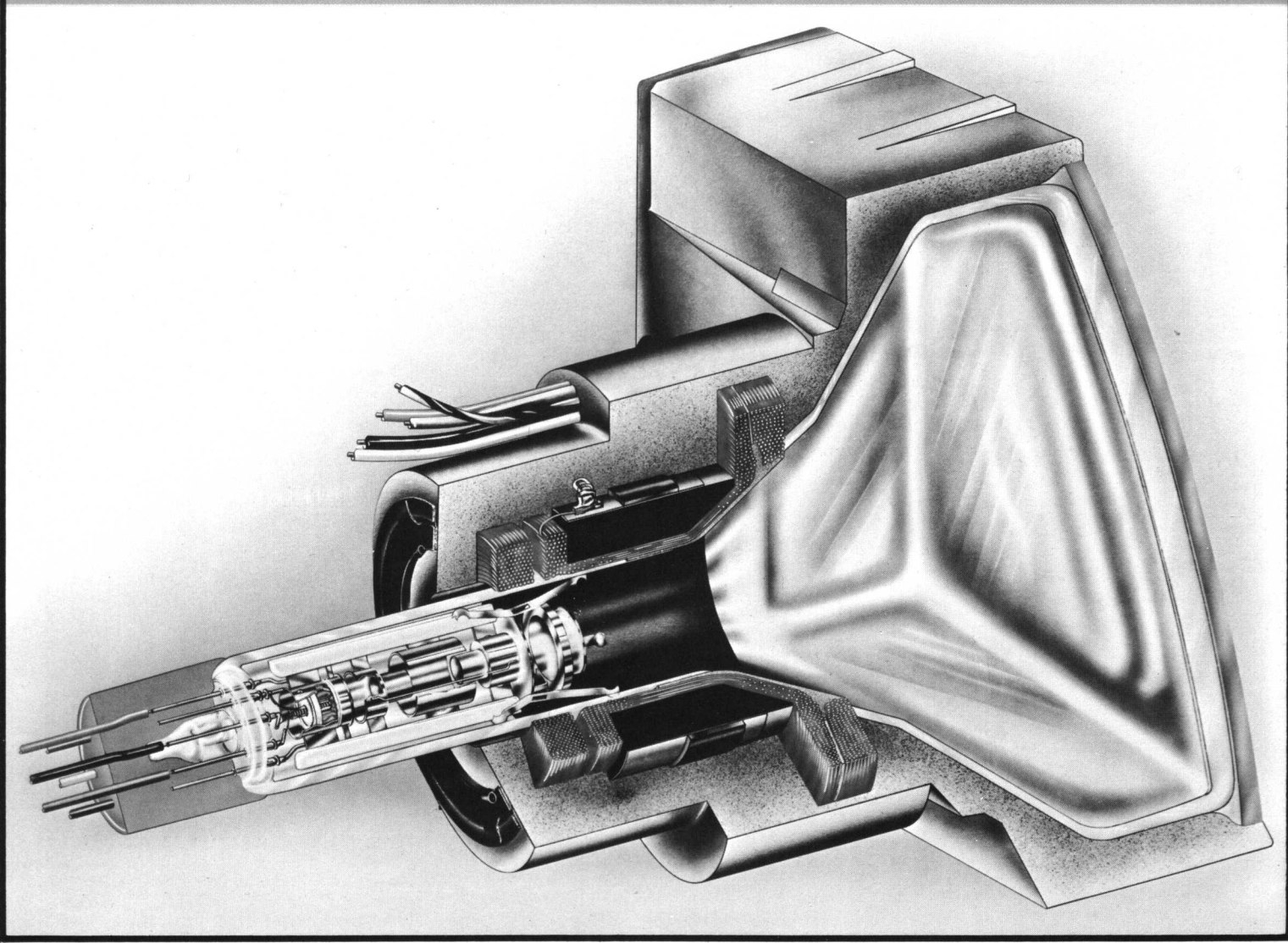
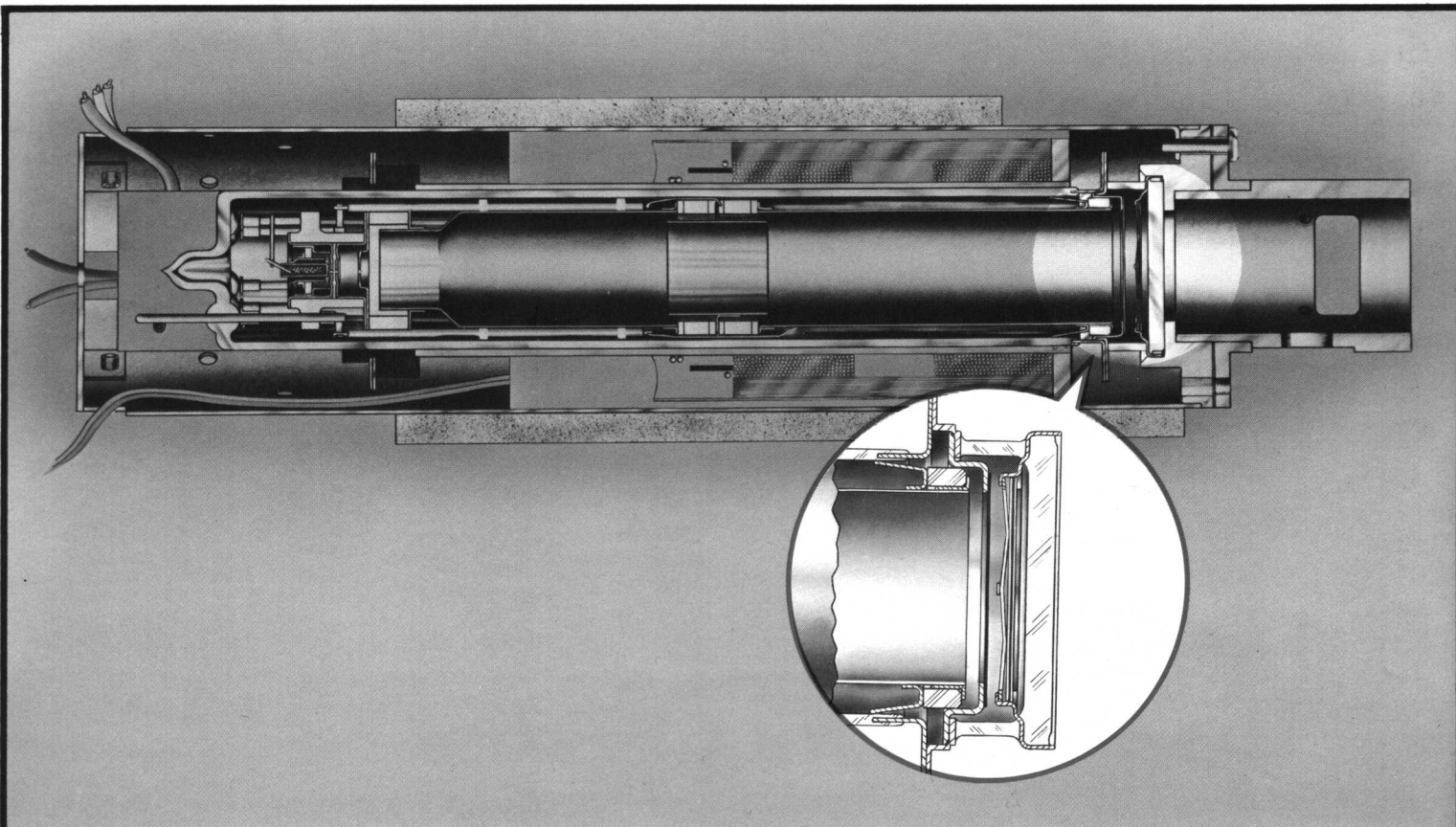

This voltage is the minimum needed to stop the electron-beam flow entirely. In the drive circuit of an average cathode ray tube, the cutoff voltage would have to have an allowable range of 30 volts or more. In the Picturephone set, however, the cutoff voltage needs a range of only 15 volts, which permits more economical circuitry. What makes this reduced range possible is precise control of spacings and grid aperture sizes during manufacture.

In life tests, the tubes have been living up to their design objectives and continue to deliver high and constant output. They show negligible loss in brightness after eight to ten thousand hours of continuous operation, and there have been no indications of discolored glass.

The camera tube is even more a product of modern technology than the picture tube. (See *A "Solid-State" Electron Tube for the PICTUREPHONE Set*, RECORD, June 1967). This unusual tube uses a target consisting of an array of more than half a million silicon diodes in an area approximately one-half inch on a side. The diodes are reverse biased and scanned by an electron beam. A thin resistive film over the target's face prevents the beam from charging the silicon dioxide surface to the point where it would reflect the beam.

One of the things that can affect the tube's

Cutaway view of the Picturephone set's camera tube (top). The silicon target is immediately behind the lens at the right. Thin enough to be translucent, the target has over half a million silicon diodes in an area about the size of a nickel. Like the display tube, the camera tube uses electrostatic focusing and magnetic deflection. The entire tube is shielded by high-permeability magnetic material. The insert below the camera tube shows the "mesh" electrode, which forms a uniform field between itself and the target.

(Bottom) The display tube is essentially a "plug-in" device and requires no adjustments during installation. The deflection yoke is positioned during manufacture and permanently set in place when the tube is encased in polyurethane plastic (shaded area). Projections molded into the plastic make it easy to center the tube in the display set.

performance adversely is the target's "dark current"-that is, the leakage current generated by the diodes even in total darkness. Excessive dark current limits the maximum contrast of the picture. The problem is created by two kinds of dark current, known as "surface generated" and "bulk generated." The surface-generated dark current is due to surface-state energy levels that exist at the silicon dioxide interface. Although these energy levels arise from a number of different causes, they can be collectively measured and considered as a single phenomenon. At one time, the surface-state energy levels were a major source of dark current, but improved processing of the silicon target has virtually eliminated this problem. Similarly, bulk-generated dark currents-which are due to the activity of charge carriers within the bulk of the silicon-are now held to a minimum by proper processing of the silicon.

The structure of the electron gun also plays a part in holding down dark current: The gun's elements are arranged so that all light from the cathode and heater is barred from the target, and dark current due to this light is minimized.

Mechanical strength and alignment of the newer tubes have also been much improved. The gun's electrodes and ceramic spacers are brazed together by a pass through a furnace. And to ensure accurate alignment of the beam-stripping electrode (which trims the beam's diameter to 0.003 inch), laser technology is called upon: The electron-gun structure is completely assembled and then a pulsed ruby laser is used to drill a 0.003-inch hole through the beam-stripping electrode. The resulting alignment is precise enough to guarantee maximum beam transmission.

The mounting of the silicon target has a minimum number of parts, so that manufacture is simplified and capacitive coupling between the target and other elements is minimized. In addition, the external terminal of the "mesh" electrode (which forms a uniform field between itself and the target) has been placed close enough to the target area to allow a common ground reference for both the mesh and the target. This arrangement eliminates ground loops between these elements and minimizes noise from induced currents.

The camera tube is supplied ready for use and comes with its magnetic deflection

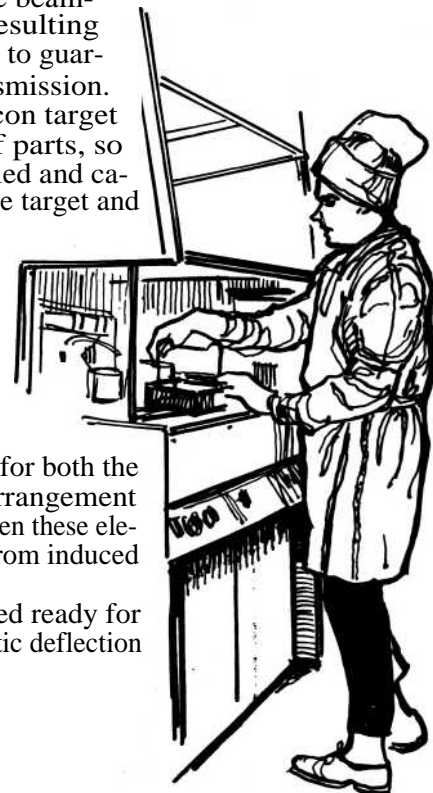

coils prepositioned. The electron beam is magnetically aligned within the gun during manufacture, and the tube is enclosed in a high-permeability magnetic shield. All of this eliminates the need for any adjustments after manufacture, which means that the tube is essentially a plug-in device.

The six integrated circuit devices that control the camera tube are the products of the same up-to-date technologies. The devices are: a voltage regulator, a linear video gate, a video gate logic circuit, a synchronizing clock oscillator, a synchronizing tip generator, and a synchronizing clock logic system.

The voltage regulator maintains a critical supply voltage for the sync clock oscillator and the horizontal and vertical sweep generators for the camera tube. It is designed to supply 12 volts (\pm one percent) with a load carrying from -10 to -30 milliamperes and line voltage varying from 16 to 24 volts over a temperature range of 0 to 60 degrees C. Physically, the regulator consists of three silicon chips—a junction field-effect transistor, a voltage reference diode, and a silicon monolithic integrated circuit. All three are mounted in an eight-lead transistor type encapsulation that has adequate power dissipation capabilities.

The sync clock system supplies all of the timing signals for the Picturephone set's camera. These signals control the horizontal and vertical sweeps, camera blanking, gating for the automatic gain control and video clamping, and the formation of the sync output signal. The precise time constants needed to maintain precision are achieved with thin-film capacitors and resistors. Amplification and buffering functions are handled by a separate silicon monolithic integrated circuit chip. A similar combination of thin-film

and silicon integrated circuits is used for the sync tip generator. This circuit provides an accurately timed pulse that is combined in the sync clock logic circuitry to form the sync output signal.

Two "count-by-16" circuit chips plus a "miscellaneous logic" chip supply the necessary logic for converting the output of the sync clock oscillator and the sync tip generator into the required six timing signals. The count-by-

16 circuits include a complete four-stage binary counter and use 72 transistors and 111 resistors to form 40 logic gates. These gates are designed to assure reliable low-power operation even with considerable variation in component parameters. Their high tolerance for variation makes possible high manufacturing yields—another contribution to economy.

The count-by-16 circuits are used to divide the sync clock oscillator's basic frequency of 16.26 kHz to get a vertical sweep frequency of 60 Hz and ensure precise field interlacing. A similar, "miscellaneous logic" chip supplies 46 logic gates of the kind used in the count-by-16 circuits. Made up of 74 transistors and 116 resistors, the chip handles all the gating for the timing functions that control the camera tube. This circuit has the most logic gates per chip and the highest packing density of any integrated circuit presently being supplied by the Western Electric Company.

The complete video gate is made up of two silicon monolithic integrated circuits. One, a linear video gate, is a single-pole, double-throw switch for coupling the desired video signal through to the output with negligible loss, while providing almost total isolation from undesired signals. It is used to achieve the **MONITOR** feature as well as some other features. The second of the two monolithic circuits is a video-gate logic circuit that drives the appropriate indicator lamp on the control unit and also supplies the control signals for the linear video gate circuit.

To produce these devices in a reasonable amount of time without sacrificing reliability or economy, Bell Labs device designers had to work very closely with designers of the Picturephone set and with the Western Electric Company engineers who will eventually be responsible for manufacturing them. To smooth the transition from design to manufacture, a joint development and manufacturing facility was installed at the Bell Laboratories location at the Western Electric Plant in Reading, Pennsylvania. Planned by a team of engineers from Bell Labs and Western Electric, this installation has facilities for developing all the devices described in this article. All planning was done with an eye toward early pilot manufacture.

The fabrication area is a series of clean rooms specifically designed to satisfy the stringent requirements of semiconductor and electron tube manufacture. The area is supplied with filtered and air-conditioned air, which is monitored to ensure a dust count no greater than 500 particles per cubic foot. The flow is pseudolaminar, with



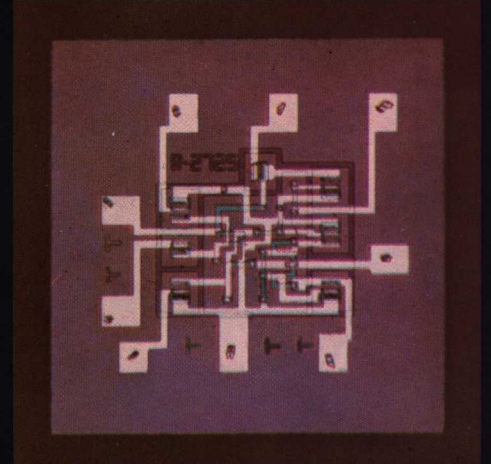
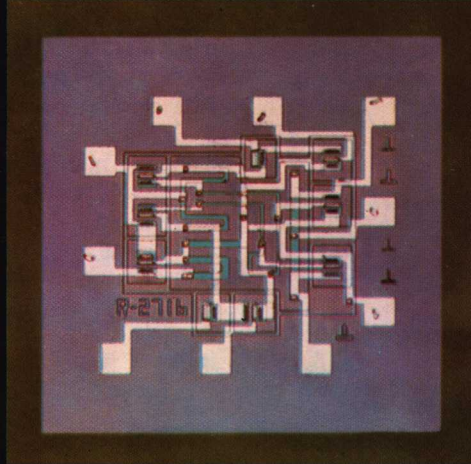
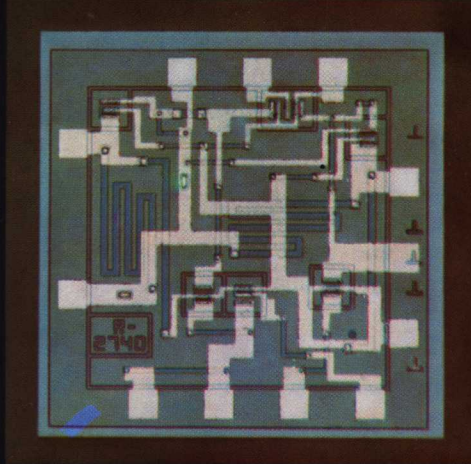
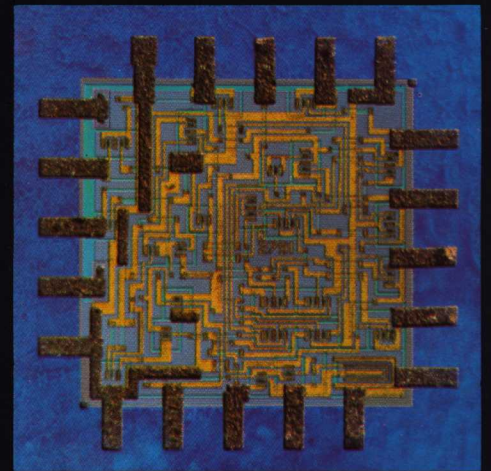
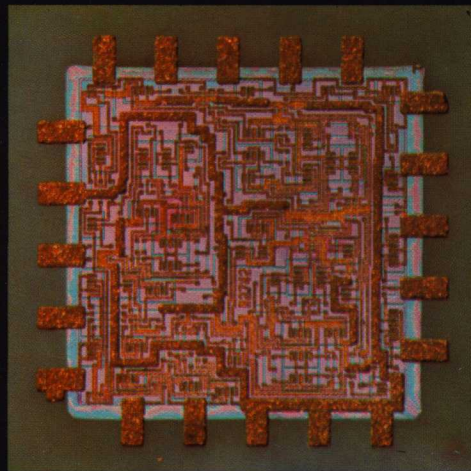
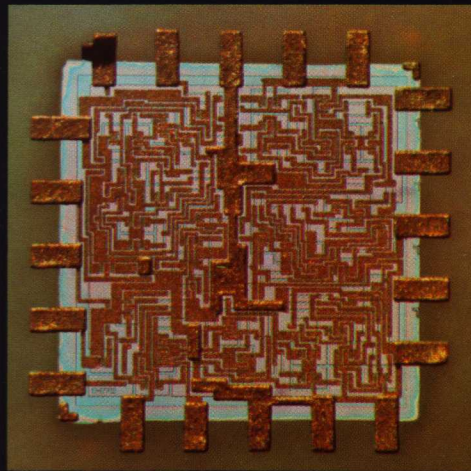

Photomicrographs of the "chips" used in the display unit's six integrated circuit devices. The largest is only about one sixteenth of an inch square. The chips in the top row are: count-by-16 logic (left), miscellaneous logic (center), and video gate logic (right). The center row includes the linear video gate (left), sync clock oscillator (center), and sync tip generator (right). The chip to the lower right is used in the 12-volt voltage regulator. Two of the count-by-16 logic chips are combined with a miscellaneous logic chip to make up the complete sync clock logic system. With its 74 transistors and 116 resistors, the miscellaneous logic chip has the highest packing density of any of the integrated circuit chips presently being supplied by the Western Electric Company.

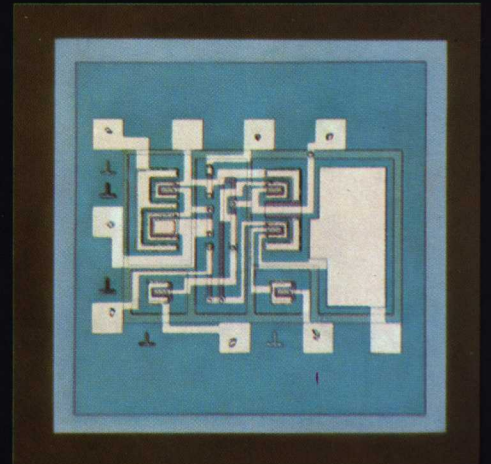

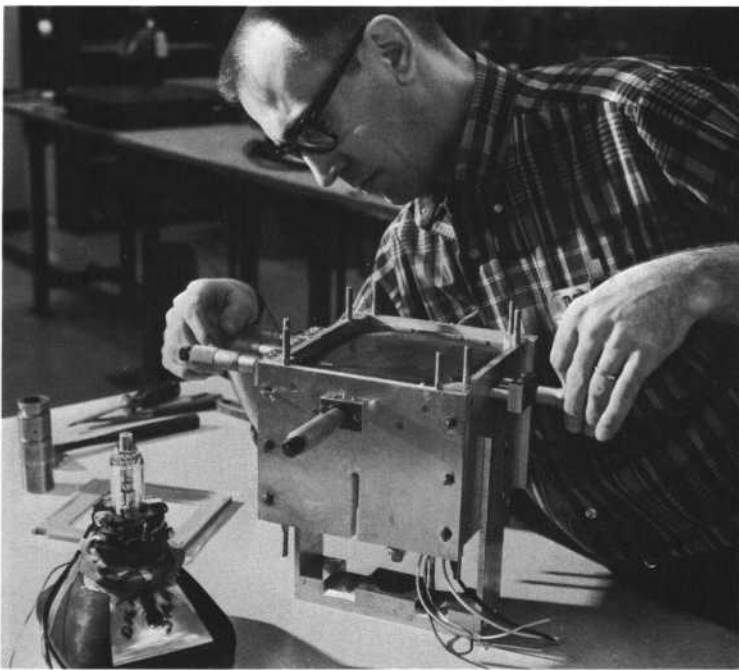

Glenn Hill of the Western Electric Company makes final micrometer adjustments of an encapsulation mold for the Picture-phone display tube. The adjustments accurately position the tube before polyurethane is poured in. Centering projections molded into the polyurethane facilitate installation of the tube.



air entering through the ceiling and exhausting through specially constructed walls. Laminar-flow clean hoods are installed at work stations where the most critical operations are performed. The dust count at these stations is never more than 10 particles per cubic foot in normal use.

The installation also has separate vestibules in which shoes are machine brushed and special clothes donned. Particular attention was given to the construction of the ceiling and floors so as to permit easy maintenance. To ensure special cleanliness in critical areas such as the photo-resist rooms, these rooms are held at a higher pressure than others. Services such as gas and water also receive special treatment: Before entering the rooms, the gases are filtered and dried, and the water (deionized) is double filtered.

In addition to technical people from Western Electric and Bell Labs, the installation has many Western Electric operating personnel. Their presence affords them early exposure to the new technologies, which is important, since they will later serve as the nucleus of the manufacturing force. The advantages of this arrangement are two-fold: The Western people have a chance to prepare for manufacture at an early stage, and the Bell Labs people have a chance to benefit from their advice. The result is that many of the development tools, fixtures, and machines can be easily incorporated into future manufacturing facilities.

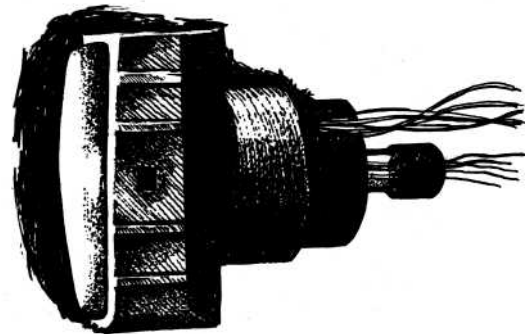

A pulsed ruby laser inside this "black box" ensures precise alignment of the camera tube's beam-stripper—the electrode that trims the electron beam to a diameter of 0.003 inch. After the beam stripper is aligned with other electrodes, the laser bores a 0.003-inch hole through it. Bob Sell, on assignment to the Reading Laboratory from the Western Electric Company, is shown loading an electron-gun structure into the unit. He will use the television monitor to aim the beam.

Planning maintenance procedures for Picturephone service requires a considerable degree of foresight. Practices suitable for only a few customers initially will still have to be viable in the future when video service is as widespread as telephone service is today.

Maintenance- Keeping the System in Trim

A. E. Spencer

TODAY, as PICTUREPHONE® service makes its first appearance, we are relatively unencumbered with previous maintenance procedures. This gives us a unique opportunity to plan overall maintenance arrangements before the service is introduced—although, obviously, new arrangements should fit in with existing ones as much as possible.

With this freedom, however, comes the challenge to plan ahead so that maintenance arrangements initially required for only a relatively few customers in one or two cities will still be valid or adaptable when Picturephone service is as widely used as the telephone is today. This article describes how the Bell system is preparing to meet the challenge. Of necessity, our present emphasis is on planning rather than on accomplishment. Much of the circuit and equipment design is still in progress, and it is impossible to work out all the details of a maintenance plan until the detailed nature of equipment and circuitry is known and some operating experience is gained.

The starting point for planning maintenance

arrangements for new equipment is to consider present practice. Maintaining the telephone plant today is a complex job that requires the efforts of a large number of the Bell System's employees. Their efforts are directed at detecting, locating, and repairing troubles in three general areas: (1) loops and customer equipment, including PBX's, (2) interoffice trunks, and (3) switching offices. For performing these tasks, maintenance personnel have a variety of test equipment at their disposal, ranging from simple meters to highly sophisticated equipment capable of making many complex tests automatically.

Yet, in spite of all this test equipment, our ability to detect and locate troubles is not always satisfactory. All too often, we are not aware of trouble until the customer reports it. And all too often, a repairman must be sent into the field to locate that trouble. He, in turn, may have to work with another man in the central office—all of which is time-consuming and expensive.

In planning maintenance for the Picturephone system, we have tried to improve our ability to

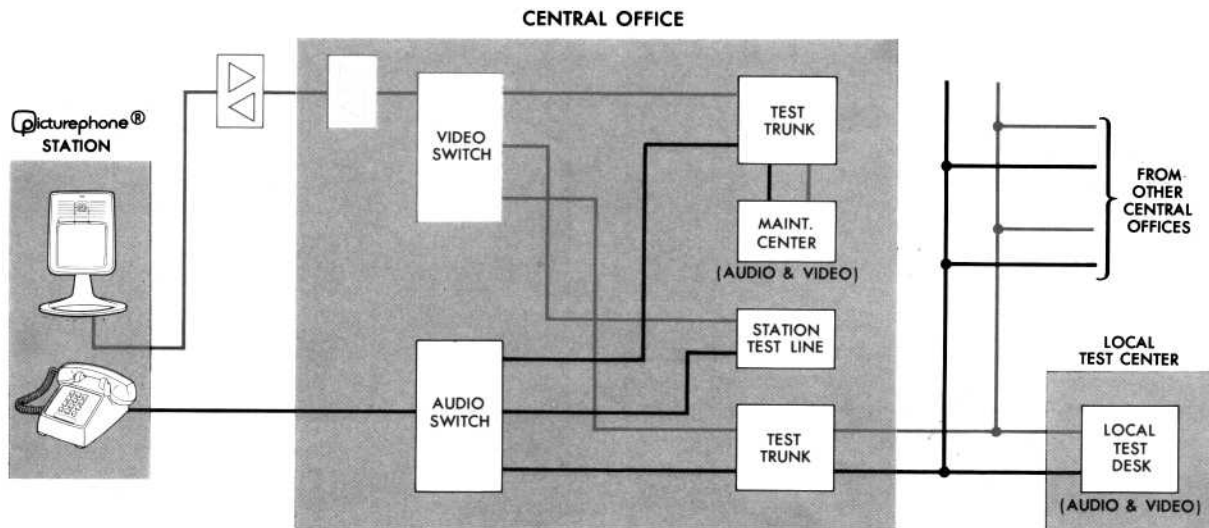

Plans for station and loop testing include a station test line that will permit convenient testing of newly installed Picturephone sets and a local

test center (to the right, below) that will be able to perform a number of tests on all equalizers between Picturephone sets and the central office.

detect, locate, and repair troubles while keeping overall costs down. Similarly, we have tried to integrate maintenance for the Picturephone system with existing telephone maintenance practices. For the voice channels of the Picturephone system (see the diagram at top of this page), the station and loop testing arrangements are identical to those being used today for conventional telephone service. For the video channels, the arrangements are similar but are considerably improved in that tests made at maintenance centers and local test desks are expected to be much more effective in locating troubles.

In new installations, an installer will be able to make a number of simple but valuable tests with a "test line" (shown to the right of the video switch in the block diagram). After completing an installation, he can dial the video prefix (#), followed by a three-digit test access code and the last four digits of the line he has installed. The central office will then connect the new line to the test line, and the installer will hear a tone. Now, if he flashes his switchhook and hangs up, the central office will transmit the special Picturephone ringing signal to test this aspect of the new set's operation. When the installer answers, he will be able to make a number of other tests, including some relatively simple video tests.

If the tests show that performance is not satisfactory, or if trouble develops later, it may be necessary to test the line from the new wideband local test desk. Here is where maintenance for

Picturephone service is expected to be significantly better than present telephone maintenance. The tester can cause signals to be looped back at the Picturephone set and at all intermediate equalizers in the loop. Both ac and dc tests can be made of the equalizers. Since the equalizers are powered over the loop and draw relatively fixed currents, simple voltage and current measurements can be made to locate open or short circuits on the line within an equalizer section. It will also be possible to send a low-frequency signal out over the video portion of the loop to control an equalizer in such a way that the signal will be returned from it if the equalizer is working. It will then be possible to loop similar signals back through the second and third equalizers, if there are any. This procedure should make it possible to locate faulty equalizers before dispatching a repairman.

Following successful completion of these simple tests, it will be possible to transmit a video test pattern to the video set. If the set is on hook, the video signal will be returned to the test position through the loop-back feature at the station. Measurements of received signal level, quality, and other factors will then permit further trouble analysis.

The arrangements for interoffice trunks are different. (See the diagram on page 185.) Since the initial number of interoffice Picturephone trunks will probably be quite low, the trunk test facilities will be manual at first, and not automatic. For very small offices, all trunk mainte-

nance may be done with maintenance center facilities, and no wideband trunk test position should be required. As service grows, however, a wideband trunk test position may be installed, and, ultimately, automatic test facilities for video trunks will probably be developed to complement those now being designed for audio trunks. The test facilities will have appropriate access to the central office switching network so that all parts of tandem and intertoll trunks may be tested.

In general, the tests that can be made on trunks that carry analog signals will be similar to the tests that can be made on loops. Although the details of equalizer designs will be different, there will be similar facilities for locating troubles within any section between two equalizers.

In No. 5 crossbar, conventional jack access to all audio trunk pairs will be provided for testing. Besides allowing a testman to make normal transmission tests, these jacks will give him direct access to signaling leads as well as a way of making the facility busy simply by inserting a suitable plug. Insertion of the plug will also make the corresponding video facility busy. With ESS, the more convenient switched access, rather than jack access, will be provided to test both audio and video trunks.

Today, we have a series of test trunk terminations in distant offices that can be reached on a dial-up basis for conventional audio trunk testing. For Picturephone service, we will have an equivalent series for video trunk testing. For example, one type of test trunk will terminate the receive direction of the video facility in a matching impedance and will generate a short burst of 1-kHz tone over the transmit direction as well as over the audio channel. After this, the transmit direction of both the video and audio facilities will again be terminated in a matching impedance.

Another type of test trunk will have facilities for Picturephone service and two-man testing between test-boards using a wide variety of test equipment. A third type of trunk will terminate

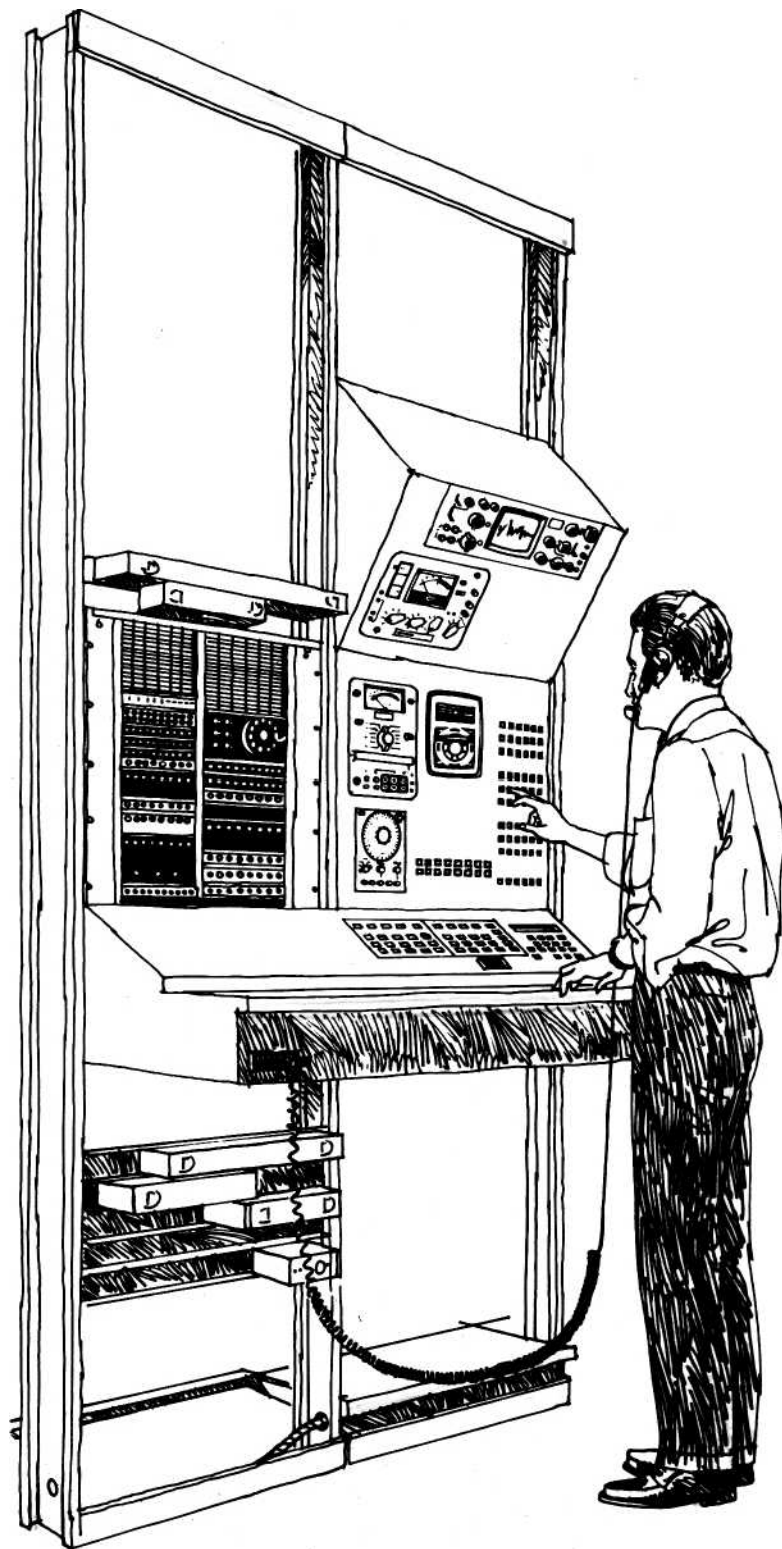

The new wideband trunk test positions now being planned for the Picturephone system may look like this artist's rendering. Located at central offices, the trunk-test positions will be equipped with several test instruments new to telephone maintenance. Among these are wideband oscilloscopes for analyzing video signals and "echo-rating" test sets for measuring echo in trunks.

the receive direction and supply a steady source of 1-kHz tone over both the video and audio facilities in the transmit direction. After about 20 seconds, the test tone will be removed, and the receive side of the trunk will be connected to the transmit side. Still another type of trunk will permit signaling tests by cycling the trunk through on-hook and off-hook conditions.

A major difference between trunk and loop testing is that trunk testing arrangements will have to include tests of digital facilities, whereas loop testing arrangements will not. Codecs (devices for coding and decoding video signals in digital form) will be used only with trunks, and provisions will have to be made for testing them. In general, the basic test of a codec will involve a loop-back in which a test signal is first coded in the coder and then connected back to the decoder. At the decoder, the test signal will be decoded for comparison with the input signal. For such testing, the codec will most likely be controlled over a direct path from the maintenance center and the wideband trunk test position-at least, initially. As the use of digital facilities increases, this procedure will probably change.

Maintenance of the switching equipment itself will generally follow procedures already in use. For example, in the case of No. 5 crossbar, trouble record indications will be received from alarms and trouble cards just as they are today. In the case of No. 1 ESS, of course, the maintenance control console and maintenance teletypewriter will be the focus of a testman's activities. In both cases, he will follow normal routines to locate and repair the trouble.

As a trouble detection technique, not only in switching equipment but in transmission facilities as well, an ac continuity test of the video path will be made prior to every call. This test will not only help in the detection and location of troubles; but will also improve the level of service received by customers. Implementing the overall maintenance plans



Artist's rendering of what a local test desk for the Picturephone system might look like. Such "desks will be installed in centralized locations to test Picturephone lines throughout a city.

will require some new kinds of test equipment, although much of the equipment in use today will still be usable. For example, a low-frequency transmission measuring set will give a rough idea of how a video facility is performing. But it will be necessary to go beyond this and create a video-frequency transmission measuring set. Similarly, wideband versions of such instruments as noise-measuring sets and variable frequency oscillators will be needed. Most of these instruments are similar in kind to voice-frequency equipment; however, some new instruments will be peculiar to the Picturephone system. These include a video-image generator to serve as a source of video test signals; a video monitor for observing signals; an oscilloscope for observing signal waveforms; and a delay measuring set, or "echo-rating" set as it is sometimes called.

"Echo-rating" is a new concept. It is determined for a given facility by first measuring the power in any echoes reflected from impedance discontinuities in that facility. The powers of the various echoes are then weighted, with the greatest weight being assigned to the echoes that are most delayed from the desired signal. The ratio of the sum of weighted echo powers to the power of the desired signal is called the echo rating. The echo-rating test set will perform the rather complex functions of measuring, comparing, and weighting echoes, and will then display the result. After measuring individual sections of an overall facility or connection with an echo-rating set, it will be relatively simple to determine which sections are the source of excessive echo signals.

The echo-rating test set will be extremely useful in providing high-quality pictures. Along with all the other test equipment mentioned, it is part of an overall plan to assure customers of trouble-free service as well.

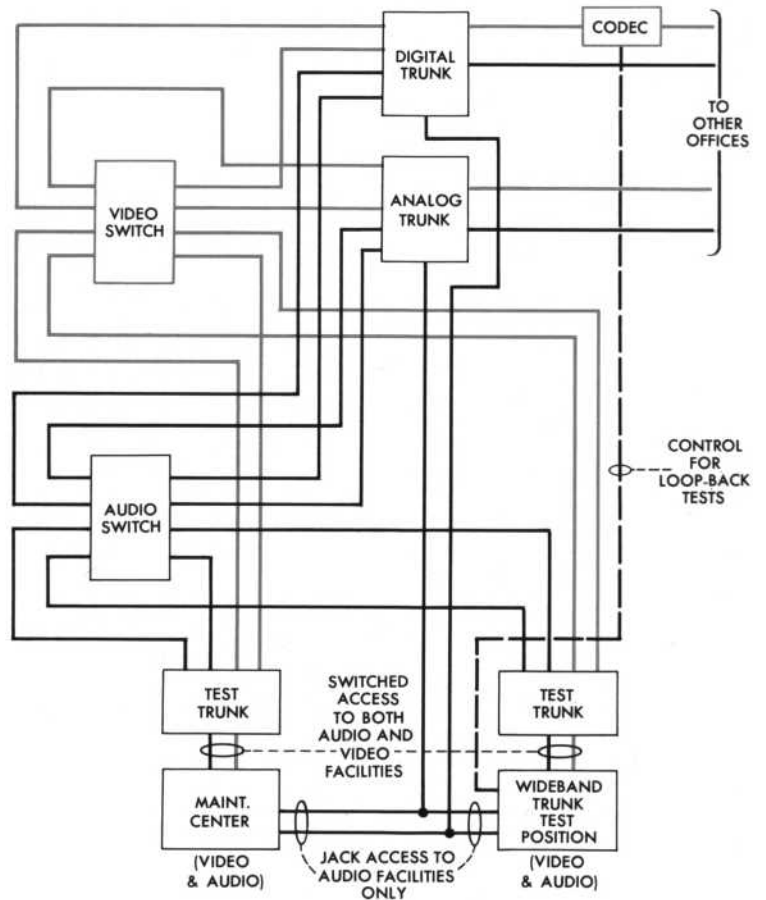

Block diagram of the maintenance arrangements planned for interoffice trunks in the No. 5 crossbar system. Audio facilities are shown in black, and video facilities are shown in gray. Since tandem and intertoll trunks terminate on both sides of the central office switching network (indicated here by the video and audio switches), test facilities must also have similar dual access. Maintenance arrangements will include equipment for testing wideband video signals and digital facilities such as the codecs that code (and decode) video signals into digital form.

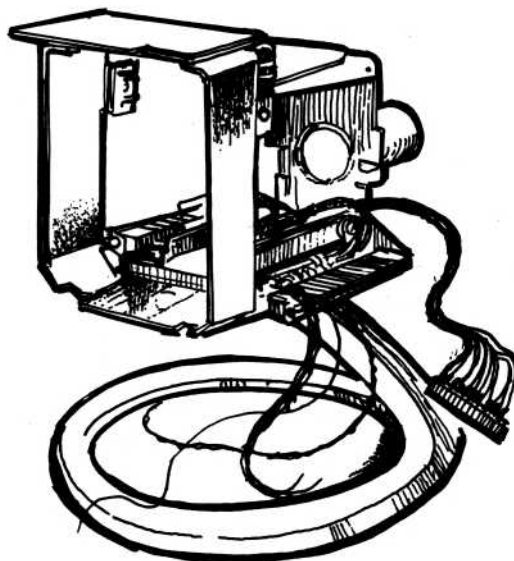

Tomorrow

THIS SPECIAL ISSUE of the Bell Laboratories RECORD shows what we are doing to provide PICTUREPHONE® service. As the service becomes available to more and more people, new features will be developed to increase its versatility. For example, we are working on a method that will allow businessmen to see and read high-resolution images of drawings, sales literature, reports, and the like. By using a slow-scan mode, which permits high resolution with no increase in bandwidth (but at the sacrifice of being able to follow rapid motion), such graphics service can be provided over the Picturephone network. Hard copy printout of picture images could be an added feature in such a service.

A way to allow people to hold conferences via three or more Picturephone sets is another essential need for business customers. And here too, work is in progress to add such a conferencing feature at the earliest practicable time. A voice-operated Picturephone conference system is now being evaluated in the laboratory. The system automatically distributes the Picturephone signal from the person speaking to all other listeners; the speaker sees the person who spoke last. Although the system is intended primarily for face-to-face conferencing, it would not be limited to this use. It could be used for management presentations that include charts and graphs, for example, or for product or other pictorial displays. Another possibility is that information generated by a computer might be displayed on the sets of all conferees. In this case, each conferee could in-

teract with the computer through his TOUCH-TONE® dial.

As you have seen in this issue, a computer display capability has already been incorporated into Picturephone service, and this capability is being field-tested in the product trial with Westinghouse Electric Corporation. Some future uses of the Picturephone set as a display device may well include interactive computer graphics using a light-pen or special keyboard.

Many of the features mentioned in this issue are being considered with a view toward improving the utility of Picturephone service for business use. Picturephone services for other uses are being considered as well. For example, we'll be looking at special Picturephone sets for specific applications. The present Mod II set, designed primarily for desk-top application, will ultimately be joined by other models, such as wall models for residential use. And it is not difficult to foresee the eventual growth of booth service.

Color Picturephone service is an obvious sequel to our present development and hopefully compatible with it. Broadcast color television suggests a general pattern for a system of color Picturephone. However, the camera as used in color television today does not seem to be adaptable for Picturephone. A Picturephone camera (1) must be able to operate satisfactorily under light of widely varying intensity and spectral content, (2) should require little or no adjustment by the customer, (3) should maintain its standards without service adjustments for periods of many years,

and (4) must especially give a good rendition of facial skin tones. For these reasons, research and exploratory development at Bell Laboratories are now concentrating on color camera systems that are simple, stable, and will work reliably in the home or office environment.

Color perception by human beings has many subjective characteristics. The colors we think we see are often very different from the true color of light reflected by objects in all the various conditions of illumination. Fundamental research on color perception at Bell Laboratories will, we hope, yield greater basic understanding of this complex phenomenon.

Looking even further into the future, we can imagine 3-D Picturephone images, or arrangements whereby equipment could be attached to deliver a print of whatever picture is on the screen. It is easy to speculate about these and other applications, but it is not so easy to find answers to the many scientific and engineering questions they imply. We nevertheless intend to investigate all promising approaches, so that the technology will be ready whenever the needs and the economics are favorable to development.

In addition to the provision of new services we must, of course, search constantly for ways to make Picturephone service cheaper. Further exploitation of integrated circuits will doubtless contribute significantly in that direction. New cables for the loop plant will make broadband transmission easier to accomplish. Methods of "bandwidth reduction," in which only those elements of a picture are transmitted which change from frame to frame, also look promising. Such a system has been demonstrated by our research people. While the terminal equipment needed to accomplish the elimination of redundancy is, in its present form, rather complicated, we are hoping that eventually it can be made cheap enough to yield an overall savings in the cost of transmission.

The coming of the Picturephone age will represent the maturing of a 1-MHz switched network. Fortunately, as described in this issue, this network can start as an "adjunct" to the network now used for telephone services. It will use telephone loops, trunks, and switching machines with only relatively moderate changes and additions. When the day comes, however, that Picturephone represents a substantial part of our communication services, then its effect on the Bell System plant will be profound. To get from now to then is an exciting challenge to all parts of the Bell System. To meet it and succeed will require human energy, capital funds, imagination, and wisdom in abundance.

-J.P.M.

May/June 1969



Research currently in progress at Bell Laboratories will lead eventually to the development of Picturephone service in color.



A voice-operated conference system, now being developed, will increase the utility of Picturephone for business customers.

THE AUTHORS



I. Dorros

Irwin Dorros (*PICTUREPHONE*®) is Director of the Network Planning Center. His responsibilities include the systems engineering aspects of the Picturephone sys-

tem, the centralization and automation of network operations, and planning for the toll network.

Mr. Dorros joined Bell Labs in 1956. His first work was on devel-

oping various transistor circuits for the early electronic switching systems. In 1960 he became Supervisor of a group engaged in designing data communication equipment for use on ordinary telephone facilities. He was named Head of the Pulse Code Modulation Repeater Department in 1962, where his duties involved designing a transcontinental system for transmitting all kinds of information by means of streams of high-speed pulses. Mr. Dorros assumed his present post in 1966.

Mr. Dorros attended the Massachusetts Institute of Technology, where he was awarded the S.B. and S.M. degrees in electrical engineering in 1956. He received the Eng. Sc. D. (Doctor of Engineering Science) degree from Columbia University in 1962. Mr. Dorros is a member of the IEEE, Eta Kappa Nu, Tau Beta Pi, and Sigma Xi.

Claude G. Davis (*Getting the Picture*) is Director of the Telephone Laboratory at Bell Labs' Holmdel, N. J., location. His organization develops new kinds of telephone instruments for use by customers; the Mod II Picturephone set was one of its products.

Mr. Davis joined Bell Labs in 1950, and his early work concerned development of exchange and toll cable. Later he specialized in development of transmission systems and worked on Pulse Code Modulation (PCM) and Time Assignment Speech Interpolation (TASI). In 1961 he became Head of a department responsible for repeater design and data analysis in the *TELSTAR*® project, the Bell

System's experimental communications satellite program. He became Head of a department developing customer radio systems in 1962, and Head of the Subscriber Loop Systems Department in 1964. He was appointed Director of the Subscriber Systems Laboratory in 1966, and assumed his present position last year.

Born in Beech Grove, Indiana, Mr. Davis graduated from high school in Ashtabula, Ohio. He received the B.S. degree in electrical engineering from Case Institute of Technology in 1950, and the M.S. degree in math from Stevens Institute of Technology in 1960. Mr. Davis is a member of the IEEE and Eta Kappa Nu.

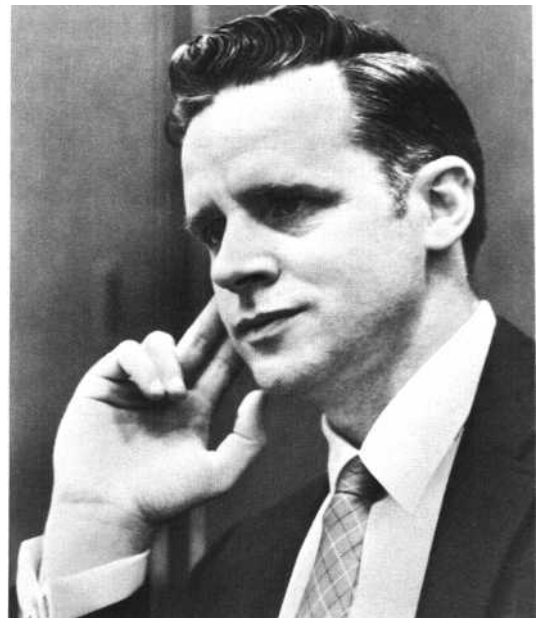

C. G. Davis

James R. Harris (co-author *Video Service for Business*) is Director of the Customer Switching Engineering Center, which is responsible for engineering studies of PBX and key telephone systems, some aspects of coin telephone service improvement, speech processing, customer switching systems, and planning of new network arrangement for government communications.

Upon joining Bell Labs in 1942 Mr. Harris developed airborne radiotelephone and navigation sets. In 1950 he joined a group developing transistors and digital transistor circuits. He joined the TRADIC (Transistor Airborne Digital Computer) project when it was formed in 1951. In 1956 Mr. Harris was appointed Head of a department concerned with data processing. Two years later he turned to exploratory work on data communications. He was appointed

Director of the Data Systems Engineering Center in 1961, and took over his present position in 1965.

Before coming to Bell Labs, Mr. Harris was with the Chesapeake and Potomac Telephone Company, first as a toll central office repairman and later in equipment engineering.

Mr. Harris received the B.S. degree in physics from the University of Richmond in 1941, and the M.E.E. degree from the Polytechnic Institute of Brooklyn in 1948. He is a member of the IEEE and a past member of the Administrative Committee of the Institute's Group on Electronic Computers. He is also a member of Phi Beta Kappa and Sigma Xi.



J. R. Harris

Robert D. Williams (co-author *Video Service for Business*) is Director of the Customer Telephone Systems Laboratory. He is responsible for development of PBX's, key telephone systems, telephone answering systems, automatic call distributors, and private telephone systems.

Mr. Williams came to Bell Labs in 1946 and joined the trial installation group, where he worked on the first installation of the No. 5 crossbar switching system. He was later concerned with developing the 740E and 756A PBX's and special systems such as recorded telephone-dictation equipment and the Civil Air Raid Warning System. He also worked on developing the No. 101 ESS, an electronic PBX. Mr. Williams became Head of the PBX Development Department in 1961, and took over his present post last year. He will be-

come Director of a new Bell Labs switching development center to be built in Denver, Colorado, where he will be responsible for the development of telephone communication facilities installed by Bell System companies on customers' premises, such as key systems and PBX's.

Mr. Williams received the B.S. degree in electrical engineering from the Case School of Applied Science in 1945. He is a member of the IEEE, Tau Beta Pi, Eta Kappa Nu, Theta Tau, and Pi Delta Epsilon.

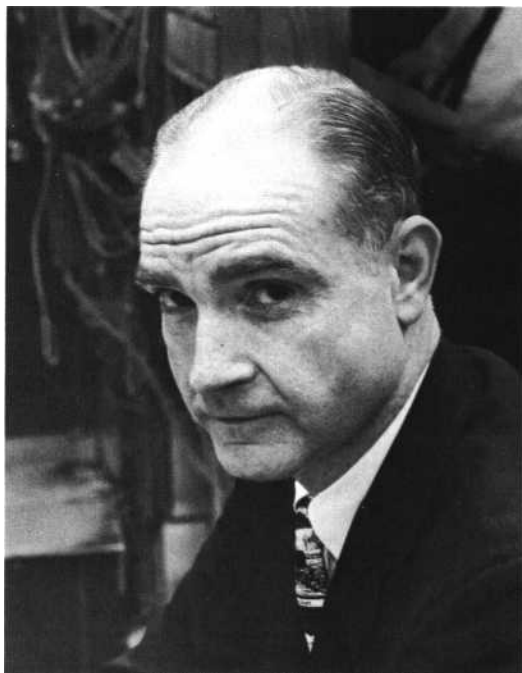

R. D. Williams



F. A. Korn

Frank A. Korn (co-author *Choosing the Route*) is Director of the Local Crossbar Switching Laboratory at Bell Labs' location in the Western Electric Company Works at Columbus, Ohio. He has been deeply involved with No. 5 crossbar switching since its inception in 1945, and his present responsibilities include all development work being done to keep this "workhorse" system up to date and extend its usefulness.

Mr. Korn has been with Bell Labs since its incorporation in 1925. He came to the Bell System in 1920 as a member of the Engineering Department of the Western Electric Company, which became BTL five years later. Ever since then his work has concerned dial switching systems. He first worked on the panel and step-by-step systems. In 1933 he joined a group responsible for fundamental planning of crossbar switching systems, including No. 1 crossbar, crossbar tandem, and No. 4 toll. During the war his efforts were diverted to military projects, including the design of airborne navigation radar and bombing systems.

For a short time after the war

Mr. Korn was responsible for exploratory development of a new dial switching system using electronic devices and intended for use in small communities. In 1947 he assumed responsibility for all circuit development of a new dial switching system-No. 5 crossbar. He was named Director of Switching Systems Development in 1952; with responsibility for development work on all local dial central offices and PBX's. When the Columbus Laboratory was organized in 1958, Mr. Korn was appointed its Director and charged with getting the new facility going. He took over his present post in 1963 when the Columbus facility was expanded. Mr. Korn was a member of the RECORD's Editorial Board from 1952 to 1959.

Active in community affairs, Mr. Korn is a member of the Columbus Area Chamber of Commerce. He is also a member of the Advisory Committee to the Columbus Area Technical School, the Advisory Board of the St. Ann's Hospital in Columbus, and the Board of Directors of the Ohio State University Research Foundation. He was named a Fellow of the IEEE last year.



Alistair E. Ritchie (co-author *Choosing the Route*) is Director of the Toll Switching Engineering Center, which is responsible for engineering studies of toll switching systems.

Mr. Ritchie joined Bell Labs in 1937 as a member of the testing laboratory in the switching development organization. In this capacity he worked on the testing program for the original No. 1 and No. 4 crossbar systems. After instructing in Bell Labs' School for War Training, Mr. Ritchie joined a group planning and teaching courses in design of switching circuits. He taught a graduate course in the principles and design of switching circuits at MIT in 1950-1951. Later he was concerned with the planning of traffic measuring equipment, and in 1953 was ap-

pointed Special Systems Engineer in charge of certain military communications and government projects. He became Systems Planning Engineer in 1955 and was engaged in studies of line concentrators and the original application of TOUCH-TONE® dialing. In 1958 he became Director of Switching Systems Engineering, where he was responsible for engineering planning of electro/mechanical switching systems, and in 1965 he assumed his present position.

Mr. Ritchie received the B.A. and M.A. degrees in physics in 1935 and 1937, respectively, from Dartmouth College. He is a senior member of the IEEE. He is co-author, with W. Keister and S. H. Washburn, of *The Design of Switching Circuits*, which is a standard text on the subject.

Bell Laboratories Record

A. E. Ritchie



D. W. Nast

David W. Nast (co-author *Transmission Across Town or Across the Country*) is Director of the Transmission Facilities Planning Center. His responsibilities include engineering planning of wire, radio, and satellite transmission facilities.

Since joining Bell Labs in 1953 Mr. Nast has specialized in systems engineering in such fields as exchange transmission, pulse transmission studies, and wide-band data transmission. He was appointed Head of the Broadband Systems Studies Department in 1964. In 1966 he became Head of the PICTUREPHONE® Engineering Department, responsible for the technical planning for Picture-phone service. He moved to his present position last year.

Mr. Nast received the B.E.E. degree from Cornell University in 1953, and the M.S. degree in electrical engineering from Newark

College of Engineering in 1957. He received the Professional Electrical Engineer's degree from Columbia in 1964. He is a member of the IEEE, Eta Kappa Nu, Phi Kappa Phi, and Tau Beta Pi.

Irwin Welber (co-author *Transmission Across Town or Across the Country*) is Director of the Overseas and Microwave Transmission Laboratory. His organization is responsible for the development of transoceanic submarine cable systems, waveguide transmission, high-frequency radio, and digital transmission on existing radio systems.

Since coming to Bell Labs in 1950, Mr. Welber has specialized in work on transmission systems.



I. Welber

His early assignments included circuit design, systems analysis, and field testing of an automatic protection system for microwave radio. He later did system analysis and design work on the Time Assignment Speech Interpolation (TASI) system. In 1960 he was appointed Head of the Ground Station Design Department, in which post he was responsible for overall systems analysis, ground communication equipment, and technical planning with foreign participants on project TELSTAR®. During the early Telstar experiments he was in charge of operations at the ground station in Andover, Maine. He moved up to his present position in 1965.

Mr. Welber received the B.S. degree in electrical engineering from Union College in 1948 and his M.E.E. from Rensselaer Polytechnic Institute in 1950. He is a member of the IEEE and Sigma Xi.

Frederick T. Andrews, Jr. (co-author *Connecting the Customer*) is Director of the Loop Systems Laboratory. He is responsible for development work on the "loops" that connect customers' telephones to their local switching offices.

Upon joining Bell Labs in 1948 Mr. Andrews worked in switching research on line concentrators and magnetic logic devices, and in 1955 he became a Supervisor in transmission systems development. Engaged in exploratory development of Pulse Code Modulation (PCM) transmission, he was responsible for planning and circuit development of portions of the terminals and line repeaters for the experimental forerunner of the first commercial PCM system. In 1958 he became Head of the Transmission Systems Engineering Department, and was responsible for transmission objectives and maintenance in the telephone and data fields. He was appointed Director of the Transmission Systems Engineering Center in 1962, and Director of the Military Communications Systems Engineering Center in 1966. He took over his present position last year.

Mr. Andrews received the B.S. degree in electrical engineering from Pennsylvania State University in 1948, was a member of the first group to enroll in Bell Laboratories' Communications Development Training Program, and has done graduate work in mathematics at Rutgers University. He is active in the IEEE as a member of the Wire Communications Committee, where he heads a task force on telephone measurement. As Vice Chairman of a Study Group of the Committee Consultatif International Telegraphique and Telephonique, he is concerned with transmission objectives and local transmission standards as related to planning the world-wide commercial telephone network.



F. T. Andrews, Jr.

Henry Z. Hardaway (co-author *Connecting the Customer*) is Director of the Exchange Plant Systems Engineering Center. He directs engineering studies of new communications cable and wire facilities, inductive interference, and outside plant maintenance. Included is the responsibility for exchange transmission requirements, station set requirements, special services requirements, and studies of the application of electronics to the exchange plant. He is also responsible for studies leading to the application of electronic computer techniques as tools for Bell System operating telephone company engineers to use in solving their engineering and planning problems in the exchange plant.

Upon joining Bell Labs in 1942 Mr. Hardaway engaged in equipment design work on various military projects, including airborne and submarine radar equipment and navigation equipment. In 1955 he became Head of a department in outside plant systems engineering. In 1963 he was appointed Director of Outside Plant Systems Engineering, directing the planning of new cable and wire facilities for the Bell System and conducting other studies. Last year he moved to his present post.

Mr. Hardaway received the B.S. degree in mechanical engineering from the State University of Iowa in 1940. He is a member of the American Society of Mechanical Engineers and the American Ordnance Association.

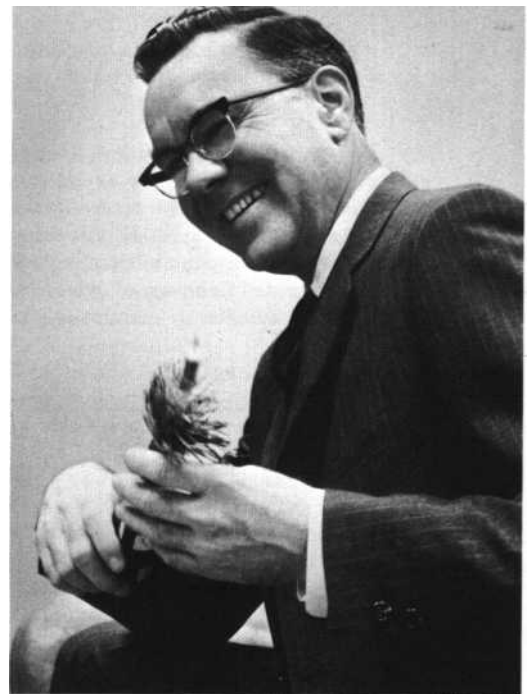

H. Z. Hardaway

Sture O. Ekstrand (*Devices-The Hardware of Progress*) is Director of the Semiconductor Device and Electron Tube Laboratory at Reading, Pennsylvania. He is responsible for development of semiconductor devices such as diodes and microwave transistors, silicon integrated circuits, and electron tubes.

After coming to Bell Labs in 1926 Mr. Ekstrand specialized in the design of mechanical structures for test fixtures and machines, as well as various kinds of telephone and recording apparatus. In 1935 he moved to the Electron Tube Laboratory, where he engaged in development of all types of electron tubes for both Bell System and military applications. In 1941 and 1942 he was a production engineer with the Western Electric Company; then he returned to BTL and supervised a group responsible for design and

processing of electron tubes. From 1945 to 1955 Mr. Ekstrand supervised electrical and mechanical development of certain types of electron tubes, and was a consultant to BTL groups doing military work. In 1955 he became Head of a department at Bell Labs' location in Allentown, Pa., where he was responsible for developing certain chemical processes, structures for semiconductor devices and electron tubes, and for applied mechanics studies. He moved to the Reading Laboratory in 1957, and became its Director in 1960.

Mr. Ekstrand received the B.S. degree in electrical engineering from Cooper Union in 1935. He is a member of AAAS and a Fellow of the IEEE. He is also a member of the Joint Electron Device Engineering Council, the Electronic Industries Association, and the United States of America Standards Institute.



S. O. Ekstrand

Albert E. Spencer, Jr. (*Maintenance-Keeping The System In Trim*) is Director of the Local Switching Engineering Center. His organization conducts studies in the local switching field and establishes objectives and requirements for local switching systems.

Mr. Spencer joined Bell Labs in 1951. After assignments in the design of circuits for transmission systems and a secure voice communication system, he supervised initial design work on the time-division switch unit for the No. 101 Electronic Switching System.

He later supervised one of several groups responsible for planning a global military communication system. In 1962 he was appointed Head of the Data Switching Engineering Department, responsible for objectives and requirements for a store-and-forward data communication system. He has held his present post since 1965.

Mr. Spencer received the B.S. degree in electrical engineering from the Drexel Institute of Technology in 1951. He is a member of the IEEE, the AAAS, Tau Beta Pi, and Eta Kappa Nu.

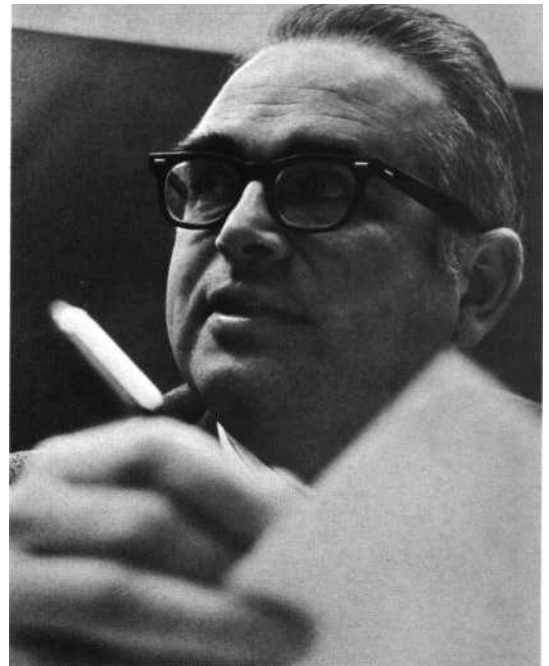

A. E. Spencer, Jr.