



This is a digital copy of a book that was preserved for generations on library shelves before it was carefully scanned by Google as part of a project to make the world's books discoverable online.

It has survived long enough for the copyright to expire and the book to enter the public domain. A public domain book is one that was never subject to copyright or whose legal copyright term has expired. Whether a book is in the public domain may vary country to country. Public domain books are our gateways to the past, representing a wealth of history, culture and knowledge that's often difficult to discover.

Marks, notations and other marginalia present in the original volume will appear in this file - a reminder of this book's long journey from the publisher to a library and finally to you.

Usage guidelines

Google is proud to partner with libraries to digitize public domain materials and make them widely accessible. Public domain books belong to the public and we are merely their custodians. Nevertheless, this work is expensive, so in order to keep providing this resource, we have taken steps to prevent abuse by commercial parties, including placing technical restrictions on automated querying.

We also ask that you:

- + *Make non-commercial use of the files* We designed Google Book Search for use by individuals, and we request that you use these files for personal, non-commercial purposes.
- + *Refrain from automated querying* Do not send automated queries of any sort to Google's system: If you are conducting research on machine translation, optical character recognition or other areas where access to a large amount of text is helpful, please contact us. We encourage the use of public domain materials for these purposes and may be able to help.
- + *Maintain attribution* The Google "watermark" you see on each file is essential for informing people about this project and helping them find additional materials through Google Book Search. Please do not remove it.
- + *Keep it legal* Whatever your use, remember that you are responsible for ensuring that what you are doing is legal. Do not assume that just because we believe a book is in the public domain for users in the United States, that the work is also in the public domain for users in other countries. Whether a book is still in copyright varies from country to country, and we can't offer guidance on whether any specific use of any specific book is allowed. Please do not assume that a book's appearance in Google Book Search means it can be used in any manner anywhere in the world. Copyright infringement liability can be quite severe.

About Google Book Search

Google's mission is to organize the world's information and to make it universally accessible and useful. Google Book Search helps readers discover the world's books while helping authors and publishers reach new audiences. You can search through the full text of this book on the web at <http://books.google.com/>

The Library of



Class En 620.5
Book fw 521

WESTERN ELECTRIC

VOL. VI. NO. 1

NEWS

MARCH 1917



Dear Friends -
Please come
to my birthday
party March
1st 1917.
I am 5 years
old.
@Willie @News

- VOL V 1916-17
- VOL IV 15-16
- VOL III 14-15
- VOL II 13-14
- VOL I 12-13

PETEE



It's Economy to Take Care of Fine Clothes

The old-fashioned washboard method is hard on the clothes, hard on the help and slows up the housework.

The new way cleans the clothes by gently rocking them through hot suds. For "Clothes Insurance" get a

Western Electric Washer and Wringer

Here is an economical purchase at even an apparently large investment. But one hundred dollars is not a lot of money when figured as a business man does—on a *dividend* basis. Your "dividends" will be clothes and linens that wear longer and look better, and labor saved.

The Western Electric Washer cleans thoroughly and without damage. It turns wash-day and iron-day into one "laundry day," whether you yourself, your maid, or a laundress employed by the day does the work. At the existing high cost of domestic labor a Western Electric Washer will soon pay for itself.

There is a plan by which you can have a demonstration right in your own home. Write for details and a copy of Booklet No. 99-AT.

WESTERN ELECTRIC COMPANY

INCORPORATED

New York
Buffalo
Philadelphia
Newark

Atlanta
Boston
Richmond
Savannah

Pittsburgh
Birmingham
New Orleans
Cleveland

Chicago
Cincinnati
Detroit
Milwaukee

Kansas City
Indianapolis
Minneapolis
St. Louis

Denver
Dallas
Houston
St. Paul

Salt Lake City
Omaha
Oklahoma City
Oakland

San Francisco
Los Angeles
Seattle
Portland

EQUIPMENT FOR EVERY ELECTRICAL NEED

Advertisement Appearing in a Selected List of Popular Magazines.

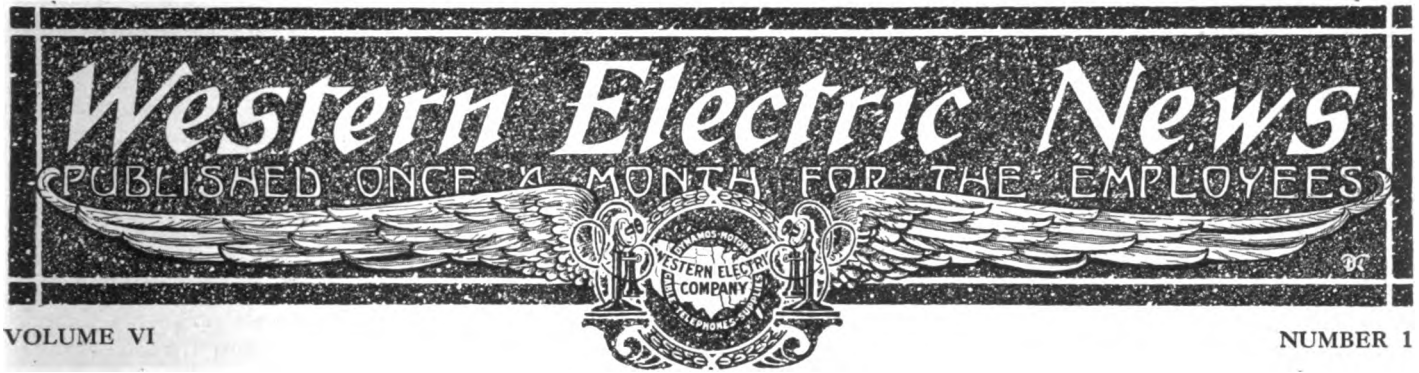

The Progress of Electrical Development

An Address by F. B. Uhrig Recently Given Before the Rotary Club and the Jovian Order at Kansas City

IT has been hard to find a definition for electricity and the reply made by the old lineman to the question of the bystander as to what it really is, is the one that meets with the most common approval. His reply was: "It's juice, just juice, boss, that is mighty powerful and hot." He might have added very appropriately "and the fastest thing that moves." A student of the later school defined it as the "Essence of Pep." Up to less than seventy years ago, it was treated entirely as a phenomenon somewhat similar to radium or liquid air to-day, studied and experimented upon by the various scientists.

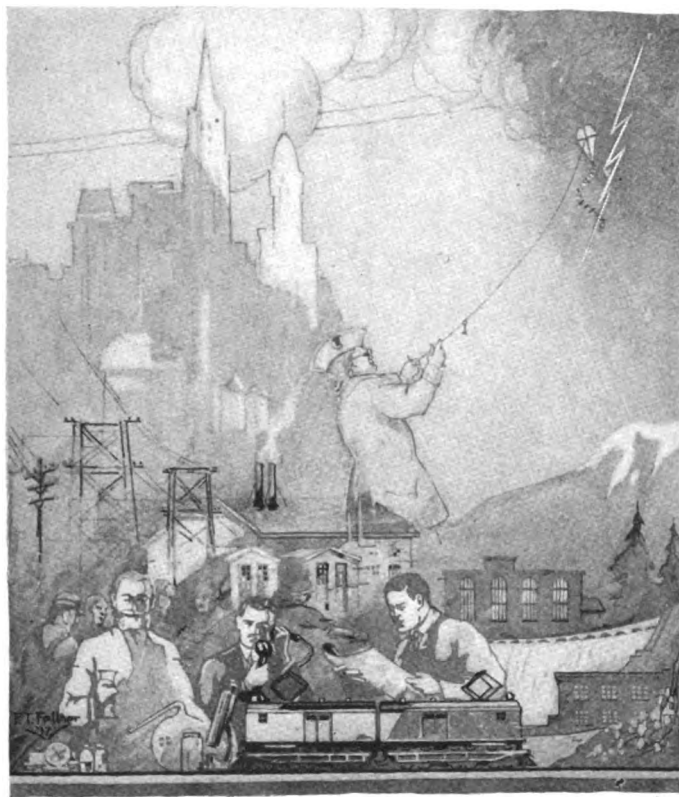

"Through Toil and Ingenuity—Invention After Invention"

We find the honors of electricity distributed among the Italian, the Frenchman, the German, the Scotchman, and the Englishman. I assume you may be wondering what happened to the American when these honors were passed out, and why he did not share them. There were two reasons—as a nation we were so young we had no scientists and few schools of higher education—the other reason was that evidently fate decreed it should be left to the American to perpetuate our honor and glory by deeds rather than by words.

The world owes to Professor Samuel B. Morse the invention and practical use of the electric telegraph and the sending of that famous message from Washington to Baltimore in 1844, "What God Hath Wrought."

To Doctor Alexander Graham Bell we owe the invention of the telephone, who in his work-shop at Boston in 1876 spoke to his assistant the first words to be understood over the wire which were the simple words, "Mr.

Watson, come here, I want you." Last year on the completion of the trans-continental line between New York and San Francisco, Doctor Bell at the New York end of the wire repeated these same historical words to Mr. Watson, who was in San Francisco, and he replied in his customary humorous style, "I shall be glad to, Doctor, but don't expect me quite as promptly as I responded in Boston forty years ago."

To Mr. Edison, we owe the invention of the incandescent lamp, which has turned night into day, especially along Broadway.

I could go on naming many others who through their toil and ingenuity have brought forth invention after invention, but these three men alone are enough to counterbalance the honors held by our ancestors across the sea.

We have become so accustomed to the benefits these men have bestowed upon us through their constant use in our daily life, it is hard for us to realize what it all means. What would actually happen if through some strange freak of nature, we should wake up some morning and find the simple combination of various metals, properly associated together, had failed to perform their customary functions and bring forth the results heretofore obtained?

We would press as usual the button and have no light; after blaming the light company, we would go to the telephone to find out what the trouble was, put the receiver to our ear and wait impatiently for the sweet voice, "Number, Please?" which would fail to respond. Immediately another public utility would be in bad repute. We would then proceed to use the automobile, only to find some-

thing wrong with the ignition and our Twin Six or "Tin Lizzie" would be only an ornament. Our last hope would be the trolley car, but no car in sight. As a last resort, we would think of Dr. Flynn and walk to town, eagerly scanning the streets for a newsboy and a paper to find out what it was all about, only to find there was no paper because the motors had refused to drive the presses.

Are we not right in the position which we, in the business, take, that electricity is the most useful servant of mankind? Seventy per cent. of the people of this country use it in some form or other every day of their lives.

The industry divides itself into three main divisions, the telephone, telegraph, and light and power service.

While to the layman the telegraph has apparently made little progress from the beginning—we seem to write out our message in the same old way, call the same speedy messenger boy and read the same reply as we did years ago—there really has been a most remarkable development in the actual transmission of the messages over the wires. An operating room of the Western Union Telegraph Company is a wonderful and interesting place.

In the telephone you have seen more apparent and marked progress, the mastering of the distance between points of conversation has been a continuous one since 1876, and gradually the scientists and engineers have wrested from nature scientific secrets one after another, until a little over a year ago the transcontinental line between New York and San Francisco was completed and the hundreds of thousands of visitors to the Panama Exposition listened daily to the young man at New York telling them the latest news and letting them hear the roaring of the waves in the Atlantic Ocean.

The lighting and power division undoubtedly shows the

progress that appeals most to the ordinary citizen and it is in this part of the business that we see the most interesting and valuable development from year to year.

The revolutionizing of transportation through the means of the trolley car is well known to you, but I sometimes wonder if we stop to think what a nickel brings us to-day in the way of transportation compared to what we received before the trolley became our obedient servant. Just picture if you can the old mule cars with their hay and stoves and room enough for about three fat men, or their successor, the rickety, jerky cable cars with the same heating facilities and imagine how you would feel riding from Quindaro to Swope Park in them, and having the conductor collect an additional nickel every time you traveled the distance equal to that made by the mule cars. Would you not prefer the ride now afforded you in one of the modern cars, propelled, heated and lighted by electricity for the payment of but one nickel as you enter? The same is true of Interurban service.

The electrification of the steam roads is already under way. The little booklet issued by the Milwaukee and St. Paul Railroad Company is worth while reading to any one who is interested in what has been accomplished and what is before us in this direction. In the advertising business the electrically lighted sign occupies a most conspicuous place. You may have noticed the new talking electric sign recently placed in service in some of our larger cities. These signs are most wonderful pieces of electric mechanism, through which any message can be flashed in electric letters as quickly as the words can be written on a typewriter.

The electrical business has, from its earliest days, been one in which the value of co-operation has been recognized



Suppose That Suddenly There Should Be No Electricity

and practised. This co-operation, gentlemen, is not that kind the law looks upon with disfavor. The electrical industry owes much to the patent laws of this country. We work closely with the government in many directions, they respect our work and we respect its laws.

The co-operation has been along the line of combining the useful elements and the elimination of waste. As an example, the Madza Lamp is protected by patents. The owners of these patents have been liberal in their licensing arrangements under which different manufacturers can avail themselves of the right to manufacture legally. These manufacturers have combined their laboratories and experimental work so as to perfect the lamp with the greatest efficiency and the least expense. The National Lamp Association spends some \$600,000.00 each year in this work of development and perfection, a sum no individual manufacturer could afford. The result of this is that the incandescent lamp is one of the few items on which the cost to the consumer has not advanced. In fact, the whole trend of the business has always been in the other direction. The cost of current and the cost of appliances have grown less and less to the consumer, while the efficiency has increased from year to year.

The Well-Known S. E. D.

This same spirit of co-operation exists in the promotion of the use of electricity for all purposes. It was realized some years ago by men standing high in the industry that a dollar spent to create new business was better than the dollar used in advertising to wrest existing business from each other. The Society of Electrical Development was the outcome of this realization. The society is composed of the leading manufacturers, jobbers, contractors, and central stations in the business, who contribute annually to the society a small proportion of their usual advertising expense, based on the business they do, and the money so contributed is used for the general good of all. The society sets aside a week each year, as its special week, during which the electrical business is brought concertedly and effectively before the public. This year, this week, has been designated as "America's Electrical Week." This name is indicative of the principal work undertaken by the society this year. As you know, the Statue of Liberty has stood in New York Harbor many years. It has served its purpose admirably during daylight, and for a long time an effort had been under way to make it equally efficient at night. This work lay more or less dormant until the society, co-operating with the *New York World*, undertook the task to provide proper illumination. Due to the good work of the society, the dimes and quarters contributed from all over the country have provided the necessary endowment fund. The President of the United States and many other notables were present recently when the work was completed and the Statue stood forth under the remarkable effect of the floodlights—and hereafter it will prove the same welcome beacon to both the foreigner or to our citizen homeward bound, in the darkest hour of night, as it welcomed them during the brightest sunlight in the years that have passed.

Incidentally, the society has compiled data which show that there are five million people, or 5 per cent. of the people to-day, who derive their living, directly or indirectly, from the electrical industry.

Referring back again to the development in the lighting and power end of the business, it has only been during the past few years that the art has progressed far enough to provide any kind of dependable or serviceable devices for use in the home, except the incandescent lamp and the telephone. On the table before you is an exhibition of what has been accomplished in this direction within the last eight years. In addition to what is before you the electric vacuum cleaner and electric washing machine should not be overlooked as favorites of the modern house-keeper.

On the Farm

Not only do these benefits accrue to those of us who live in the city—but the rural communities and the farmer are quick to appreciate its advantages. The modern farm house is considered incomplete without electric service, secured either through a connection with the transmission lines passing close to the farm or through the means of an inexpensive but dependable isolated plant from which the farmer makes his own current—he has known the value of the telephone for many years.

A speaker before the Conservation Congress in Kansas City, some five years ago, was contrasting living conditions on the farm at this time compared with those of former years; among other things he said:

"I live nearly four miles from the city, the telephone enables me to send and receive telegrams, it enables me to call and get a physician in a moment."

I know of no one thing that hangs more heavily on the mother than the fact that when sickness comes, or an accident, it is so long before one can be sent to the physician and the physician brought; to-day with the telephone we cut in half, at least, the time between the accident and relief.

When *The Republic* Foundered

But what can be the comparison of this picture and the anxious mother in the isolated farm house with that scene which happened sometime previous, on the great ocean liner, *The Republic*, as she lay disabled and doomed off the banks of Newfoundland, awaiting the moment she was to sink to the bottom of the sea? What were the anguish and anxiety of that mother compared with that of the 1,500 or more passengers and crew as they turned their faces and their hopes toward that little compartment in which sat that young man sending forth from his finger tips their frantic appeal for help. They could trace their call only from the instrument up through the wires to the mast tops of the ship, they only knew it penetrated that bank of mist and darkness surrounding them, and it was destined only to the starry skies of heaven above? What must have been the emotion and feeling stirred within their hearts when like a message from their guardian angel came the answer, read to them by their captain that the good ship *Baltic* was speeding towards them and their rescue was assured. The wireless and the *Baltic* did not fail them and every one of those 1,650 souls were landed safely in New York.

Gentlemen, for some unaccountable reason history has placed upon its highest pedestals and has devoted its pages almost exclusively to the accomplishments of the statesman and the warrior. I have no doubt that out of

the terrible conflict now raging in Europe will come other names that will be accorded similar places and similar pag, but may not we, who are the living witnesses of their deeds, and who are also the beneficiaries of the work of such men as Marconi, Edison, Bell and Morse, hope the day is close at hand when history and posterity will accord the distinction and honor so richly deserved to these men and to the many other scientists and inventors who have spent their weary, dreary, lives in the laboratory, or at the work bench wresting from nature those wonderful secrets that mean so much to us all.

In closing, I want to leave with you this thought, I hope to see the day when every school house in America, and especially in Kansas City, will contain within its walls the picture of Washington, and on one side of it will be the American flag, and on the other a copy of the Constitution of the United States; that it will contain a picture of Jefferson and placed on each side of it we shall find that of Cyrus H. McCormick, whose reaper vitalized

the Louisiana Purchase, and made it the garden spot of the earth, and on the other side that of Robert Fulton, whose steamboat made Kansas City the metropolis of this garden spot. I want to see hung beside the picture of Lincoln those of Morse and Bell, whose telegraph and telephone have knit and woven together all of the people of this nation so closely, so firmly, and I might say with that spirit of affection, that the cause Lincoln stood for will prevail forever: "That this government of the people, for the people and by the people, shall not perish from the earth." I want to see a picture of Lee, and next to it one of Eli Whitney, whose cotton gin brought forth more happiness and prosperity from the cotton fields of the Southland than all of the slaves that ever lived in America. I want to see hung next to Grant that of Edison, whose electric light, phonograph, and moving pictures have brought to the people, more peace, greater comfort, and more happiness than have ever been enjoyed since the dawn of civilization.

The Tarrytown-Nyack Cable Laying

THAT portion of the Hudson River which Washington Irving once referred to in one of his stories as "the lazy bosom of the Tappan Zee" became somewhat ruffled not long ago when some 14,000 odd feet of Western Electric cable and two huge submarine loading coils were lowered to the bed of the river under the direction of the New York Telephone Company. The object was to connect Tarrytown with Nyack, across the river.

After preliminary conferences with representatives of the engineering department of the New York Telephone Company and the American Telephone & Telegraph Company, Hawthorne set to work to turn out the required equipment which was:

Four pieces of submarine cable, 2,450 feet long; one of 2,260 feet and a sixth of 2,940 feet.

Two monstrous loading coils, weighing over 4 tons apiece, and measuring over 15 feet.

Since each of the three loading sections of the cable had to have its quads balanced at a splice made approximately in the center of each loading section, the cable was ordered in six sections as enumerated. Two of the splices were made at Hawthorne; the third balance splice had to be made after the cable was laid, when the exact amount of cable necessary was known. The total weight of the cable finally used exceeded 90 tons.

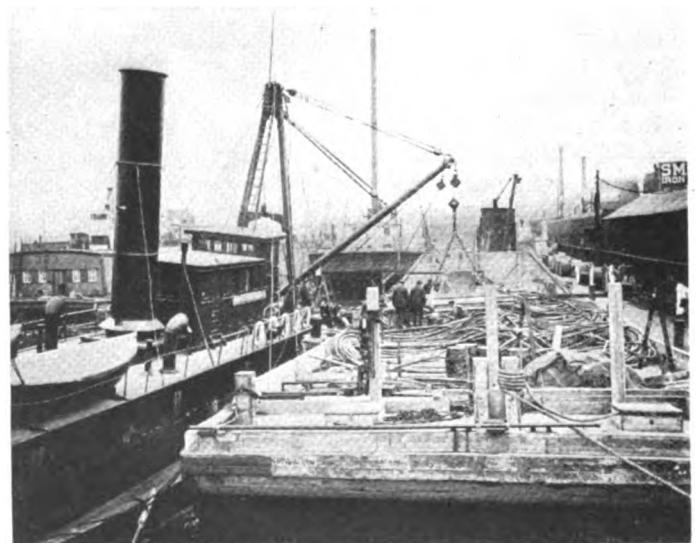

The 16,000-pound Strand Run from Shackle at the Top of the Sling and Fastened to Cable to Ease the Strain Near the Loading Pot When Lowered Into the Water

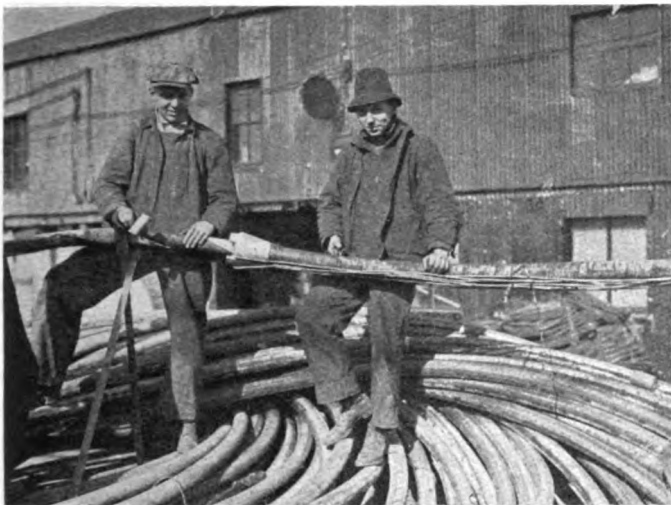

Armour Wire Bent Back Around the Cone. An Interesting Operation of the Cable Laying



And Served with No. 9 Galvanized Iron Wire



How the Reels Were Jacked Up and Braced in the Laying of the Tarrytown-Nyack Cable

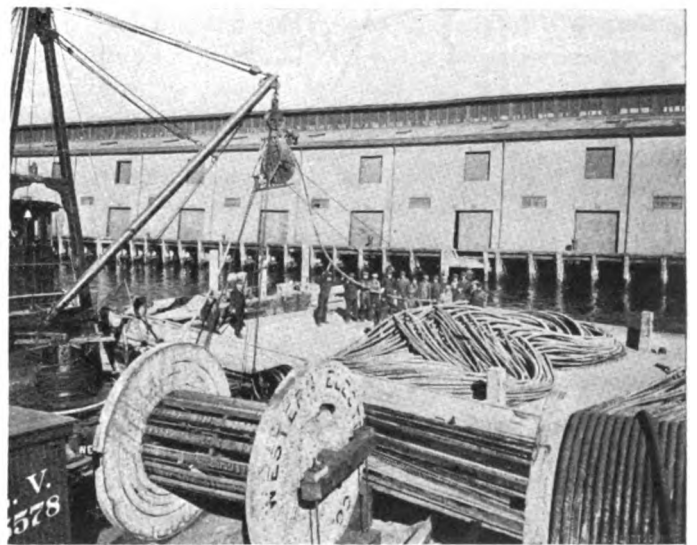

Do You Know What a Gimick Is? Well, This is One Hanging from the Boom of the Cable Boat



Results of New Customers and New Business Contest for December and Twelve Months of 1916



THE salesman securing the largest number of new customers during December was A. Schwenk, Chicago. The salesman securing the highest number of points for sales to new customers for the period ending December 31st were: B. P. Martinson, New York, 862 points; J. R. Stuard, Philadelphia, 596 points; C. C. Caven, San Francisco, 453 points.

Married

- January 18th.—Miss Edna Lipina, department 7381, Hawthorne, to John Cslopiniski, of Chicago.
- January 17th.—Miss Helen Fahey, department 7381, Hawthorne, to Christopher Karney, of Chicago.
- January 20th.—Miss Katie Fisher, department 7381, Hawthorne, to Stanley Wesolowski, of Hawthorne, Ill.
- February 2nd.—Miss Elizabeth Lankovsky, department 7381, Hawthorne, to Joseph Polopensky, of Springfield, Ill.
- February 10th.—Miss Rosie Mostowska, department 7381, Hawthorne, to Anthony Vechrnsky, of Chicago.
- February 3rd.—Miss Sophia Vopat, department, 7381, Hawthorne, to Charles Vosyka, of Chicago.
- February 17th.—Miss Nell Lipina, department 7381, Hawthorne, to Wicenty Wtodowski, of Chicago.
- February 3rd.—Mis Mae Van Cura, department 7393, Hawthorne, to John Brendac, of Chicago.

How the Repeater Repeats

A Twentieth Century Fairy Tale

By I. Manutt

REMEMBER the little girl in Peter Pan who came close to the footlights and appealed earnestly to the audience like this:

"You do believe in fairies, don't you?"

You probably smiled; maybe you had a couple of kiddies of your own, and the smile was for their benefit. But deep down in your heart did you feel like smiling, or were you sadly wishing you could believe in such foolishness?

The inevitable butcher, baker and candlestick maker, to say nothing of the landlord, all act to force upon us the unwelcome belief that only hard work and real money will bring us the pleasures our ancestors are said to have sometimes enjoyed as a reward for kindnesses to fairies in disguise. Friend wife's new lid, though unsubstantial, must be paid for with good hard iron men out of the weekly envelope, which always seems just too thin for all our needs. But all of us are not so constituted; to a few is granted, so 'tis said, the ability to hold communion with the "Land of Dreams."

For hundreds of years poets have sung of Faerie Queenes, Golden Fleece and other confidence games. It got so bad at one time that to protect the people the police made all poets take out a license and to this day you hear a raw piece of work excused on the ground of poetic license. Another class of humans who have dealt in fairy tales are prophets, but they have generally died out in these days of strict sanitation laws.

A new cult has, however, sprung up during the nineteenth century which far exceeds the prophets and poets of the past in the unbelievable kind of stories they tell of things no one has ever seen while awake and sober. This curious sect is generally known as the "highbrow bunch," and they must be treated in accordance with certain traditions which have grown even in the last hundred years or so. When approaching them it is necessary to walk softly with a sidling motion

so as not to disturb their meditations; also never mention money even in ordinary conversation as they are very sensitive on this matter and cannot bear to hear anything about expense. They also require a special atmosphere in which to work and certain very special rooms have been constructed in our West Street building in which these highbrows function. These rooms have been called cloisters.

The highbrow is difficult of approach but every one knows you can get nothing definite out of a poet; they are almost as vague as salesmen. On the other hand our friends of the elevated domes would satisfy even the income tax collector. They certainly can tell the weirdest fairy tales you ever heard, all accompanied by a brainstorming mass of figures which leaves you gasping with admiration. Baron Munchausen could tell stories, and the Senator from Sorghum Center can explain why he didn't extract more nourishment from the pork barrel for his home town, but neither of these members of the Ananias Club has anything on our cloister boys.

Their explanation of the problem, "Why does a hen cross the road?" is so full of square roots, differential increments and other mathematical signs including π , that you would be hopelessly exhausted and anyway maybe you don't believe in signs.

Well, here is their answer to "How does a repeater repeat?" In the first place they refer you way back to the grandfather of all highbrows, Clerk Maxwell, who could make the calculus do ground and lofty tumbling and eat out of his hand. In fact from all we know of this gentleman we believe he was probably the only man that ever lived who could answer all the questions the

comptroller asks before the books are closed. Well, our highbrows tell us that he found it convenient to demonstrate some of his theories by the fairy method, only he called them "daemons." They didn't have any comptroller where he worked or he never would have gotten

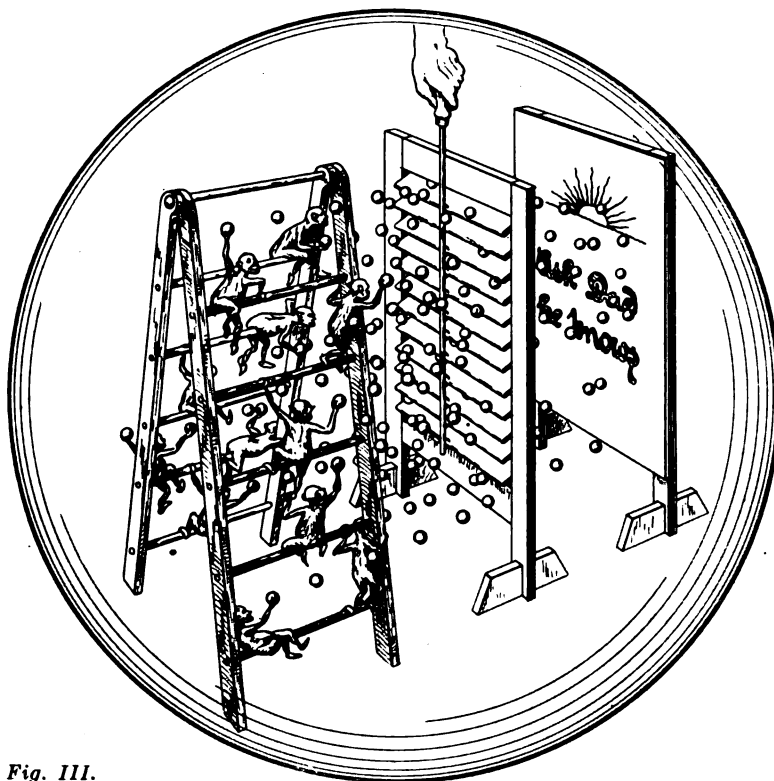

Fig. III.

away with it. By bringing in a daemon, however, he proved that it might be possible to heat a small quantity of gas or air from a larger amount at a lower temperature. In other words, you could get hot air from cold air if you had a daemon to assist you. Now you can guess how Happy Hottentot Harry keeps up his supply. But where does he keep his daemon?

You all remember what you learned at school about matter being made up of molecules and molecules being made of atoms beyond which matter is indivisible. That is, with a meat axe, like Jack Lyng talks so much about, you can divide a substance into small pieces like hash; and with a microscope and hair-splitting equipment like that of another prominent engineer you can divide a substance into pieces smaller than the naked eye can distinguish; after that by means of chemicals you can separate molecules from each other although you can't see them even with a microscope; then with more chemicals you can separate the atoms from each other, but beyond this no treatment has any effect; at least that's what we learned at school and that effectually proves that there are no such things as fairies or daemons. But now come our highbrows with another story. Mind you, you don't have to believe it. They say that atoms may be made to throw off particles like a small boy throwing gravel at the passing trolley car, only the kiddies do it voluntarily for the fun of the thing, whereas the atoms must have some provocation; for example, if they get good and hot they commence to throw gravel like a terrier pup at a woodchuck hole.

Now, all ordinary people know how to take such talk as this. It's just like Arabian Nights and Dr. Cook stuff about stones talking and mountains splitting open, or the beautiful stripes around the North Pole. Nevertheless one of our cloister experts will draw you a picture like Figure 2, to represent the interior of one of our repeater bulbs, shown in Figure 1, and says that "f" is a filament which is heated red hot by the electric current from battery "A," and "P" is a plate which is connected to the outgoing line. In the space between the filament and the plate is the piece of picket fence "g," which is connected to the incoming line, and this gridiron is what puts the fire in amplifier.

To make the matter clear as a fairy tale should be, look at Figure 3, where instead of a filament there is an iron stepladder on which you can see a lot of atoms, or daemons—it doesn't matter which you call them—and on the other side you see the plate as in Figure 2. Between these two is an ordinary window blind with slats which are all operated together by the usual center stick. Now, suppose a strong electric current is passed through the iron step-

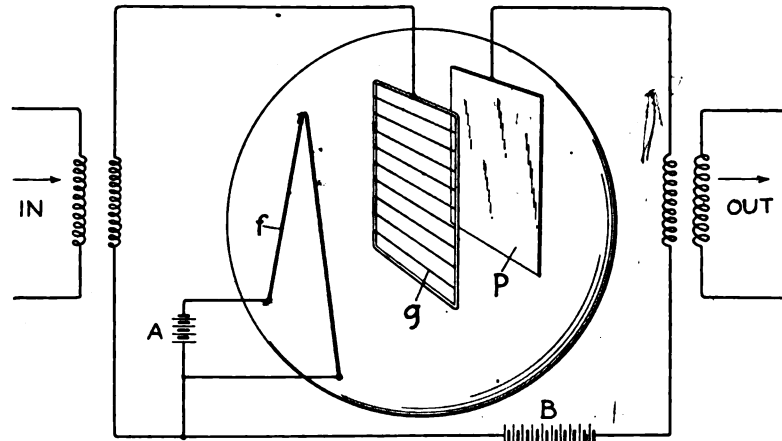

Fig. II.

ladder so that it heats up like the filament in Figure 2, then each little daemon gets as mad as a hen on a hot griddle and begins to throw pebbles at the window shutter. What's that! Where do they get the pebbles? Say, this is a fairy story and you must not ask foolish questions; besides the high-

brows are stumped by this question. Lord Kelvin thought the atoms were made of these pebbles or corpuscles, and that these corpuscles were electricity itself, hence the name electrons. In other words, matter is made of electricity and electricity is imponderable; therefore, there is no matter, and if that is no matter we should worry.

If while the daemons are bombarding the shutter we should open the slats, enough pebbles would go through and strike the plate to make a noise like a hailstorm on a tin roof and the number that strike the plate would be in proportion to the amount the slats are opened. Therefore, if the slats are opened and closed in time with music it would be possible to play a tune on the plate, and if each electron carried a little bit of electricity with it, the effect would be like a current from the stepladder to the plate, and this current would pulsate, increasing when the slats are opened and decreasing when they are closed.

This is just what happens in the repeater bulb shown

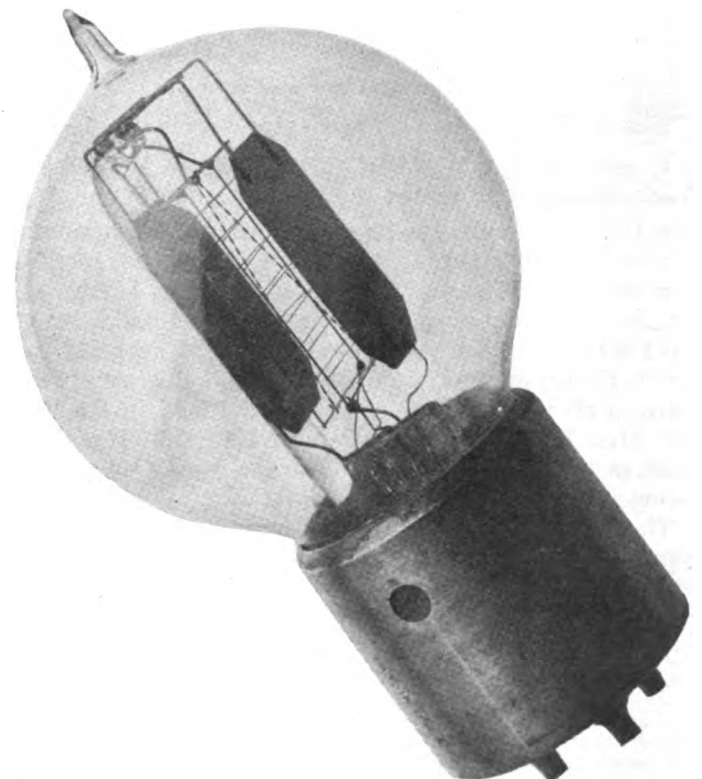

Fig. I.

in Figure 2. The filament is heated red hot by the current from battery "A," and at this temperature millions of corpuscles or electrons are thrown off. The electric current is not necessary to cause this; the same thing would happen if it were heated by a gas flame. These electrons are considered to carry charges of negative electricity itself. Here again we should worry, because the result is the same, no matter what anyone thinks; because a current actually does flow from the filament to the plate.

You all remember that unlike polarities of electricity attract each other while like polarities repel, and so if the gridiron is made negative to the filament the electrons will be repelled by it and very few will get through between the slats; in fact, if the slats are too close together no electrons at all will get through to the plate. The effect would be the same as though the slats in Figure 3 were entirely closed.

In an article on "How the Telephone Talks," in the May, 1912, issue of the News, it was shown how the sound waves produced electrical pulsations in the line; and you have only to imagine these pulsations of current coming to the induction coil at the left side of Figure 2. These pulsations are, of course, very weak because of the long line over which they have traveled and the purpose of the repeater is to amplify or strengthen these pulsations.

Now, while it takes considerable power to open and close the slats of a window blind, especially if you painted them yourself last spring, the operation of the electric shutter is frictionless and even the weak impulses of speech transmitted over 500 miles of line are sufficient to give the desired results so that as each increase or

decrease of current raises or lowers the negative potential of the grating "g," more or less electrons each with its infinitesimal charge of electricity get through from the red hot filament to the plate and give the exact same, but much stronger, impulses of current from the plate to the induction coil at the right side of the picture, and so on the line for another 500 miles, the amount of additional pep put in the impulses depending on the strength of the battery "B."

Now you are probably wondering why this apparatus is put in a glass case. The reason is that the scheme will only work in a very good vacuum because a clear space is necessary for the electrons to travel in. You must remember that everything, even an invisible gas, is composed of atoms, so if there was air or any kind of gas in the space between the filament and the plate the electrons would bump the atoms of the gas while the daemons might put a good many across, the number would not be constant from minute to minute, depending on how successful they were in dodging the atoms and the result of this would be a jerky current which would entirely mask the telephonic pulsations. Therefore, in order to obtain the required accuracy of control of the rate at which the electrons strike the plate it is necessary to pull out of the space between the filament and the plate every loose atom that it is physically possible to get hold of.

This is so important that our highbrows have developed an extremely interesting method of inducing daemons themselves to call the game when the space is cleared, but that is another story to be told when you have recovered from this one.

FOREIGN NOTES

London

H. Barnett, Correspondent

Western Electric men and women wherever they be will be glad to know that the strenuous times at the London Works have not prevented the Social Section of the Athletic Club from pursuing its usual activity. Each monthly social held in the Factory Mess Room has resulted in a substantial cheque for some good cause, besides affording a pleasant time to the employees. In addition to the £26 mentioned in the June, 1916, News, over £32 was sent to St. Dunstan's Hostel for Blinded Soldiers and Sailors as a result of a Fancy Dress Social held in the Factory Mess Room on Friday, October 13, 1916. Mr. F. H. Wilkins, General Manager in Europe, was good enough to preside and presented the prizes.

The November Social, presided over by Mr. F. Martin, Superintendent Operating Branch, was also a great success. It was held on Friday, November 10th, and the proceeds were devoted to entertaining fifty wounded soldiers to a hot luncheon. The following details were supplied by one of the committee:

"The employees of the Woolwich factory on December 16th entertained a party of 50 wounded soldiers from the Herbert Hospital, Woolwich, to dinner, tea, and an entertainment, the funds being provided from the proceeds of a social held in November.

"Mr. A. T. Turney, Cable Contract Manager, presided as Chairman, assisted by Mr. G. C. Goodburn, Employment Manager. The

waiting was done by six Western Electric girls and eighteen others helped to entertain."

During December the news came to hand that the Victoria Cross had been won by Private (now Corporal) Edwards, who, as already announced, worked at the London House for a time just before war broke out. A suggestion was made that the London employees would like to show their appreciation of Edwards' gallantry. The Social Committee took the matter up and subscription lists were sent round to which the company also contributed. The result was the presentation of a gold watch suitably inscribed, also a gold chain. Mr. A. T. Turney made the presentation at a Social held on January 12th at which Corporal Edwards attended.

On the same date (January 12, 1917) news was published that Private W. Keleher had been awarded the Distinguished Conduct Medal for leading a bayonet charge, and rescuing an officer. Private W. Keleher was a boxer and sportsman in the truest sense of the word. We are naturally proud of the distinctions thus won. They comprise: Corporal Edwards, V. C.; Sergeant J. B. Hill, D. C. M.; Private W. Keleher, D. C. M.; Lieut. A. J. Pearson, Military Medal, and Lieut. Wilkins awarded a commission for conspicuous gallantry and for carrying in a wounded officer. On top of this, a number representing about 75% of the man power of the London works are serving their king and country.

Cross Talk in the C. R. & I. Shops

The Stranded Locks

The Mystery of a Cable Deficit

"THIS is the watchman at Gate No. 20, Mr. Willard. Mr. S. Holmes is here to see you. Shall I let him come up?"

The telephone diaphragm crackled with the vigor of Willard's reply. "Let him come up! Sure, let him come up. Stanley Holmes don't have to get permission from me to get into Hawthorne. Aren't you honoring photographic passes any more, or what the deuce is the idea anyway?"

"But this isn't Superintendent Holmes, Mr. Willard," answered the watchman. "His card reads, 'Sherlock Holmes.' A Dr. Watson is with him. They say that they have a letter from you."



Bill Johnson's Miss Stake—Or Why the Waiter Did Not Bring the Pork Chops He Intended to Order

"Where in Sam Hill did they get a letter from me, I'd like to know. Well, send 'em up, anyway," and Willard slammed the receiver back onto its hook.

A moment later two strangers entered the office. One was tall, lean, and obviously English. His companion was less tall and less lean, but no

less obviously English. After one sharp glance about the room, the tall man spoke:

"I observe that you have a box of Perfecto de Cabbage-Hemp in the upper left hand drawer of your desk."

Willard jumped. "By the right hind foot of the Great Horned Toad, how the Sam Hill did you know that?"

"I observed that this office is at least 20 degrees warmer than the outside room, although both are on the same heating system. Now what would cause the difference? You may have read my monograph, 'The Heating Value of Fuels,' in which I state that cabbage ranks with anthracite in calorific power and is only surpassed by hemp. As cigars have been a hobby of mine, I know that the most perfect cigar from a heating standpoint is the Perfecto de Cabbage-Hemp. Following my deductions further, my dear Watson, you will notice that the upper left hand drawer of the desk shows excessive wear, while the remaining drawers appear as new as if they were installed yesterday."

"Marvelous, perfectly marvelous!" came from Dr. Watson.

"Thanks, I believe I will smoke one," continued Sherlock, as Willard acted on his hint. "And now to business. This letter reached me in London. Following my marvelous deductive methods, I determined by reading the letterhead that the communication came from the Western Electric Company's Hawthorne Works."

As he spoke, the great detective drew from his pocket the following letter, which he handed to the astonished Willard:

"Mr. S. Holmes:

"I have written to Mr. Robbins about the part the Inspection Department must take in our increased production. It is a mystery to me why we can not increase our output satisfactorily. I would like to have the benefit of your experience.

"F. W. Willard."

"While you were deducing, you might have deduced that that letter was intended for S. S. Holmes, our Superintendent of Inspection, but was sent astray by a bone-headed mailing clerk," remarked "Wad" ruefully, as his mind pictured himself explaining a huge detective bill to his boss. "Well," he added, "as long as you're here, Mr. Holmes, let's see what you can make of this:

"Last June our production of cable began to fall off unaccountably and the slump has continued in spite of all we can do. Now, we absolutely must get an output of 250,000,000 conductor feet of cable per week. It can't be done unless the cause of this slump is discovered and removed. Now, what's the answer?"

"Watson, what do you make of that?" queried Holmes.

"My dear Holmes, it must be on account of the war," hazarded Dr. Watson.

"Good!" exclaimed Holmes, "Excellent, Watson! You are improving. Since June is hotter than what General Sherman said war was, you deduce war. Excellent! But you overlook one fact, my dear Watson. There are other brides besides war brides. Mr. Willard, could we see your most bashful bachelors?"

Mr. Willard rang for the office boy. "Send in Mr. A. P. Peterson of the Chemical Methods Research Section," he directed.

A moment later Peterson appeared in answer to the summons. The great detective eyed him keenly. "I observe, Mr. Peterson," he remarked at last, "that you are not married."

Pete's gasp of astonishment was drowned by Willard's "Well, I'll be ——," and Dr. Watson's exclamation: "Marvelous, Holmes! How do you do it?"

"Elementary, my dear Watson," responded the criminologist modestly. "Even you might have noticed that Mr. Willard summoned him in response to my request to interview his batch of bachelors."

Again he fastened his keen gray eye upon Peterson. "Young man," he questioned severely, "are you engaged?"

Pete's face assumed the beautiful pink shade of a boiled lobster. "N-n-no!" he ejaculated fervently. "Heaven forbid!"

Sherlock turned toward Willard. "Dismiss this man," he directed. "He is innocent. Any more?"

"Yes, there is Bill Johnson, foreman of our Stranding Department," replied Willard, "but he is a woman hater."

"Tut, tut," replied Holmes, "lead me to him."

Bill was found leaning dreamily against a cable truck. Without disturbing the busy man, Holmes gave him the once over with a powerful magnifying glass. Then suddenly he covered him with a navy pistol. "Date of the wedding?" he demanded fiercely.

"December 23rd," stammered Johnson, "but I've been trying to keep it secret until February 10th, when it would be old stuff. You know," he apologized, "cigars have gone up so since the war."

"There is your answer, Mr. Willard," declared Holmes positively. "No man can keep his thoughts on stranding wire for cable when his wits go straying among the strands of her golden hair. But he is married now and your output will be interfered with no more. To whom shall I present my bill for 500 pounds?"

"Just send it in to the Company, Mr. Holmes," replied Willard, "and thank you."

Big Jim Hottat, who had been taking in the scene, gasped. "Wow!" he exclaimed. "Five hundred pounds—\$2,500.00—for telling him that. And here I've been telling it for nothing to everybody in the Cable Plant ever

since I made Bill 'fess up the day after it happened. Next time I help Bill keep a secret, I'll find out first whether it's worth any money."

Meanwhile Dr. Watson's face wore a puzzled frown. "But, Holmes!" he broke out at last, "I don't see yet how you did it."

"Watson," replied Holmes oracularly, "murder and marriage will come out, but murderers and married men must stay in. Knowing that, the answer was easy. I find a hair on the gentleman's coat, but no feathers. That at once tells me: 'A married man, who cannot go out with the chickens.' The dreamy look said: 'Recently married.' Therefore, the period from June on—which you will remember, was the period of the cable output slump—was the courtship period, when Bill could not keep his mind on his work. Ho, hum. Pawss me the hypodermic, Watson, old chap."

"But look here," protested Willard. "Bill was a woman hater. He often said that if he was ever fool enough to think of getting married he hoped he'd be led to the stake first."

"That explains it," broke in Big Jim excitedly. "Led to the stake! That explains it, Mr. Willard. Her name was Anna Stake."

"Great porterhouse!" ejaculated Willard, "she must be a dear girl."

Mr. Carty a Senior Major in Reserve Corps

THE *Army and Navy Journal* printed the following article in a recent issue:

"Mr. J. J. Carty, chief engineer of the American Telegraph and Telephone Company, and recognized as one of the foremost authorities in the world on wire communication, has been commissioned a senior major in the Signal Officers' Reserve Corps, the reserve auxiliary of the Signal Corps, U.S.A. The addition of Mr. Carty to that organization will be a decided accession and one which will be widely applauded. It is believed other appointments will follow from the ranks of leading American engineers. The importance of the telephone system in any plan of national defense has been accepted by officials of the War Department.

"The adaptability of the American telephone lines was thoroughly proven last summer when the entire A. T. & T. Company's service was turned over to the Government for a test under hypothetical war conditions. When the country's National Guard was mobilized last summer a complete telephone exchange was established at Camp Whitman, in New York State, in less than twenty-four hours after the troops were called out, connecting Washington with Albany, New York, and all the vital points necessary to the movement. The commissioning of Mr. Carty as an officer in the Reserve Corps may be taken as a further step to have this important branch of the country's defensive system ready, not only in material, but in personnel."

Talk About Lack of Moral Courage!

On January 11th, when a 90-mile gale of 5° above zero air was gnawing at human ears on the whole Atlan-

tic seaboard, one F. G. Austin sent the following letter to one A. E. Beling of the Supply Sales Department:

"Would you care to join some of us in having measurements taken for Palm Beach suits? If so, the representative of one of New York's best clothiers will call and wait upon you. The suits will be delivered next summer."

Merely reading the letter, we understand, made Mr. Beling shiver. Not from cold, however. No—from lack of moral courage. If you don't believe it, read his reply:

"Mr. F. G. Austin:

"Thank you for letting me know about this. I don't believe, however, that I can let the Palm Beach suit supplant the fancy array I have already adopted as standard, namely, black and white check Shepherd's Plaid. Last summer I stood all the joshing necessary to having this type of attire identified with myself, so I expect I can reap the benefits of my temerity this summer, and wear the race-track suit in peace. If I attempted to re-standardize again now, you can readily see that I will have to go through a second siege before the populace will permit me to live in peace. Nevertheless, I appreciate your thoughtfulness in letting me in on the proposition, and my only regret is that I cannot join the cream-colored squad next summer.

"(Signed)

A. E. Beling."

Pensioned

C. L. Berg, formerly foreman of the tapping department, Hawthorne, was recently retired on a pension after a continuous service of nearly twenty-eight years. Mr. Berg first came with the company on February 28th, 1888.



American Electricity

By Albert Engstrom

Translated from the Swedish magazine "Vecko-Journalen"

IN mid-ocean I met a young Norwegian engineer. At that particular moment I happened to be in the company of Madame Rosika Schwimmer, discussing war and peace and vainly endeavoring to charm her with philosophy and Germanic scepticism. The young engineer, who knew my opinion of the results of the Ford expedition, all of a sudden asked us to stand still. He wanted to take a photograph of us and, what is more, he wanted to be in the picture himself, for he considered it an historical event. A passing fellow-passenger was hailed and he snapped the picture of the three of us.

I rather liked the engineer; he seemed to be a serious young man, in possession of a considerable store of information regarding the conquests made by Electricity during the last decade. My knowledge of electricity is limited to the Morse Code and to a somewhat inadequate ability—coupled with resentment—to use the telephone. I have seen an effective stroke of lightning and, while at college, I was made to stand on an insulated stool, with my hair standing on end, while they pulled sparks out of my nose and ears. The engineer assured me that Humanity had advanced considerably since I left college. Not that the essence of electricity had been discovered—but we have learned to utilize, in a larger measure, what little we do know.

Well, we met several times on the promenade deck of the steamer—the germ of friendship developed—and one day he suggested that it might be arranged so that I could visit the New York house of the Western Electric Company—the largest company of its kind.

The longest telephone line in the world extends from New York to San Francisco, a matter of 6,000 km. It is a brand-new line, which has just passed out of the experimental stage. The Norwegian engineer—Brofos was his name—further suggested that, inasmuch as I represented (distantly, perhaps) a country boasting of one of the best telephone systems in the world, I might have an opportunity of talking to San Francisco. I replied, meekly, that I did not know anybody in that town—when it suddenly occurred to me that we must have a Consul in San Francisco. All right, I would talk to the Consul.

We arrived in New York. The days went by, and I had almost forgotten Mr. Brofos' suggestion when one morning I received a telephone message to the effect that

the necessary arrangements had been made. The Western Electric Company had, on my account, suspended the telephone traffic between New York and San Francisco and the line would be at my disposal for a quarter of an hour.

Mr. Brofos called for me and we went by the subway to the station nearest to our destination, which proved to be a skyscraper, although one of the minor variety. We entered the most interesting palace I have ever visited. The elevator took us several stories up in the air, and I

was introduced to one of the chiefs. You should have heard me speaking English—aber immer redet man sich! You see, I represented a big nation (telephonically speaking); I was some highbrow, who was going to write a book about America! We spread ourselves around a large table in the directors' room, and smoked Havana cigars, the price of which had probably never been accurately determined.

I was told that I might go through the entire building, and in return I stated that, although I am not a scientist, few people in this world have greater respect for Science than I have. Come to think of it, I believe I made that statement under oath.

Our tour of inspection began. This, the largest and best equipped company of its kind, spends millions annually on scientific work alone. Every year the company sends out trusted representatives to the universities in America and Europe in search of suitable men for the advancement of the ideas propounded by its leading men. Wherever they find a young Ph.D. who is interested in the branch of science which interests the company, they engage that man on the spot. During our tour of inspection it seems to me that I saw some two or three hundred young Ph.D.'s, who were allowed to experiment and who were given material with which to experiment. I was also greatly pleased to find some Swedes—serious young men—who appeared to be very well satisfied, because they had access to all the requisites for a perfect "spree" in the Realm of Science—more particularly that of Electricity.

You may rest assured that there is nothing superficial about the work. These men worked gladly and with perfect ease on the problems before them. I am sorry, now, that I did not make some notes of facts and figures, but I must confess that I was so overwhelmed that the individual was completely forgotten. I was actually in one



Albert Engstrom, the Swedish Mark Twain; Mme. Rosika Schwimmer, of Ford Peace Expedition Fame; and Our Own E. A. Brofos, Representative in Scandinavian Countries

of the world's greatest institutions, the object of which is the utilization of the human intelligence. I saw an electric current of 50,000 volts bark across a couple of wires. I caught a glimpse of the wireless telephone. A small round object—hardly any bigger than a watch—was placed in my hand, and somebody said: "Listen!" I did, and I heard the most beautiful organ music. All these—you understand—are matters which are now the subject of experimental research. I talked to Chicago, and the answer came back—type printed on a roll of paper. Before very long, human speech will be transmitted by wire and printed for delivery. There is no limit to human genius. We are well on the road to becoming little gods. That is—not I, in my humble capacity as an editor of a comic weekly—but all other editors and scientists.

"Close to the Border of Philosophy"

I consider the workshop I saw as one which, more than any others, is concerned with matters spiritual. Here we are, so close to the border of Philosophy that it is almost impossible to discriminate between Science and Philosophy. It is a sheer enjoyment to talk to young scientists who pass from truth to truth and ever conquer new volumes of the vast expanses of thought. They are not astonished at a new discovery—they take it as quite natural and logical, a link in the chain of development which could not have been forged in any other way. Of course, these young men soon discovered my ignorance, but several of them seemed glad when they also found how anxious I was to learn. I felt quite at home among them and should be glad to return in order to learn—just to learn.

Well, the New York to San Francisco line was reported to be ready, and we ascended a few stories and were ushered into the office of the Chief Engineer. I talked to Dr. Westerberg in San Francisco. He assured me that it was very hot in 'Frisco and I told him the same about New York. In that way we got along famously.

After this historical event we returned to our study trip. I was shown somewhat more elementary apparatus; among others a device which automatically calls out the names of the stations during a railroad journey, and which also tells you how long a train will stop at the station. I also listened to a long-distance concert from Chicago where a negro was, just then, producing a gramophone record of a song.

I was just about to express my gratitude for the courtesy shown me and to dive into the crowds of New York, when we passed a room in which a fellow was testing transmitters. He had eight transmitters in front of him and was shouting at them in an incomprehensible language.

"What is he doing?" I asked my guide.

"Oh," he said, "that fellow has a most wonderful voice. He is a real discovery. He should have been an operatic singer, but he really is of greater service to Science where he is now."

"The 8-Hour Shout"

I stood immediately behind the fellow, and felt somewhat ashamed of my conversation with my guide.

"You will notice," the latter continued, "that he has eight transmitters to shout at. His voice is particularly suitable to test the durability of transmitters. We might design a machine to do the work, but it is cheaper his way. He sits there and shouts eight hours a day at a phenomenal salary. And then, he does not always speak intelligibly. He does that only when he remembers that he actually exists, but now, listen, he does not articulate at all—he simply screams. He is a machine—he . . ."

"But how can you maltreat a human being in that fashion?"

"Maltreat? He applied for the job himself. He has the most remarkable voice in the United States. Listen!"

Just then the fellow passed his face along the whole row of eight transmitters. He paid no attention to us. His voice sounded like a giant megaphone operated by a volcano.

"May I speak to him?" I inquired. "Is it permissible to interrupt him for a moment?"

"No. He is busy now. He will be through by six o'clock to-night. You may call on him then if you like. I can get you his address. He lives in Brooklyn."

I have never heard such an awfully powerful voice. Of course, I would not disturb him. But I pondered awhile on his private life. I imagined him proposing to a woman, saying, "Will you marry me?"—in that awful voice. I am sure he could win *all* the women in the world with that voice. If a man says, "I love you" in the tones of a fog-horn, he can get anybody he likes.



J. E. Taylor

The Kansas City house mourns the death of its oldest road salesman, J. E. Taylor, who since 1904, when the business of Kansas City was established, had represented the Company in Southern Kansas and Western Missouri.

He was an ideal salesman, a gentleman always cheerful, optimistic, a hard worker, and a man thoroughly versed in his business. Not alone the Company, but his customers will miss J. E. Taylor.

"His whole life," says F. B. Uhrig, Manager at Kansas City, "was an inspiration to the younger men in the organization."

F. W. Bigelow



F. W. Bigelow, for many years Head Paymaster when the principal manufacturing department of the Company was at Clinton Street and for a number of years Head Paymaster at Hawthorne, and perhaps the most widely known employee of the Company, died

suddenly January 20, 1917. Mr. Bigelow had been in the service of the Company since October, 1890.

The Lake Washington Canal Locks

Large Installation of Western Electric Apparatus in Seattle's Great Locks Built by the United States

By Jo Sorenson



General View of Locks Showing Administration Building to the Left. The Lighting Standards are Unique but Very Effective

FIVE HUNDRED H.P. W. E. Motors; 2,000 K.V.A. W. E. Transformers; 75 feet of W. E. Switch Board; \$5,000 worth of W. E. Supplies—these are the most interesting facts, from a Western Electric viewpoint, connected with the new \$2,500,000 locks recently constructed by the United States Government in the canal joining Lake Union with Salmon Bay at Seattle.

From a commercial standpoint, the importance of the Lake Washington Canal and the newly completed locks is not yet fully appreciated. The vast commercial possibilities of the situation created by the construction of this canal are today being more clearly seen. The linking of Lake Washington and Lake Union, both situated in the heart of the city, with Salmon Bay, Elliott Bay and Puget Sound, gives to Seattle a unique distinction among all seaports. Two large bodies of fresh water are thus at the service of foreign and domestic commerce at this point. More than doubling the present natural facilities of the port, the harbor of Seattle, in extent, in convenient depth of water, in freedom from obstructions of any kind, in climatic conditions, and in ease and safety of approach, is scarcely equalled by any other harbor in the world.

The locks are really two independent locks, lying parallel, operated in a similar manner, but differing in size. The larger is 80 feet wide and 825 feet long, being divided into two chambers, 450 and 375 feet long, respectively. It can be filled in 8 minutes. The smaller is 30 feet wide and 150 feet long, five minutes only being required to fill it. In building the locks exclusive of excavation and right of way, \$2,275,000 was expended. The entire project increased this amount to \$7,000,000.

On gazing into the locks, into its vast chambers, at the high walls and operating houses, one is impressed with the simplicity of the huge structure. Everything is of concrete and steel—the walks, the walls of the mammoth basins, the power house, the spill-way, and even the

beacon posts, from which large nitrogen lamps guide ships through at night. There are no unsightly corners; everywhere one sees pleasing curves of the concrete models, that were made with such good taste. Even the so-called guard walls, used to guide ships in and out of the locks, harmonize perfectly. On the top of each is a broad walk, serving to make a splendid promenade.

The large locks are filled and emptied through immense culverts, 10 feet high at the bottom of the walls, and the amount of water flowing through them is regulated by six valves, operated by 50 H.P. Type M.T. W. E. Motors. The six gates, fashioned like those of the Panama Canal, include three sets of operating gates, in addition to two sets of guard gates. These are double-skinned and carry a certain amount of air to aid in their buoyancy; the

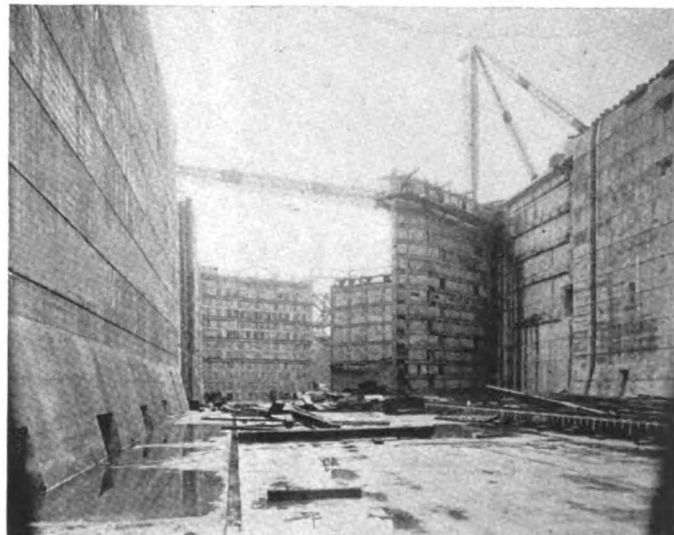

The Culverts for Filling and Emptying the Basins Are Clearly Shown at the Bottom of the Walls

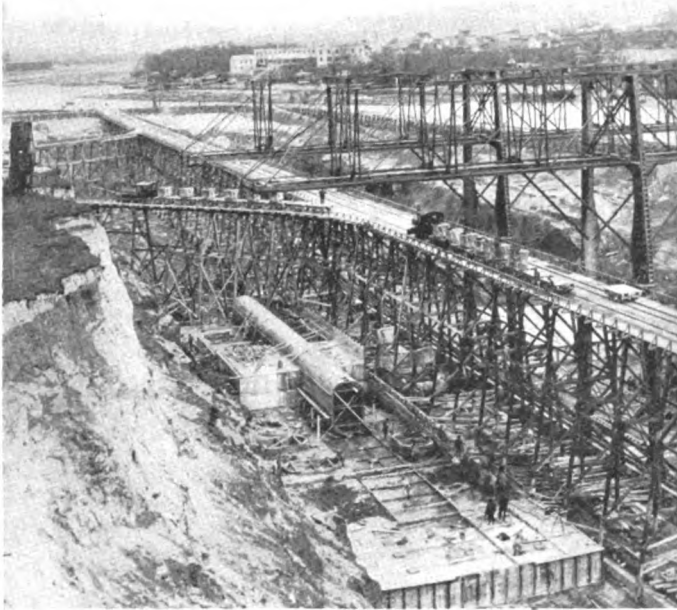

The Immense Size of the Excavation Necessary

highest has an elevation of 53 feet from the sill of the lock. The four main gates are operated by 25 H.P. Type M.T. W. E. Motors.

All the machinery for the operation of the locks, with the exception of the power plant, is housed in chambers within the walls.

A feature is the four operating houses, from which all the machinery in the locks is controlled by operators and assistants; in each of these houses are twelve feet of switch board, and four controllers bearing W. E. nameplates. The power house consists principally of switch boards over 35 feet in length, on which are mounted the various instruments, control and protective devices and a transformer station in which are three 300 K.V.A. and three 100 K.V.A. transformers.

Power is supplied to the transformers at 13,000 volts stepped down to 2,300 volts and then brought to the large distributing panels in the power house. From here the 2,300-volt circuits are led to each operating house, where one circuit is stepped down to 120 volts for light, and the balance to 220 volts for power.

Because of the publicity given the locks, it has become one of the main attractions of the city to tourists and engineers alike. The operating houses are open to public inspection, and scarcely a day passes that visitors do not ply the operators with questions regarding the phenomenon of controlling such vast masses of steel by such small levers. To others, engineers principally, seeking information, the motors, transformers, and power distributing panels are shown. On all apparatus is the name Western Electric most prominent.

Talk About Your Installing Jobs!

THIS is not a movie stunt but a real installing job. The telephone company at West Palm Beach, Florida, recently added a story to its building and called upon the Installing Department to move its operating switchboard to a new location on the added floor, stipulating that the board be *kept in service* during the move. The pictures show how the move was made.

All of the cabling from the distributing frame to the switchboard was lengthened by splicing in additional pieces. The switchboard was moved on to a temporary

platform. Powerful chain falls were attached and switchboard, operators, and all went up by easy stages, through the opening in the floor.

General Foreman W. E. Elrod tells us it was a distinct treat to watch these nifty girls handling their usual burden of calls with apparent indifference to what was going on. The move was completed without service interruption of any sort and so far as the subscribers were concerned, no one knew that anything unusual was transpiring.

Division Foreman E. Arnold and Foreman H. D. McCord were the experts on the job.

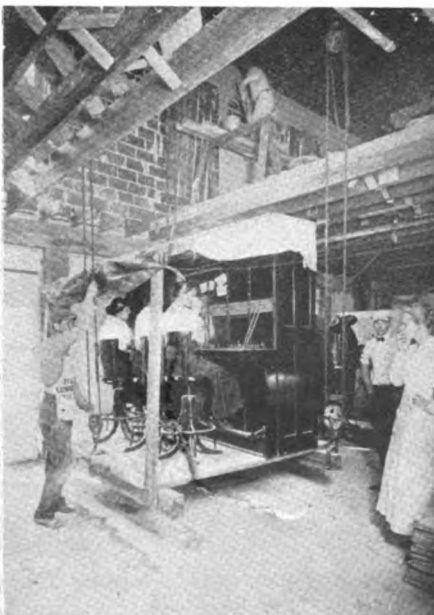

All Aboard!



Going Up!

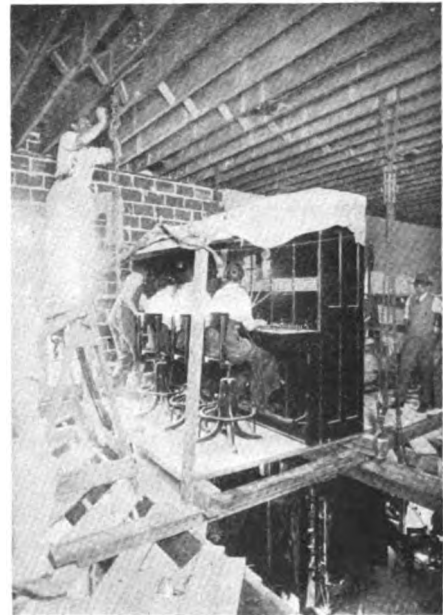

At Last!

Mr. P. R. Goodwin Writes a Letter

Large Words Do Not Daunt Him—He Talks of Many Things—He Threatens To Write Again for the "News"

MY dear Editor:—

When one rises from the level of the seventh floor to the heights of the twelfth, and from the atmosphere of the Manufacturing Department, as popularly conceived, to the rarefied ether of the Engineering Department, one would naturally be supposed to sense the difference; and it might not be surprising, if this were true, that one should appreciate the exigencies of the situation and, after due deliberation and careful consideration, feel that it was incumbent upon him to assume a virtue, though he had it not, and to appreciate the necessity of the assumption of a greater amount of dignity, in view of the examples that he had constantly before him.

But if we assume that one is more or less human and therefore requires an outlet for his inherent frivolity, it might well be supposed that one would seek relief on leaving the building at night—and I will admit that this has been true in my case. The reason for this communication is to be found in an overdose of seriousness, for I think you will agree with me that the making up of the Engineering Department organization chart is a serious matter; and that chart is the immediate cause of this outburst, as after a very serious day it was necessary for me to take home the information bearing on the new chart for the Engineering Department to put it in shape for final consideration.

I did so and, having finished it, I find that it has been too much for me—that whimsical thoughts can no longer be restrained and that I must get them off my mind. Now, nobody in my own family will listen to me, and I rather doubt whether anybody at West Street would listen to all I had to say unless they had to. Therefore, and because there is no one here to stop me, I am taking advantage of the circumstance and writing these thoughts to you. Of course, I appreciate the fact that you do not have to read this, but I think you will.

To return to the organization chart, the fates seem to have conspired against this masterpiece, because I thought I had made every preparation for an uninterrupted evening by sending my family to the "Movies," which, like the small boy's definition of a lie, seem to some of us "An abomination unto the Lord, but an ever present help in time of trouble"; and like the man in Moore's "Night before Christmas":—"I had settled myself down to a long evening's work, when out on the street there arose such a clatter, I rose from my chair to see what was the matter, when what to my wondering eyes did appear"—but a large aggregation of people gathered directly under my window, who appeared to be interested in a fire that was taking place in the apartment below ours. It appeared that the people below had been inconsiderate enough to let their Christmas tree catch fire, and the crowd having arrived, the fire engines followed, and later the police.

It certainly did look as though the organization chart was doomed, as well as the family jewels, because I realized at once that were I rescued, I should have to be carried down the ladder with the Engineering Department

organization chart in one hand and the family jewels in the other. As luck would have it, however, I did not have to be saved: the fire was put out, the crowd dispersed, the police resumed their beats, and I went back to work. Some people would have been glad to be the first to see that chart—I was glad to see the last of it.

Speaking of the fire, however, reminds me of the fire they had in Yonkers when Mr. McGrath lived there. They say that Mr. McGrath was a hero. I have even heard that after carrying a lady down three flights of ladders, he picked up the cook who, according to reports, weighed somewhat over two hundred and fifty pounds, and carried her up, because, as he put it, he did not want to go back empty-handed. This may not interest you particularly. Perhaps he would not like to have it known, but at any rate, it is off my conscience.



Mr. McGrath Was a Hero



The Author's Imaginary Predicament

But that is not all that is on my mind. I am going to write an article, a scientific paper in fact, on a problem that comes right home to every engineer and every engineer's wife; every employee of the Western Electric Company and every employee's wife. The title of this paper is going to be "The Hole Trouble with Swiss Cheese," and what's more, I hope to secure the valuable services of Mr. Housekeeper, because I feel that a housekeeper ought to be of considerable assistance on a subject of this sort.

Now to my mind the trouble isn't so much with the increased cost of the cheese as the increased number and size of the holes. No matter what you pay for the cheese, you get something; but in the holes you get nothing. Of course, you and all the engineers will say, "Give us facts; give us figures." All right, that is where Mr. Housekeeper comes in. He will show by mathematical, hypothetical,

and problematical formulæ what the average number and size of the holes were in the past, what they are now, and what they will be after the war, when mountains of Swiss cheese (and caverns of holes) are unloaded on this country.

When I get his figures, I will write you again. By that

time I shall probably have been to Hawthorne and shall have some Manufacturing Information from C. G. Stoll and Charley Berg, relative to the cost of drilling the holes and the best type of drill to use.

[SIGNED] P. R. Goodwin.

Activities of the Hawthorne Club

The First of the Ladies' Parties

OUR cub reporter looked up from his copy of "The Transmitter" with longing eyes. "Gee," he remarked, "Gee, but wouldn't I like to get a chance to report this! 'Thursday, January 25—Girls' social evening.' Say, one of those girls only-s must be sweeter than a sugaring-off party. If I could butt into one of those I'd be like a bear in a bee-tree—I wouldn't mind being stung a few times."

Now our cub thinks he is some little bear with the ladies and he needed the discipline, so we sent him out with instructions to get a full first-hand report of the event upon pain of losing his reputation as a news gatherer. So he went forth and bought himself a fresh shine (which he needed), paid for a shave (which he didn't need unless viewed through the microscope) and started for the Restaurant Building, whistling blithely.

Next morning he slunk up and handed in his article. It read: "About 250 ladies of the Hawthorne Club met in the Restaurant last night for a social time. Pool, cards, dancing and light refreshments were enjoyed. A special feature was a reading by Miss Bernice LaGess, A. j. g. t. was h. b. a."

Which proves there is no use in trying; it can't be done. The only way to get into these feminine festivities is to be born of the proper gender. So you will have to be satisfied with our cub's meager report and the ladies' assurances that these events are "just perfectly great!"

The plans are to give one of these parties each month.

Choral Section Recital

The Club's choristers gave their first recital of the season January 26th. The chorus, which has been organized but a short time, appeared in a double number, "Boat Song" by Cowen and "Water Lilies," by Linders, both sung remarkably well. The remainder of the program was given by artists from the Bush Conservatory of Music, all of whom well deserved the hearty applause they received. Each responded with an encore. Below is the program:

H. WILHELM NORDIN, Baritone
(Director of Choral Section)
MISS MARIETTA LIVENGOOD, Violinist
MISS LILLIAN FOX, Reader

ACCOMPANISTS

MISS MAYBELLE WELLS
MRS H. WILHELM NORDIN

Boat Song Cowen
Water Lilies Linders

Choral Section

Vulcan Song, from "Philemon and Baucis".....Gounod
Oh, Dry Those Tears.....Del Riego
On the Road to Mandalay.....Speaks
Mr. Nordin

Serenade	Arensky
Liebesfreud	Kreisler
Miss Livengood	
Invictus	Huhn
Ah, Let Me Dream.....	Taylor
In an Old-Fashioned Town.....	Squires
Mr. Nordin	
Management	Anonymous
Miss Fox	
The Trumpeter	Dix
In the Garden of My Heart.....	Ball
Three for Jack.....	Squires
Mr. Nordin	

February Dance

The first entertainment of February was put on by the weatherman—a breezy play, "Alas, from Alaska"—alas, colder than a Boston girl. Talk about your raw performances! One of the worst features was when the thermometer tried to reach that low note at the end of "Down Deep Within the Cellar" and flatted six degrees. Old Grandpap Winter had us all dancing on the street corners, freezing our feet and roasting the street car service.

And just then, on February 2nd, when dancing had ceased to be an amusement, the Club's monthly dance arrived on schedule time. Consequently the attendance was not so large as usual, but all who braved six below enjoyed themselves thoroughly.

Chess

And now to end up with something quick and devilish we will just dash off the standing in the Works Championship Chess Tournament. This standing is only strictly accurate up to the date of going to press, but chess players move slowly, so perhaps it won't be far from accurate when the NEWS is distributed. Anyway, here is the whole horrible truth:

Name	Dept.	Games Won	Games Lost	Games Played	P.C.
F. P. Poole.....	6437	5	0	5	1.000
H. Hokenson	5058	5	0	5	1.000
J. M. Stahr.....	5055	4	0	4	1.000
J. Shallcross	6437	5	1	6	.833
C. Apsit	5771	3	1	4	.750
W. C. Spencer....	6965-A	3	1	4	.750
J. L. Harrington.	6961-A	2	3	5	.400
J. N. Selvig.....	6120-C	1	3	4	.250
H. A. Wankel....	6622	1	3	4	.250
O. Anderson	6422	1	3	4	.250
J. Friedl	6915	1	4	5	.200
C. F. Weselak....	6460	0	2	2	.000
B. A. Elliason....	7485	0	5	5	.000
I. W. McDowell..	6723-B	0	5	5	.000

AROUND THE CIRCUIT

GOSSIP GATHERED BY THE DISTRIBUTING HOUSE CORRESPONDENTS

New York

H. H. Gamble, Correspondent

BEFORE AND AFTER



H. H. Gamble

The new correspondent looked forward with great enthusiasm and relish to taking possession of the plush, padded chair of his predecessors, the former New York correspondents. It came as a shock and a surprise to find that the chair was only a hardwood, backless bench — lined not with plush, but bristling with cold, relentless tacks. Un-

daunted, however, he now sits therein by royal command, hoping for the help from New York contributors which his predecessors strove in vain to realize. His slogan is "If you don't help me, I'll do it all myself," for beginning with the February number, New York *must* be on the map — as follows:

BEFORE (The Feb. No.)

You had a lot of news,
Oh, why did you refuse
To send it in?

Of talent we have much,
With a delicatessen touch,
But you kept it in your clutch,
So naught came in.

AFTER (The Feb. No.)

When you have a bit of news
Or a joke that will amuse,
Just send it in.

Our talent is too bright
To hide its shining light,
So help with all your might,
And send it in.

The Company has redecorated the Sales Department, and polished its very fine, solid brass fixtures. Already the salesmen reflect this improvement—especially in their finish and brass.

"J. C. Maxon had a fit in a tailor shop."

It must have been serious, judging from that new speckled trout suit of his.

Did you ever try to call us on the telephone from an outside station? It's something like this:

"Hello! Give me Chelsea, one, triple ought."
"I beg your pardon?"
"Didn't you get it? One, zero, zero, zero, Chelsea."
"I don't understand you!"
"What? One thousand Chelsea. Ten hundred Chelsea."
"Now do you get it?"
"Oh, you mean Chelsea, one, ought, double ought. Why didn't you say so? Line's busy."

We notice in the February News that Chicago has a man—"Chesty Pritchard, with a forty-two inch, outward bound chest development, who is willing to meet any other 140-pound W. E. man in his specialty.

Before New York accepts this challenge, we would like to know under what atmospheric condition this test was made. If it was hot air, we will not challenge for the championship.

"Do you know our new manager, Leggett from San Francisco?"

"No, I didn't know that he did."

"Did? Did what?"

"Leg it from San Francisco."

To give an idea of the tremendous amount of business the New York house is doing, in the month of December, it handled approximately 9,000,000 lbs. of freight.

Did this include the coal sold to the telephone company?—Ed.

Kansas City

G. R. Ryder, Correspondent

We were visited early in February by the "FOUR STARS" from Broadway, and their Peerless Press Agent. After a two days' session, the question was put to the conferees to state what they considered was the most impressive feature brought out by the visitors from the East.

The reply was spontaneous and unanimous: "Templin's Pink Shirt."

We are still awaiting Mr. Thomson's decision on the wager made between our Stores Manager and Illuminating Specialist. The Stores Manager contended it was another of King's auto specialties, and immediately proceeded to issue special overstock bulletins on Klaxon Horns." The Illuminating Specialist insisted it was Tommy's advance copy of a full page spread of a Flood Lighting Campaign.

ELECTRIC BOWLING LEAGUE

	Won.	Lost.	P.C.
Western Electric Company	11	1	.917
General Electric Company	7	5	.583
K. C. Light & Power Company	5	7	.417
B-R Electric Tel. & Mfg. Company	1	11	.083

Western Electric Company Team Aver.

J. D. Todd, Manager.....	150
G. R. Ryder.....	175
J. Pebley.....	174
C. Swain.....	169
E. L. Spolander.....	162
John O'Gara.....	156
W. B. De Forest.....	142

On the strength of the above, our Advertising Manager, P. L. Thomson, permitted the team to wear bowling shirts, displaying the name "Western Electric." He stated that they come within that class, "QUALITY PRODUCTS."

Seattle

Jo Sorenson, Correspondent

All plans having been completed and contracts let, it is expected that our new home, to be located in the heart of the downtown business district, will be rapidly nearing completion by the time this issue of the News is distributed. The large, commodious office rooms which have been provided for, are so designed and arranged that visitors and customers can be taken care of with greatest ease. A great deal of attention has been given also to the arrangement of warehouse rooms and offices. A feature being the loading platform which is to be built back of the line of the building, thus enabling the truck drivers to load material without obstructing street traffic in any way.



Carrying Goods to Alaskan Ports Involves Ice Crustings Like This for Ships

Every Spring sees a quickening up of traffic along the water front due to the immense number of shipments going forward to Alaska. Large quantities of eatables of every kind, clothing, machinery and electrical supplies are purchased by numerous canneries, mining and fish companies, a large proportion of which have offices here. Owing to the great difficulties of transportation which some of these companies experience, material often does not reach its destination

until many weeks after the ship leaves the docks at Seattle.



How Western Electric Supplies from Seattle Sometimes Travel to Reach Our Alaskan Customers

Two of the accompanying photographs clearly picture situations with which most of us no doubt are unfamiliar. Often many feet of ice have to be removed from the decks of ships before Western Electric goods can be unloaded. In many instances, troubles have just begun when the shipment is unloaded at the docks of some far northern port. Where no railroads exist, and at most ports there are none, dog teams are employed to convey the precious cargoes over frozen fields and rivers to their destination. Our own products frequently travel this way.

Cleveland

W. H. Quirk, Correspondent

"TRY IT ANYHOW"

Did you ever know a batter who could out-guess every ball? Do you think the greatest mountain climber never had a fall? The only man who doesn't, is the one who doesn't try, He clings to little certainties and lets big chances lie. A perfect score means nothing in a game without a chance, If you will not take a gamble, and you won't lay down a bet, There is mighty little in this world that you will ever get. The "Fear to Try" battalion is a narrow coward crew, And they're never called "to fix it" when there's something big to do.

—G. E. Reardon.

Our bowling team is still well up in the telephone league. In fact the boys began to think they were "regular bowlers," so four of them entered a "head pin" contest conducted by the Cleveland Press, a few weeks ago. Our receiving clerk, who is a member of the team, was physically indisposed, and didn't try out the headpin game, but he did get some ideas that he worked into cartoon form. In fact the only reason we mention this headpin event is that we want to show off some of Stewart's handiwork.



HE'S A "LIVE" SALESMAN

The following appeared on City Salesman Parkinson's list of customers recently:

"Lakeview Cemetery."

Richmond

W. Lancaster, Correspondent

On January 15th, I. & G. N. car No. 3344 was loaded with 1917 year books at Hammond, Indiana, causing great rejoicing at Cincinnati, Richmond, Atlanta and New Orleans, who, having told their customers that they would certainly get their catalogs on time *this year*, felt that there was still a chance to get out with only a month's delay.

Now, in fairness to the Advertising Department we cannot say that the car hasn't been seen since. It has. In fact it has been seen twice. **TWICE IN THE SAME TRAIN!** You fellows that know more about railroading than you do about photography might not believe it, but it's a fact. See pages 20 and, 21, of the February 10th *Electrical Review*.

But it has never reached Cincinnati—its first scheduled stop—and all the customers in thirteen States are wondering, and half of them are asking what the "1917" means in connection with our latest year book.

All of which is responsible for the organization of "The Association for the Prevention of Carload Distribution of Catalogs."

The Charter members are the sales managers of the houses affected, and certain interested members of the advertising and traffic departments. The first meeting will be held on the day that the car reaches New Orleans, and the subject for discussion will be "If a year book is worth 51 cents on January 1st, what's it worth today?" With representatives of the houses composing a majority in the Association's membership the answer will probably be a journal bill against the advertising and traffic departments.

G. T. Marchmont.

RICHMOND'S MOVING DAY

The problem of moving from the old warehouse into the new was more difficult than that of just calling the dog. But organized under the leadership of W. H. Graham of the Chief Stores Manager's Staff, H. W. Hall, Manager, and "Bob" Montgomery, Stores Manager, the difficulties of its solution were transformed into a problem intensely interesting.

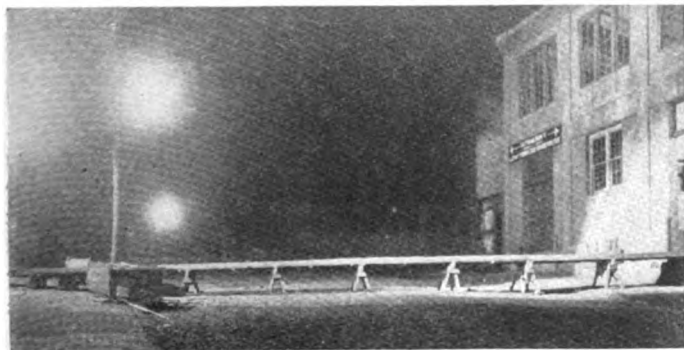

The Platform Runway Between the Two Warehouses—Our Old and Our New—at Richmond. This Platform Was of Immense Importance in Making the Transfer of Merchandise

The organization of labor was decidedly the most important factor to be considered. Western Electric employees were placed in supervisory positions, selection of stocks, assembling and final disposition. Following the

plan introduced in Boston, about eighty-five Richmond College students, members of football squads, track teams, and other athletic organizations were recruited to do the heavy work. Hand trucks and body trucks were used by them as skilfully as if they had been members in good standing of a longshoreman's union instead of Greek-letter fraternities.

Three shifts of eight hours were provided and two students managed the college boys and were responsible for producing them on time and in the number selected for each shift. These managers were paid on a basis contingent upon the number of men reporting and the number of hours each man worked. The men were paid on the hourly basis and a bonus for accomplishing the job in the specified time.

The newspapers of Richmond were alert in recognizing the news value of such a unique undertaking. The *News Leader* says that "within an hour after the boys were asked if they would undertake the job, fifty had volunteered. Seventy-five were used."

The *Times Dispatch* remarked: "Richmond was introduced to a new practice in moving last night when the Western Electric Company removed its stock to new quarters at the northwest corner of Sixth and Cary Streets, just across Cary Street from its old home. Elaborate arrangements had been made in advance of the undertaking, so that there should be the least interruption to business. Cary Street was closed to traffic, and a runway built from one building to the other, over which several hundred thousand pounds of electrical supplies were moved last night. * * * Strong electric lights had been placed on the outside of the building to light the runway."

An indication of the fit condition in which the workers finished is to be found in their demolishing the platform runway between the two buildings in a period of seven minutes, including storing the timbers in the basement of the new building. It took three carpenters more than seven hours to build the platform originally.

The entire job of moving was accomplished in five hours more than schedule—29 hours instead of 24 hours. The speed in the elevators in the old building was responsible for the error in the estimate, and the labor plan was in no way blameable.

The offices have also been moved. In the next issue of the NEWS will be found interior and exterior views of the completed warehouse.

St. Louis

A. C. Cornell, Correspondent

Referring to that rapidly-growing village, located on the banks of the Detroit River—its registered voting strength during the recent presidential election was 139,000, while that of St. Louis was 173,000. Although we admire the rapid strides Detroit is making in its growth, it will have to hustle to ever take from St. Louis its proud position as the fifth city. The foregoing figures do not bear out Detroit's claim put forth in the December issue of the NEWS.

In a recent contest held by the East St. Louis Light and Power Company of East St. Louis, Ill., in which a No. 1 Western Electric sewing machine was the prize, the following poem was declared the best of a large number submitted:

There is not the least reason or rhyme
 In the wisest excuse you may mention
 And I hope you will spare me the time
 And give me your closest attention:
 While as best as I can, although a mere man,
 Endeavor to tell what I mean;
 When I say you should buy for your wife 'ere you die
 A Western Electric Sewing Machine.

A touch of the toe, and swiftly I go
 Dancing away down the seam;
 No cramping of fingers, or backache now lingers
 For work is a sweet pleasant dream.
 No needles to thread, as the sewing is fed
 To my tireless and swift moving jaws,
 The shuttle is singing, the motor is ringing
 As onward the garment it draws.

Our mothers of old, with garments untold
 To cut, and to stitch and to sew,
 Toiled early and late, their burdens were great
 Such trouble you never need know—
 If you hasten in time after reading my rhyme,
 To the building where I may be seen;
 When my merits you try, I know you will buy
 A Western Electric Sewing Machine. —W. L. Dimock.



The picture shows our sales organization who were assembled during the annual sales conference. Unfortunately, this picture is not complete as F. W. Cherry, our telephone specialist, and J. P. Casey, of our city sales department, were not present at the time it was taken.

The names of these men shown are as follows, reading from left to right: Top row, R. G. McCurdy, T. K. Stevenson (Sales Manager), J. A. Baker, A. S. Dowell, E. H. Waddington, E. Lee Smith, A. B. Spicer, E. P. McGrath. Center row, A. C. Cornell, C. Goyert, H. L. Houchins, T. Leonard, H. A. Neher, G. L. Delany, E. S. Eisenberg, A. Peters. Bottom row, W. C. Morgan, C. E. Robertson, G. E. Cullinan (District Manager), H. Fritz, E. P. Betz, W. S. Barrett, W. J. Weinheimer and H. B. Davidson.

San Francisco

C. L. Huyck, Correspondent

Worthy descendants of Morgan's riflemen are the members of the Western Electric Rifle Club, of whom two-thirds of those who tried out recently qualified as marksmen under the severe tests of the U. S. Government. P. R. Bloden has been especially active in arousing and transmitting interest in the club.

There recently occurred the first of what the girls of the San Francisco House hope will be a series of luncheons. Not having celebrated the refurnishing of the lunch-room, nor having taken much time to become acquainted socially, it was thought appropriate to formulate a plan whereby such a celebration could be held—hence, the luncheon. The holiday season afforded ample suggestions for the decorative scheme which was carried out in red and white. Covers were laid for thirty-eight guests, and each of the six tables were tastily draped with red crepe paper and clusters of holly-berries. —E. G. S.

Chicago

R. F. Young, Correspondent

STRANGE

I read a great deal of *vers libre*,
 Which appears in the NEWS by the score;
 But never a line,
 Be it ever so fine,
 Is added to memory's store.

Though avid of Wolff or of Bateman,
 Though keen for the poems they write,
 If requested to quote
 Either luminous pote,
 I'd have to say "Pass!" or "Good Night!"

It may be that memory's so cluttered
 With sockets and fixtures and lamps,
 With motors and wires
 And cross-arms and pliers
 And cables and hangers and clamps.

The new stuff has no room to enter:
 The fault past denying is mine.
 Yet I still think it strange,
 As their poems I range,
 That I never remember a line.

—W. M. G.

The Clinton Street baseball team hereby challenges any other Western Electric Distributing house nine to a game or a series of games during the coming season.

P. S.—We haven't a baseball team, we never had one and don't expect to have one this year. We simply issue the above defy early in accordance with the custom observed annually by many Western Electric houses!

Just picture yourself as an agriculturist living within a radius of one hundred or two hundred miles of Chicago. You are sitting on your front porch some sultry afternoon next Summer, estimating the valuation of your potato crop based on retail prices on Chicago Avenue at 70 cents per peck.

Away down the road there is seen a dim and mist like puff of Illinois dust. It comes nearer and nearer and from its midst emerges a Ford runabout. From the front, there appears nothing unusual about this runabout. It looks just like thousands of other Flivvers that are stirring up the dust on country roads.

But you should see the rear. Oh, my! What is it? Your interest is aroused at once. The runabout halts before your front gate. The driver jumps out, jacks up the rear wheels, and, lo and behold, if there isn't a portable electric light plant all ready for action.



Ford Runabout with a No. 11 Farm Lighting Plant on the Back. To be Used in Demonstrating by Our Chicago House

The little runabout is from the Western Electric Company, Chicago. On the back of the machine is fastened a No. 11 Farm Lighting Plant with the generating apparatus in position so that it can be belted to a rear wheel of the automobile. The appurtenances to a complete lighting outfit such as sockets, wire, lamps and reflectors are also at hand. It is possible to give a complete demonstration of the outfit right on the spot before anyone that is interested.

We have our runabout all equipped and ready for action and await only the approach of more moderate weather to touch off our campaign.

SACRED TO THE MEMORY OF
 GEORGE B. PFEIFER
 SALESMAN
 HE WAS LATE

That the above inscription is not on a stone out at Woodlawn, now, is due to the fact that Mr. Pfeifer was lucky for once, at least. The prosaic little salutation of "Hello, George" is all, probably, that prevented a tragedy in the lobby of the Chicago house, recently.

Mr. Pfeifer was a half an hour late or so in getting down one morning. As to whether this was a usual or unusual occurrence, while it might be of interest to know, has no very important bearing on this story. Anyway, George was endeavoring to reduce his lateness by speedy foot-work between the elevated station and the office.

He arrived in front of our building just as a representative of the Brink's Express Company started to enter the door, carrying a cash box containing money for our week's payroll. George dashed madly after him through the swinging doors. He wanted to be sure and catch that elevator. The express company agent didn't know that, however. He saw George coming and thought that he was after the cash box.

The express company representative leaped through the door of the elevator, dropped the money box on the floor, and pulled his automatic cannon on the Western Electric salesman and was just about to open fire when "Bob" Anderson, the elevator man, who had observed the whole

performance and was all but speechless with horror, shouted out "Hello, George."

The Western Electric salesman then learned of his narrow escape. In relating the experience, a short time afterward, to a group of his associates on the eighth floor, one of his auditors, who did not seem to be impressed with the serious features of the story, suggested that "he didn't blame the expressman for mistaking George for a hold-up man."

Chicago Sales Dinner

The annual dinner of the Chicago House was celebrated on the evening of February 15th in the Gold Room of the Congress Hotel. There were 310 present, including approximately 100 customers. The occasion was the climax to the annual mid-winter sales conference. These dinners have been noted always for their originality, pep, humor, dash, interest, inspiration, vigor, decorum and good fellowship and the affair this year was a record-breaker.



VILLAGE REVIVAL SCENE

From left to right—Ferguson Fague, Edward O'Donnell, J. A. Saville, George Lounsbury and H. L. Grant

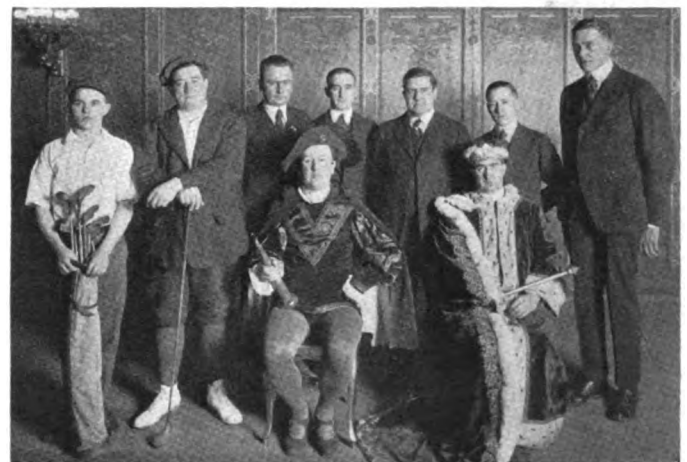

CAST OF JACK GLEASON'S ALL-STAR WESTERN ELECTRIC REVUE

From left to right, standing—Carl A. Geist, A. C. Poggi, A. B. Maynard, G. B. Pfeifer, J. H. Gleason, C. Curtis, Paul Des Jardien; seated—John Valenta, F. H. Van Gorder

In addition to congregational singing throughout the evening a number of stunts were put on. Jack Gleason's 1916 Western Electric Revue, produced in four short snappy acts, parodied local events. Mr. Ziegfeld would have been green with envy had he been there. Absolutely so. There was an Hawaiian band of local talent which dis-

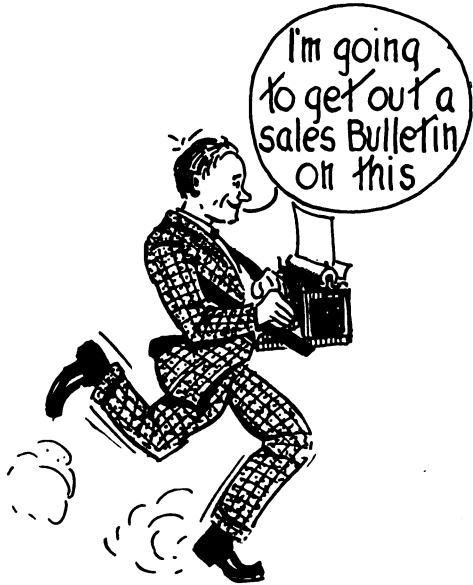

Willie Schmedler, Inventor of the Operating Ratio



Jack Sweeney, Who Looks and Acts Like Bob Fitzsimmons

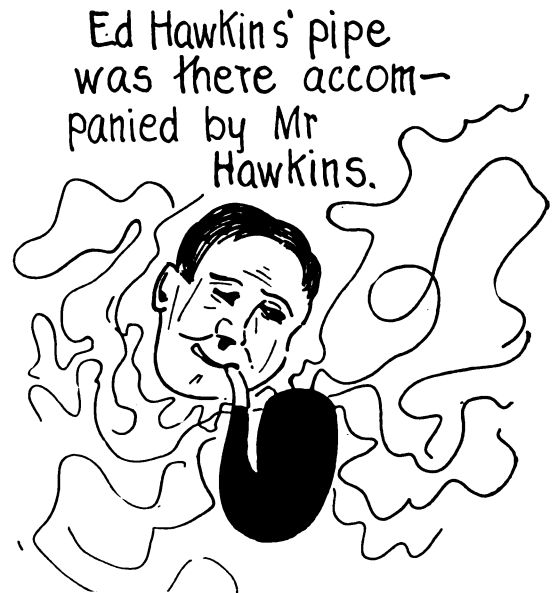

The Best Way We Could Think of Recording the Hawkins' Presence

coursed genuine Ukelele music and helped the guests to digest the generous offerings of smothered chicken, Risi, Bisi.

An effort was made to settle once and for all the question as to whether the Sales Department or the Stores Department is the more efficient. Battling Bill Thomas was selected to represent the Sales Department and Hustling Jerry Hogan, Stores Department. Judges were selected and Manager Ketcham appointed Timekeeper. Two desks with typewriters were in place on the platform, also two sets of packing box material, two hammers, excelsior, marking crayons, etc. At the back of the stage there was a stock bin containing 12 kinds of merchandise in sufficient quantities.

The contest was started by giving Hogan and Thomas each identical copies of customers' order. They then performed all the operations of the house—red-tagged the order, called frantically to the audience for credit men for approval, edited the order, wrote it up on the typewriter, rushed to the stock bin, selected the material, made a packing box, slammed the material in (breaking it liberally), nailed up the packing box, addressed the package and came out at exactly the same moment. Elapsed time,



WESTERN ELECTRIC HAWAIIAN OCTETTE

From left to right—C. Curtis, Paul Des Jardien, A. R. Maynard, D. T. Laylin, J. H. Gleason, G. B. Pfeifer, A. M. Collins, C. H. Scribner

according to Timekeeper Ketcham's watch, 2 minutes and 54 seconds. The judges voted the contest a draw.

Following this was given a Village Revival scene. The characters in this are shown in the picture.

At 9:30 Mr. Durgin, of the Commonwealth Edison



Exhibit of Western Electric Products by Our Agents, the Central Chandelier Co., at the Iowa Electrical Contractors' Assn. Convention Held Recently at Cedar Rapids, Iowa

Company, commenced his address on the subject "Modern Lighting." Mr. Durgin illustrates his points with numerous experiments in physics and lighting. He has an elaborate setup including two miniature stages on which identical objects may be illuminated under different conditions. He closed his address by illustrating on these two stages a typical living room under daylight conditions, under ordinary night lighting and under the improved night lighting which is readily available today. Mr. Durgin's lecture furnished a most interesting and profitable finish to the evening's entertainment.

Oh, yes. Sales Manager H. L. Grant was Master-of-Ceremonies in his own, inimitable manner.



Chicago's New \$4,000,000 Municipal Pier Which is to be Lighted by Western Electric Sunbeam Mazda Lamps

On January 17th, Honorable Wm. Hale Thompson, Mayor, awarded to the Chicago house of the Western Electric Company the City of Chicago's contract covering incandescent lamps for the year 1917. This contract was placed on the \$100,000 basis and provides that Western Electric Sunbeam Mazda lamps will illuminate Chicago street, the City Hall, the numerous municipal parks and bathing beaches, the various municipal sanitariums, libraries, numerous schools and the new Municipal Pier.

The City of Chicago was the pioneer in the adoption of Mazda C lamps for street lighting and now has in use over 15,000,600 C.P., 20 amp., Mazda C lamps. In the near future the city is preparing to displace 10,000 flaming arc lamps and use instead modern Mazda C lamps.

Mayor Thompson is backing a progressive campaign of

city improvements and among other things he plans to make Chicago the best lighted municipality in the world.

Boston

D. A. Chase, Correspondent

During a recent fire in one of the hotels in New England, the Western Electric Annunciator Telephone Sys-

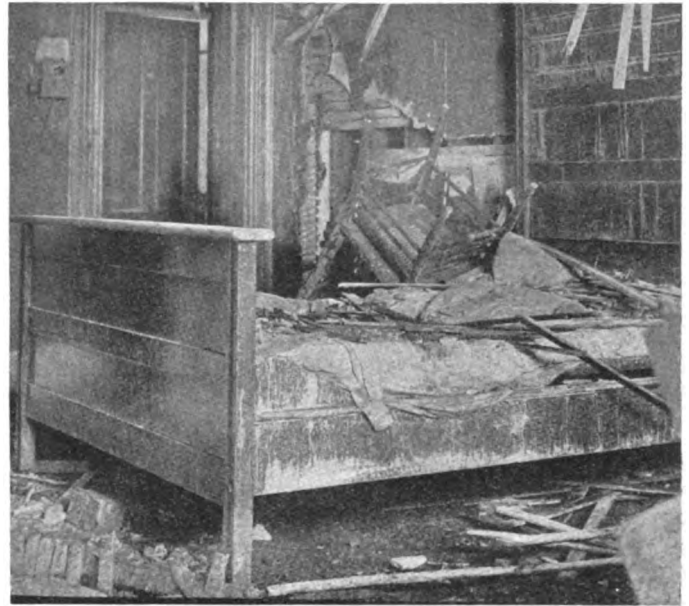

tem was used to awaken the guests and warn them to leave the building. Several lives were saved thereby. The photograph shows one of the rooms with the No. 1327 Interphone still operative.

Pittsburgh

I. B. Stafford, Correspondent

The Western Electric Railroad Catalog of telephone and selective apparatus looked so good to our mailing department that when received by our mailing room it was routed around the office as a magazine. It ended up in the display room.

We will agree that it is classy enough to be put on exhibition, and think that our mailing room ought to be complimented on their good judgment.

One of our inside specialists recently requested our auto truck or wagon to make a special delivery. He was told that it could not be done as the destination was off



Another View of Chicago's \$4,000,000 Pier. It Extends Three-Quarters of a Mile Straight Out Into Lake Michigan. This Will Soon Gleam with Western Electric Sunbeam Mazda Lamps

the car line. The answer at once came back, "What's the car line got to do with it? Has our auto got flanged wheels?" He carried his point.

W. T. (Wash) Haynie, the washing machine expert of the General Department, was in our territory recently, and on a visit to Wheeling with one of our men was informed that the Greek proprietor of a small restaurant was in the market for a dish washer. Haynie and our

salesman called on the restaurant man. Haynie opened the ball by saying, "I hear you need a dish washer."

"Yes, I do," said the Greek. "How much wages do you want?"

There certainly is proper co-operation between our Credit and Sales Departments. The other day our new salesman, Reed, when bringing in his first order, brought along a check in full payment! He has promised the same co-operation upon any other orders that he may be fortunate enough to receive.



NEWS FROM HEADQUARTERS

Some Items of Interest from the General Departments



General Sales Department

W. A. Wolf, Correspondent

Dear Birthday Child:

If we're correct, you celebrate your natal day this first of March and may suspect a greeting to be on its way. Quite right, you are, precocious child, when one has reached the age of five and good Dame Fortune on you smiled, congratulations should arrive.

Of course, we don't see much of you, just once a month, but we'll be bound you're welcome has a ring that's true whenever that time comes around. The reason? That's not far to seek. It's simply this and nothing more. In you our far-off brethren speak and never have you been a bore.

With great delight we've watched you grow into the dandy lad you are. Your early struggles, too, we know. Your stock with us is up at par. So, keep on growing year by year, a bigger, better youth all through.

Accept this as our wish sincere.

Yours, W. A. W.

AN OPEN LETTER TO JOHN SHAY, CHIEF MOVER

When we were quite young we went to a co-educational public school and didn't like it. Maybe our age had something to do with it, and then girls have such a multitude of ways of making a fellow feel like two cents.

Now, our lockers have been moved to the same neck of the woods where the fair damsels hang their wraps.

We are long past the age where we abominated girls and we now frankly enjoy gazing upon them. We actually do.

But its awfully embarrassing to wade through a bevy of chattering, be-flounced and be-frilled girls to get to our duds.

Girls have such a lot of funny places in which to keep their powder puffs.

COMING BACK STRONG

Wrote the secretary of the Klaxon Company to E. J. Riley after having missed seeing E. J. at the Auto Show:

"However, you seemed to disappear for when I looked around after speaking to you a minute before you were gone.

"I did not know the Western Electric Company handled

electric wings. If you do, put me down for a pair, for I can use them very readily."

Silas Green Breaks Into Verse Again

WHOO! POLE CORNERS

Dere Editor

Our light plant cum en we putt it een
 It's the finest thing I ever seen
 We lit the house en yard en barn
 No more gloomy evenins on our farm
 Ever sense we got our W. E. Light
 Nay burs cumin to see us every night
 Cynthia plaze the organ en Bob the drum
 Ma she sings while I set en hum
 Folks all feelin reel pert en glad
 Pere kinder proud o their ole dad
 I kragt a joke at Bob's expense
 En I been laffin ever sense
 I sed—"You know?" kinder larkin,
 "That Dinyoze like you—sometimes sparkin."

* * * * *

We got the thing for the joy en fun
 Not fer jest what et wood run
 But, by Heck, it are a sin tew snakes
 What a savin it sure makes
 Washin, ironin and by durn
 How it galivants that ole churn
 Pump water fer the stock? Well yew bet!
 Very first mornin while we et,
 Cum out en see us en our masheen
 Hopin yew are the saime, Yours,
 Si-Less Green.

General Merchandise Department

J. H. Hellweg, Correspondent

"It is painful to refer to previous correspondence on No. 190 jacks, but we again have to extend our promise, etc., etc.," reads a recent memorandum from the Shop Output Department. Not wishing anybody any harm, we hope the pain increases until relief is found.

"Yes, you may see Mr. Hellweg now. He is vacant," said Ted to the visitor who expressed a wish to get into the front office.

Western Electric News

PUBLISHED MONTHLY FOR THE EMPLOYEES

BY THE WESTERN ELECTRIC COMPANY, INCORPORATED

H. B. Thayer, <i>President</i>	H. A. Halligan, <i>Vice-President</i>
W. P. Sidley, <i>Vice-President and General Counsel</i>	A. L. Salt, <i>Vice-President and Gen. Purchasing Agt.</i>
Gerard Swope, <i>Vice-President and General Sales Manager</i>	H. F. Albright, <i>General Superintendent</i>
J. W. Johnston, <i>Treasurer</i>	F. B. Jewett, <i>Chief Engineer</i>
G. C. Pratt, <i>Secretary</i>	R. H. Gregory, <i>Comptroller</i>
C. E. Scribner, <i>Consulting Engineer</i>	

Office of publication and address of President, Secretary, and Treasurer, 195 Broadway, New York City.

BOARD OF EDITORS

P. L. Thomson, <i>Editor-in-Chief</i>		
P. K. Condict	E. C. Estep	S. W. Murkland
W. F. Hendry	P. J. Holdsworth	H. D. Agnew
John Colter	Reed Calvin	

Subscription: \$1.50 per year, except to employees of the Western Electric Company, to whom copies are furnished free of charge.

All communications and contributions should be addressed to WESTERN ELECTRIC NEWS, 195 BROADWAY, NEW YORK.

Matter intended for any given issue must reach New York not later than the 12th of the preceding month.

VOLUME VI MARCH, 1917 NUMBER 1.

THE News is constantly striving to produce a magazine more interesting and helpful to its readers. This month one of the usual features presumed to be of interest to all has been omitted.

The Editors are curious to know whether or not you miss it. If you do, and think that the absence of this feature detracts from the value of the magazine, let us have the benefit of your opinion.

Changes in Organization

C. H. TALMAGE has been appointed Manager at Salt Lake City. H. L. Harper has succeeded Mr. Talmage as Sales Manager at Kansas City.

T. E. Burger has been appointed Assistant Sales Manager at San Francisco. D. J. Butts succeeds Mr. Burger as Manager at Los Angeles.

C. W. Chestnut has been appointed Sales Manager at Seattle. A. H. Bannister succeeds Mr. Chestnut as Sales Manager at Omaha.

Charles W. Chestnut came with the Western Electric Company in 1907, and spent the first few years in Telephone Sales Work on the road, with headquarters at Omaha, later at Des Moines. In 1911 he represented the Power Apparatus Sales Department in Omaha, and, in October, 1914, became Sales Manager at Omaha. Mr. Chestnut is due to receive his Service Badge this coming May.

D. Jay Butts has been with the Western Electric Company since June 20th, 1903, when he entered the Armature Winding Department at Chicago. In the Drafting Department at Hawthorne in 1905, in Construction work

in New York in 1906, and later in Power Apparatus Sales work at New York and Boston. Mr. Butts, in 1916, was assigned to Specialty work at Salt Lake City, becoming Manager there last May.

In 1906 Theodore E. Burger was a salesman in the California Electric Company, Los Angeles, and, two years later became Assistant Manager of the Western Electric Company's Los Angeles house. In 1909 he became Manager.



C. W. Chestnut



T. E. Burger

The Shipping Department at Kansas City in 1903 was the starting point of Harry L. Harper's Western Electric career. Since then, he has served successively in the Stock and in the Credit Departments. In 1907 he was assigned to Telephone Sales work at Kansas City. In 1913 he was in Telephone Sales work in Dallas, and, upon his present appointment to Sales Manager at Kansas City, returns to that city a little over fourteen years after the date of his entrance to the Company.

Charles H. Talmage, who became Manager at Salt Lake City on February 19th, started in the Western Electric Company as Road Salesman at Chicago sixteen years ago. He later became House Salesman at Chicago and at Kansas City, and, in 1906 Sales Manager at Kansas City.



D. J. Butts



C. H. Talmage

Alfred H. Bannister has been for eleven years a Western Electric Man. Beginning in the Installation Department, November, 1906, he became Installation Foreman at Chicago three years later, efficiency engineer in the Installation Department in 1911, Salesman at Minneapolis a few months later; and, in August, 1913, became Telephone Specialist at Omaha. Mr. Bannister takes up his work as Sales Manager at Omaha, March 1st.

AMONG THE ENGINEERS

NEWS OF THE DEPARTMENT FROM NEW YORK AND HAWTHORNE

New York

K. Bungerz, Correspondent

On January 15th the administration of the West Street Building was transferred from the New York Local House to the Engineering Department. The former had been in charge since the removal of the Manufacturing Department to Hawthorne in the Fall of 1913. As a result of the change, the Engineering Department has taken over the Building and Maintenance Branch, the Medical Division and the Employment Division. The last two mentioned, report to F. L. Gilman; the Building and Maintenance to W. F. Hendry, Old Simon Legree Bill of fond memories, who, when superintendent of the old New York shop, made us all feel that B. & M. stood for benevolence and modesty.

Owing to the expansion of engineering work at New York, it has been necessary to acquire more space. Nearly one-half of the building is now occupied by the Engineering Department for offices and laboratories. To the Chemical Laboratory has been assigned the space on the 13th floor vacated by the Comptroller's Department on their removal to 195 Broadway. Thus the whole of the 13th floor is now devoted to chemical research and analysis work. The 12th floor offices, formerly used by the officials of the Company, are occupied by the executive offices of the Engineering Department. In addition the historical museum and part of the clerical force are also located on this floor. The 11th floor, with the exception of a small portion, is occupied by the Administration and Sales organizations of the local house. Most of the space on the 7th, 8th, 9th and 10th floors is used as laboratories and offices for the department. Scattered throughout the

building on the other floors are sections devoted to the same purposes.

A detailed description of the new Laboratories will be published when they are completed and photographs can be taken. The foregoing should convince Branch Houses outside of New York that mail addressed to 463 West Street will still reach the Engineering Department.

In a list of "D" Case subjects we ran across the following: "D. C. Adjuster for Biasing Springs of Sub-Station Belles." Anyone who lives on a party line with them knows that no adjuster is necessary. They work on the slightest provocation, and won't shut up no matter what measure of insult is heaped upon them.

A HORSE TALE

Why anybody who dabbles in such high brow stuff as wireless telephony should concern himself with that archaic contraption, the horse, is more than we can understand. Perhaps it is merely another manifestation of the fact that high brows and hofbraus have one thing in common. They are both more or less human. One noon time a particularly wise wisecracker was walking across 14th Street in search of a meal. On his way he was intercepted by a gentleman of color and importuned to divest himself of \$10.00 for the purchase of a pawn ticket held by said African.

Now \$10.00 is an awful crime with which to charge an engineer. Much talk ensued, and the fact was brought out that the Ethiopian wanted some money to wager on a "sure thing." He was so convincing in his tale that at last the engineer loosened up on a nickel to call up the

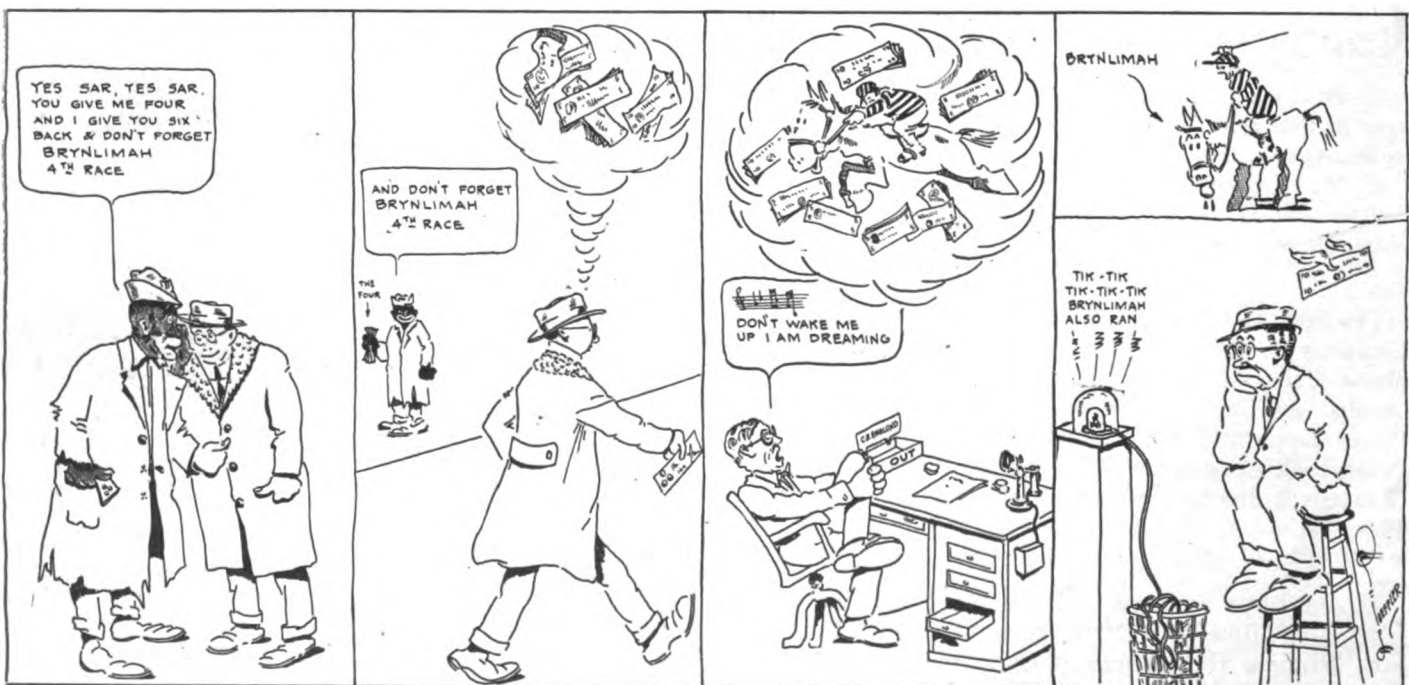

Paynshop to see if the ticket was good. On finding out that it was, he advanced all the money he had, \$4.00, and received for it the ticket good for \$60.00 worth of diamond ring. Of course, the four bones were only a loan. They were to be repaid the next day plus a liberal bonus. (The bonus must have got him). Thereupon the smoke departed and left the engineer to gloat over his great gain and, incidentally, to continue the search for a meal.

For an obvious reason, the pawn ticket, the meal did not materialize. However, he had become so impressed with the negro's enthusiasm that he decided to lay a little wager himself on the "nag." Now this part of the story, of course, should not be told. He returned to the Office, told his tale and borrowed a dollar. Soon he had four fellow high brows interested to the extent that they too coughed up \$1.00 each and laid it on the horse. The skate could not lose, that was a foregone conclusion—the dinge had vouched for that; he confessed to being a good judge of horse flesh. All was hope until the report of the race came in. The critter had run, also he had finished—last.

Of course, when the victim raises the sixty bones, plus about five years' interest, he can get the ring.

Reed Calvin is an interesting writer on lots of subjects, even though he does try to tell us that transmitter mouthpieces are made of rubber without qualifying his statements and telling us which mouthpieces are which, but when he tries to slip one over on the Engineering Department he treads on dangerous ground. We present herewith a reproduction of the original of that Crafty telegram to which reference was made in the Hawthorne section of last month's News. Sorry we have to spoil a good joke, but then we can't help it that the telegraph operator

top of this at a point near where this spring to be the same as the split recess for holding the fuse clamping spring please discuss with we can get the governments approval craft

caught only enough clicks of the sounder to make the letter "y" instead of the usual symbol for the end of a message.

What's the use! We waged a relentless campaign against the whistle nuisance, and at last succeeded in getting an organ-toned affair to replace the old one. As soon as the change had been made we decided to see how many people appreciated it. About 99% of those interviewed had to admit that they hadn't even noticed any difference.

ENGINEERING MEETINGS

The following papers were read at regular Friday night meetings:
 Jan. 19th. F. J. Holmes—The Engineering Value of Historical Records.
 Feb. 2nd. G. Dobson—Magnet Windings.
 Feb. 16th. A. Akin—Relays and Their Development.
 In the elementary series the following papers were read:
 Jan. 26th. S. S. A. Watkins—The Oscillograph and Some of Its Simpler Uses.
 Feb. 2nd. R. T. Staples—The Simpler Electrical Measuring Instrument.

Hawthorne

W. E. Viol, Correspondent

ENGINEERING DEPARTMENT'S BANQUET

The annual banquet of the engineering departments, held at the Fort Dearborn Hotel on January 17th, was the largest and most successful affair of the kind ever sponsored by the Hawthorne branch of the department.

One hundred and ninety members of the organization, each with a ticket safely stowed away in his vest pocket, took the air-line route to the loop that evening, all set for a big night.

The evening started off with a bang and a man-size dinner, after which the banqueters were entertained by numerous witty wheezes exhaled by various members of the department. C. A. Berry, of the A. T. & T. Co., and Otto Pruessman also "wheezed."

Later in the evening a bunch of entertainers took possession of the stage and kept the crowd laughing until time to go home.

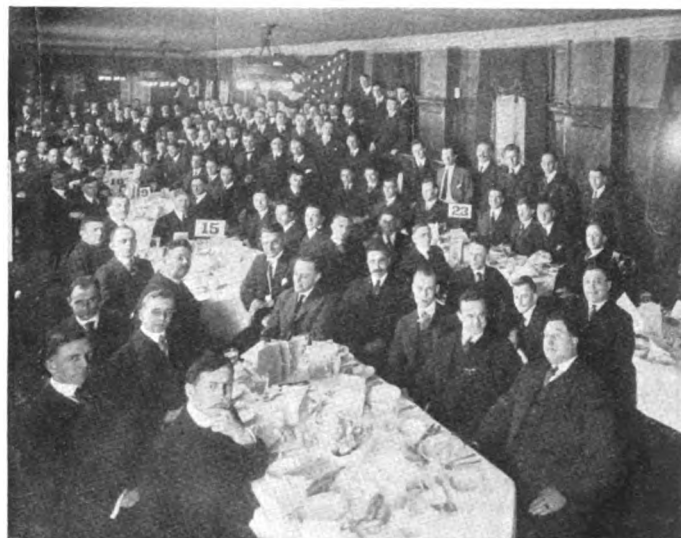

Engineers and Eats Get Together at the Second Annual Banquet of the Hawthorne Equipment Branch

Foremen's Clerks' Banquet

D ID you say fun? Did some one say TENDERLOIN A LA MORAVEC? Well, now, just listen to this: The other night—to be exact, Saturday, January 20, 1917—over 100 members of the foremen's clerks' department gathered at the Fort Dearborn Hotel and took part in what has since been called "The-Best-Time-I-Ever-Had" banquet.



Look at the picture. Do we look down-hearted? The fun started the minute the doors were opened and continued until the last refreshments had been stored away. Members who were not acquainted soon found themselves clicking steins and exchanging confidences while enjoying the tunes furnished by our royal entertainers, Messrs. Daw and Russell. Although this is the first gathering of the foremen's clerks for several years, judging from the hilarity and good feeling shown, it looks like the fore-runner of many to follow. *F. L. Z.*



The Equipment Drafting Department Caught in the Act of Relaxing

All Join in the Air

IT is noticeable that the "fresh air fiend" usually sits in the center of the room, where the freshness doesn't hit the back of his neck and set all the little influenza bugs to work. As the man next to the window occupies the strategic position in a ventilation controversy, the result usually is that a large office room gets decidedly "stuffy" in cold weather.

To remedy this condition, an instruction recently went into force at Hawthorne, providing a morning and an afternoon recess of five minutes each, during which the office windows are opened for thorough ventilation. At first the occupants of the rooms used merely to get up and walk about while thus taking the air. Then some of the equipment draftsmen improved on this practice by starting a little class in physical culture. Soon the whole department, joined in; then another and another department, until now, as our cartoonist heads his illustration, "Everybody's doing it," following volunteer leaders, who get up on a desk or a drafting table and set the pace.

Unfortunately, the News is not a moving picture magazine, so we can't show a group in motion, but we are doing the best we can by giving a photograph of the equipment drafting department and a cartoon by a member of the apparatus drafting department.



Our Calisthenics Prof.! Everybody's Doing It

Do You Always Feel Properly Grateful When—

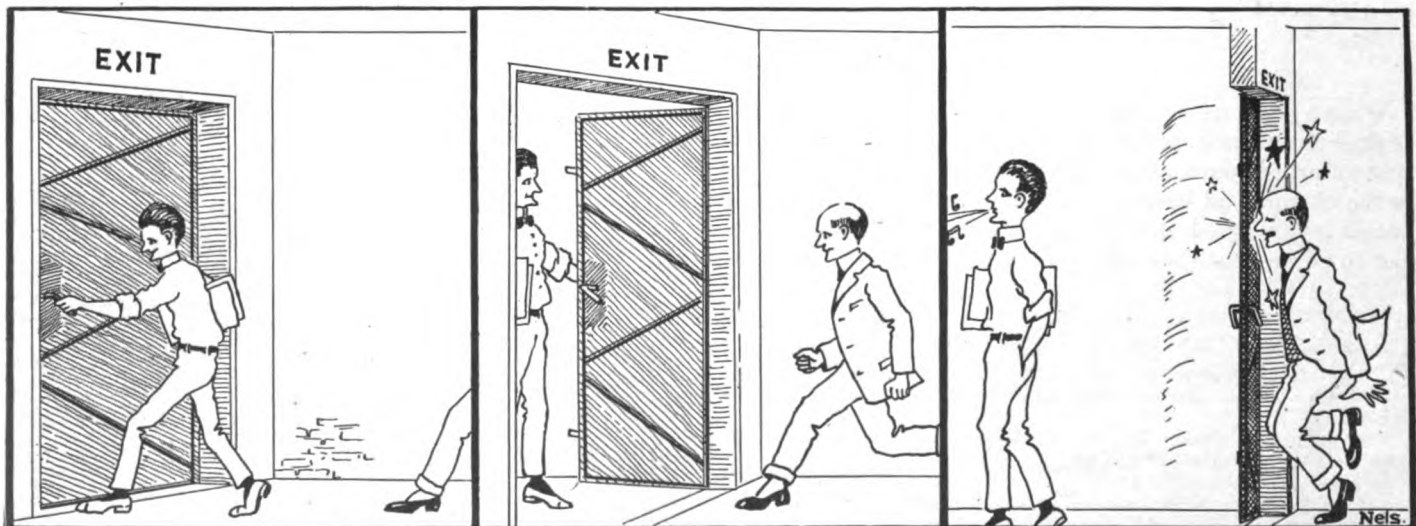

The Polite Fellow Ahead Swings Open the Heavy Steel Fire-door—

And Holds It Open for You; and Then Just Before You Reach It—

Decides That He's in Too Much of a Hurry to Wait Any Longer?

HEARD IN THE SHOPS

ACTIVITIES OF THE MANUFACTURING DEPARTMENT AT HAWTHORNE

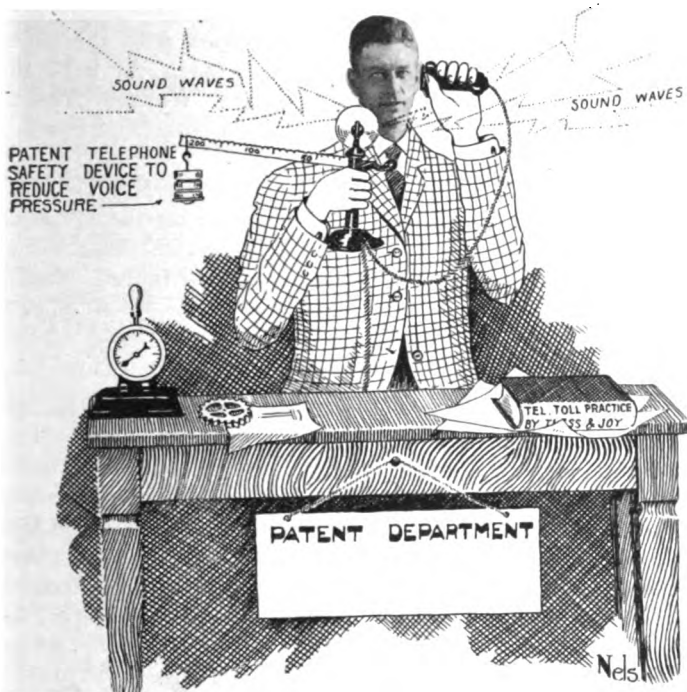

Who's Who at Hawthorne

Who, when we'd patent our advice to stop cross-talk in 'phones, says: "Nix. The scheme is very nice but old, I'll bet three bones?" Who then brings records to the front and proves beyond a doubt that Adam used the self-same stunt when cross Eve bawled him out? Who, ere he took up legal lore, once filled a book, with Joy? (Cap J, proof-reader, or your gore! It's some one's name, old boy.) Who drives an 80 horse-power voice, lit with a Mazda grin, that says: "Get busy, there. Rejoice!"? Right! Barney Thiess. You win.

"Cap" Merrick Goes to See

C. S. Merrick, who heads the stock division of the general merchandise department, always carries on hand a large stock of patriotism. Even compared to Nathan Hale or Ed Herbert or any of those real fellows, "Cap" is a patriot of no mean dimensions. In fact, all of Cap's dimensions are extreme (although, since arithmetics claim that the product of the means equals the product of the extremes in proportions, it appears to boil down to the same thing, anyway). But be that as it may, what we're trying to get around to is that "Cap's" patriotism and his extreme dimensions are expensive luxuries.

It seems that he and Fred Holdsworth went daown tew the city t'other day on business. It was "Cap's" first visit to New York and he had made up his mind to see two things before he left. One was Grant's monument and the other was the chicken show at the Winter Garden.

Pursuant to the first of these objects "Cap" took a quarter and a rubberneck 'bus and sallied forth on his

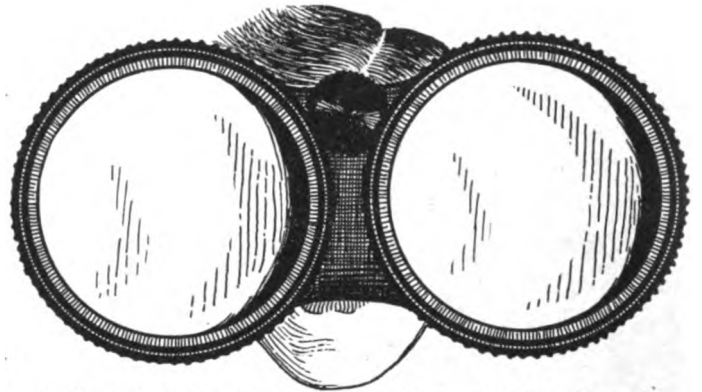

C. S. Merrick at the Winter Garden Show. "Cap" is Certainly a Good Looker

patriotic pilgrimage. Now, Merrick's head is far enough from the ground when he is walking, but when he was perched away up on that Seeing N' York wagon it protruded so far above the tops of the high buildings that he overlooked the monument entirely. After three trips around the 'bus route he finally returned to the hotel in disgust. "Gosh," he said to Holdsworth, "what do they do with their blamed monuments here, anyway—take 'em in so they won't get cold in the winter? Guess I'm stung 75 cents' worth."

And "Cap" hasn't been told yet that he took the wrong 'bus line. But he didn't overlook anything at the Winter Garden.

Tool Draftsmen's Banquet

No photograph was furnished for publication in connection with the write-up of the tool draftmen's banquet at the Planters' Hotel, February 7th. Our informant remarked that if the description did the affair justice, the text would be sufficient without any illustrations. However, all we saw was the menu (and that looked good) and the program (and that looked good) and the boys the next day (and they didn't look so blamed bad, at that). So the best we can do is pass along their assurances that it was the jolliest event ever held in Chicago, and let them scrap it out with other banqueters making similar claims.

Planning Boards Boys Bowl Boldly

Two teams of bold bowlers from the planning boards sections met at the Vermont alleys, January 27th, to settle a little argument. Jack Urbane's crew bowled enough louder than George Doss' men to win the dispute by 79 points. The official report follows:

Name	1st	2nd	3rd	Aver.	Name	1st	2nd	3rd	Aver.
Monahan	168	170	171	169%	Quinn	107	104	83	98
Urbane	83	100	107	96%	Linden	109	137	96	114
Ford	166	154	166	162	Reinhart	120	170	130	140
Munro	80	102	127	103	Doss	114	146	121	127
Duhey	107	109	86	100%	Doskicil	137	129	114	126%
Totals	604	635	657	632	Totals	587	686	544	605%
Total for 3 games.	1896				Total for 3 games.	1817			
Official Scorer, Kolsky.					Official Foul Man, Civick.				

Second Annual Dinner and Bowling Party of the Inspection Department

ON Friday evening, February 9th, the Inspection Department held its second annual dinner and bowling party. About ninety inspectors gathered at Wiechmann & Gellert's restaurant at 7:00 P. M. for the start of the program—the big feed. The next two hours were given over to a general jolli-

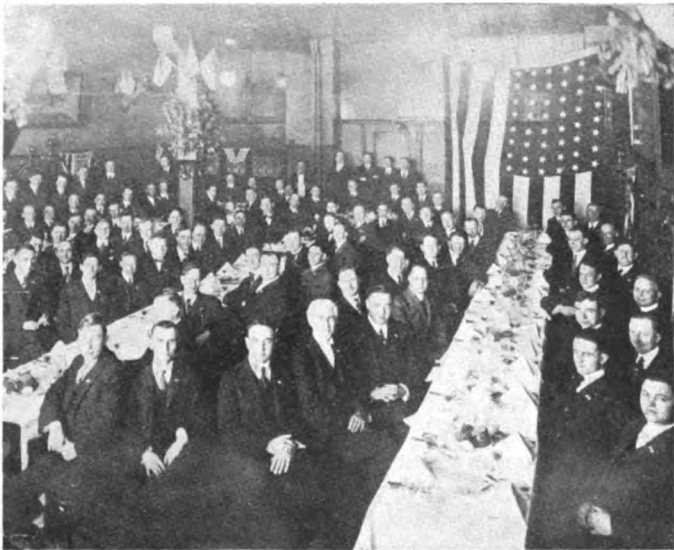

fication. The crowd enjoyed the dinner, sang themselves hoarse, listened to some of Frank Sheridan's new (?) stories, and appreciated a forecast by Superintendent of Inspection Hoban of the work to be done during the coming year.

Messrs. Corris, O'Neil and Shean entertained by singing numerous songs. Mr. Corris, to the great enjoyment of all, rendered that painful little ditty, entitled "Tom Reilly's An Old Man Now."

Mr. Lewis at the piano and Mr. Vodak with the violin also furnished some very pleasing music. At 9:15 the whole crew adjourned to Bensinger's Wabash Avenue House, where ten pocket-billiard tables and nine bowling alleys had been reserved.

It would take too long to tell you how Big Bill Teichtler hit his stride and cleaned up the bosses on the alleys or how the worm turned and gave R. J. Reid, inspector of raw materials, an awful drubbing on the tables. Suffice it to say that everybody had a good time. *K. E. S.*

We "Point With Pride"

It is encouraging to see how much care moving picture producers are using nowadays with their "settings." One of the scenes in "Pride" shows a lineman at work on a telephone pole, and the most prominent thing on the screen is a Western Electric cable reel. There is at least one film-director who knows it doesn't look like a real job unless Western Electric apparatus goes into it. *Pride* is right!

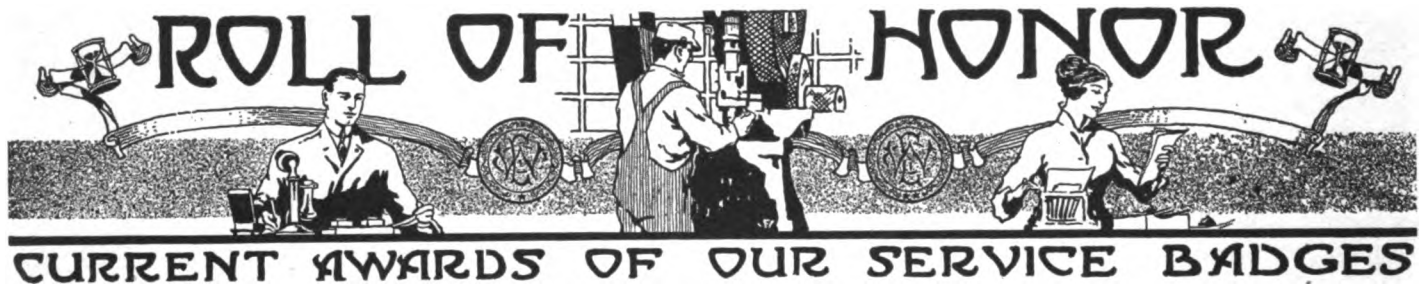

To Be Awarded In March

THIRTY-YEAR CLASS	
Marcy, E. D., Hawthorne.....	March 20
TWENTY-FIVE-YEAR CLASS	
Albright, H. F., Hawthorne.....	March 1
Lyon, J. B., Hawthorne.....	March 1
Plamondon, E. K., Hawthorne.....	March 26
Quigley, M. J., Hawthorne.....	March 31
Barbieri, L., New York.....	March 1
Forsberg, C. E., New York.....	March 1
Hallock, F. E., New York.....	March 1
TWENTY-YEAR CLASS	
Nielsen, A. B., Hawthorne.....	March 9
FIFTEEN-YEAR CLASS	
Van Ranst, E., Hawthorne.....	March 1
St. George, J., Hawthorne.....	March 3
Sweeney, J. F., Hawthorne.....	March 8
Decker, C., Hawthorne.....	March 11
Valchar, J., Hawthorne.....	March 12
Schoenwald, A., Hawthorne.....	March 19
Linsey, P., Hawthorne.....	March 25
Oktavec, A., Hawthorne.....	March 26
Bresemann, F., Hawthorne.....	March 27
Philler, H. L., Hawthorne.....	March 27
Winter, W. S., Hawthorne.....	March 27
White, J. E., Hawthorne.....	March 29
Warner, F. M., Hawthorne.....	March 31
Clarkin, T., New York.....	March 13

Wilson, Nellie V., New York.....	March 28
Dehner, C., New York.....	March 28
Powell, Chas. H., Philadelphia.....	March 20
TEN-YEAR CLASS	
Schmidt, A. C., Chicago.....	March 2
Janes, Robt. B., Chicago.....	March 12
Hill, H. J., Hawthorne.....	March 6
Dolan, C. M., Hawthorne.....	March 11
Gorski, J. F., Hawthorne.....	March 14
Dvorak, E., Hawthorne.....	March 16
Selig, W., Hawthorne.....	March 18
Swenson, F., Hawthorne.....	March 30
Staples, R. T., New York.....	March 19
DeVignier, R. M., New York.....	March 8
Firman, Walter C., Philadelphia.....	March 4
Peters, Arthur, St. Louis.....	March 12



E. D. Marcy



J. B. Lyon



E. K. Plamondon



E. Van Ranst



Luigi Barbieri



H. F. Albright



F. E. Hallock



C. E. Forsberg



M. J. Quigley

Sweet sounds used to issue from old Section C, Clinton Street, after working hours in the early days. They were made by the first Western Electric Band, practically after working hours. One of its members was E. D. Marcy, solo alto player. Ed no longer plays alto, but he is still with the company after 30 years' service. His present position is in the building department. If there is anything in heredity, Ed should be good for several more stars. His mother died a year or two ago at the age of 100 years.

Before 1892, transmitter buttons made in our New York factory were furnished at the A. T. & T. shops in Boston, where the grinding and gauging were done. J. B. Lyon's first work with the company was transferring these finishing operations to our shops. His next job was on central office equipment, not including switchboards. He was a sort of combination engineering and output department, and did everything from issuing orders to chasing. Piece-work rates was his next venture, and apparently was his forte, for his present position is head of the piece-work rates' department at Hawthorne. "Pop" can guess off-hand almost exactly what the work on any new part will cost from his knowledge of the cost of making similar parts.

The Western Electric exhibit at the Chicago World's Fair in 1893 was an electrical marvel for those times. It opened with a landscape scene, showing the sun rising. Later a storm came up (featuring our factory-made lightning), which was followed by a beautiful rainbow. E. K. Plamondon, now locksmith in the Building Department, knows a lot about that rainbow. It was made by atomizing a jet of water with air from a blower, while a "rainbow" from a special mirror was thrown upon the spray. When the stunt was first tried out at the factory Ed. had the job of supplying the water with a dipper. Any man who has made rainbows can easily carry stars, and the new button that Mr. Plamondon gets this month will have three on it. At the time he made rainbows—and, indeed, until he was transferred to his present department in 1909—Ed. was working in the Millwright Department.

Twenty-five years ago the Company secured the services of a young Pittsburgh engineer, who was hired as an electric lighting and power apparatus salesman, principally on the recommendation of a Western Electric salesman, who had competed with him in an endeavor to get a city lighting contract. Evidently he had made things fairly interesting for his rivals. He continued to do so as a Western Electric salesman until he was made plant en-

gineer at New York in 1898. His work in this position was so satisfactory that he was soon given charge of the New York factory. Later, in 1908, he was transferred to Hawthorne as General Superintendent. This in brief is H. F. Albright's history with the Western Electric Company. Mr. Albright gets his three-star service button the first of this month.

From packer of sub-sets to general foreman is quite a long trip to make even in 25 years' time, but M. J. Quigley can fasten on his 3-star button this month with the satisfaction of having made it successfully. Mike went from the packing job into the switchboard wiring department and later made good on the road as an installer. In 1899, he again returned to the shops and shortly after he was made foreman of the switchboard wiring department and later general foreman over the wiring and cabling department, his present position.

One of those people bound to be in at the finish is E. Van Ranst. He started in the wood finishing department, worked in that department until September, 1913, and then went to the japanning department, where he is at present. Ed is very fond of music and likes nothing better than to start his phonograph, sit back in an easy chair and enjoy himself when he gets home tired in the evening.

F. E. Hallock, twenty-five years with the Western Electric this March, can hark back to the days when C. E. Cone was head of the Shipping Department at the old New York place on Thames Street. After a few years in the Construction Department, Mr. Hallock had charge of shipping from the retail store. He is now selector in the control stock department, New York.

C. E. Forsberg struck Western Electricdom precisely twenty years before the News was born, i.e., on March 1st he had been twenty years in the Company. He began work in the machine shop; did general machine work and some experimental work; and is now in the model shop at New York.

Luigi Barbieri, who receives a badge for twenty-five years' service this month, was born in Italy and came to this country in 1892. Almost simultaneously with his arrival he began work as carpenter in the old shop located at the corner of Greenwich and Thames Streets, New York. America and Western Electric have always been linked in his mind, for Luigi Barbieri has been in the company ever since. He is in the wood finishing department.

Stock-room work has been John Volchar's line ever since he came with the Company in 1902. For some time he had charge of filling orders for factory cable when that work was under the factory cabling department. He has worked in various stock-room departments, both in the old Clinton Street shops and at Hawthorne, and is now employed in the Merchandise Stockkeeping Department.



John Volchar



P. J. Linsey



Fred Bresemann

"S" orders for spoiled parts are not very welcome in the heavy punch press department at Hawthorne. To avoid them, they employ a bench group to repair everything that is repairable. P. Linsey now has charge of this group. He started fifteen years ago at Clinton Street, drawing jack-shells on a punch press. Linsey is prominent in Hawthorne Club work and has been a Club representative for several years.

F. Bresemann has been with the Pay-roll Department since March, 1911. He is noted for his careful methods and his accurate memory, both of which are especially valuable in his line of work. Fred is a studious reader on national and international politics, and whoever starts an argument with him along those lines must be sure of his facts first. Fred will turn in his plain button this month in exchange for one with a star on it.

Every morning A. B. Nielsen catches the 6:39 train from Downer's Grove, which lands him at Hawthorne about 7:16. He doesn't *barely* catch it or *nearly* catch it; he *catches it*. During the twenty years of his service with the Company in the Woodworking Departments, Andy has scarcely ever been late. Mr. Nielsen was first employed by the late William Culley and did his part in the making of the 7,000,000 sub-sets, of which Mr. Culley sang at the 1914 foremen's banquet.

W. S. Winter, now of the Installation Department, went to work for the Company in 1902 under Jack Gould, who was then in charge of plumbing and steam-fitting. In 1905 he was transferred to Hawthorne, where he worked in the heavy machine department of the power apparatus shop for a couple of years before taking up work in the millwright department. Mr. Winter also spent a couple of years in the loading coil department, from which he went into installation work, at which he is still employed.

A. J. Schoenwald started with the Company in 1902. His early work was in stock-room, from which he was transferred to the by-products department in 1915. Later he was again transferred to the store-room department, from which he went to the piece-part tracing department, his present position. By subtracting 1902 from 1917

you will see that Tony is entitled to turn in his present service button for one with a star on it.

F. M. Warner, foreman's clerk in the Woodwork Mill Department at Hawthorne, began in the New York shops in 1902 and is, therefore, adding a star to his service button this month. He was transferred to Hawthorne in October, 1907, where he has worked continuously in Lumber Supply and Lumber Working Departments.

Anyone who can get a broken tap out of a hole is popular around a machine shop. "Charley" Oktavec shines at this unpopular pastime. Where one of his fellow machinists in the Jobbing Department 6372, at Hawthorne, breaks off a tap and cannot remove the troublesome fragment, the job is put up to "Charley." Incidentally, "Charley's" name is Adelbert, but the boys seem to prefer "Charley." He began with the Company in New York in 1902, and this month he gets a one-star button to show for it. Oktavec sounds like a foreign name, but if you ask "Charley" what nationality he is, he will tell you American. Which is certainly the proper spirit.

A couple of years ago the tennis championship at Hawthorne used to be captured with monotonous regularity by H. L. Philler, who is now a division foreman of installation at Philadelphia, which is far enough away to make Hawthorne tennis medals safe from his rapacious fingers. But Philler did other things besides playing tennis at Hawthorne. One of them was installing the Wabash exchange of the Chicago Telephone Company, one of the biggest installations jobs in the Chicago district. Another of his jobs was putting in an exchange at Camaguey, Cuba. He gets one star on his button this month.

In the days of 1902, when Jay E. White began his career as electrician with the company, all wiring was strung on porcelain insulators, and the forest of drop light cords in the office resembled a modern rope portiere. Early in 1913 it was discovered he had memorized the intricacies of the lead press equipment at Hawthorne, so the company sent him to Tokyo to show the system to the Japanese, and Jay will never exhaust the fund of yarns he accumulated on that 10,000-mile journey. As section chief in Dept. 7383, Jay is now manufacturing loading coil cores.

C. Becker, now in the installation department, started work in the New York shops. He was one of the road inspectors of installation in the days when the regular shop inspection organization had charge of that work, and from there graduated naturally into installation work. Outside of working hours one of Charley's chief amusements is pinochle, at which game he is no mean opponent.

Besides working, J. St. George's principal amusement is work. He is an installation foreman in the eastern district and has been with the company for 15 years. During the past seven years he has put in many of the biggest jobs in the New York district. St. George's specialty is completing jobs at less than the estimated expense, which in itself is ample proof that he is a hustler.

Western Electric News

Vol. VI. No. 2

April 1917

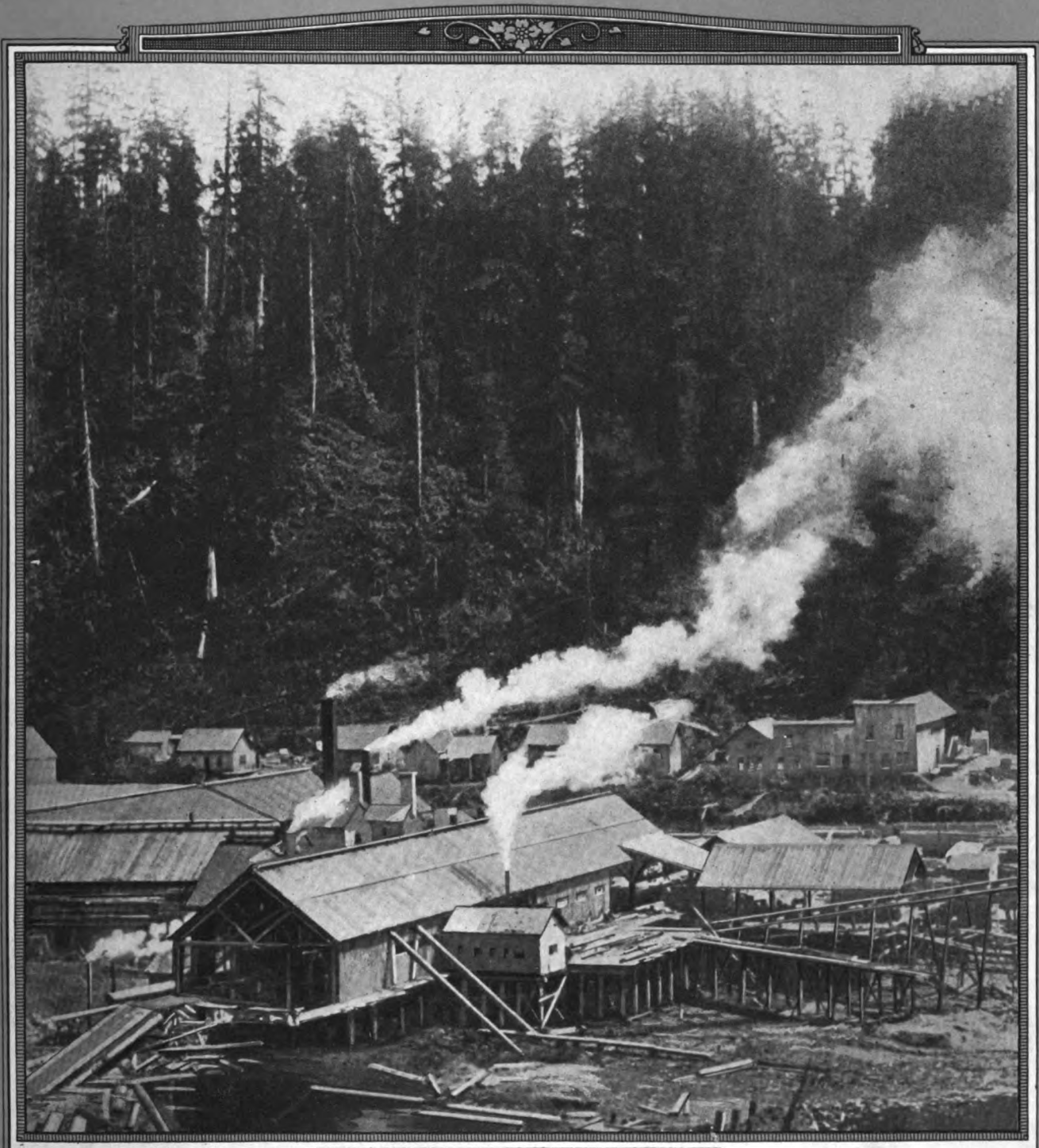

Crossarms in the
Making

Fellner

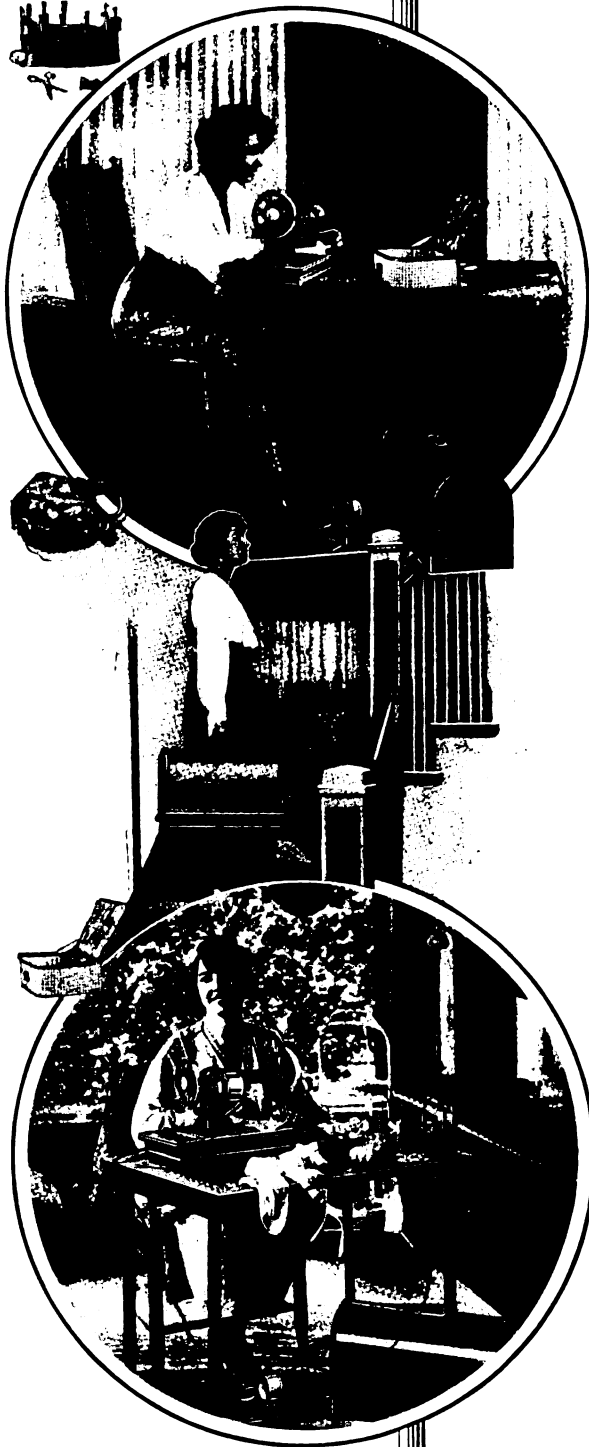

Every woman's dream has been for a machine that she could carry to any room in the house.

Downstairs, Upstairs Sew Anywhere

with a

Western Electric Portable Sewing Machine

SMALL—It's no bigger than a typewriter.

PORTABLE—Wherever there is an electric light socket—in the living room or bedroom in winter, out on the porch in summer—you can now do your sewing at will.

ELECTRIC—No more of the backache and tiresome treadle pushing of the old fashioned machine. A touch of the foot starts the electric motor and this tireless little electric servant sews on for an hour or for a day.

GUARANTEED—A ten-year guarantee goes with this sewing machine. It is a Western Electric Quality Product.

INEXPENSIVE — Only \$35.00 (\$37 west of the Rockies) for this complete outfit. Think of it—less than you have had to pay for most any of the well-known machines of the foot-power type.

If your lighting company or electrical dealer cannot show you this wonderful machine, write to nearest office for Booklet No. 508-J.

WESTERN ELECTRIC COMPANY

INCORPORATED

- | | | | | |
|--------------|-------------|--------------|---------------|----------------|
| New York | Atlanta | Chicago | Kansas City | San Francisco |
| Buffalo | Richmond | Milwaukee | Omaha | Oakland |
| Newark | Savannah | Indianapolis | Oklahoma City | Los Angeles |
| Philadelphia | New Orleans | Detroit | Minneapolis | Seattle |
| Boston | Houston | Cleveland | St. Paul | Portland |
| Pittsburgh | St. Louis | Cincinnati | Dallas | Denver |
| | | | | Salt Lake City |

EQUIPMENT FOR EVERY ELECTRICAL NEED

Another advertisement—a part of the Spring drive on the Portable Sewing Machine.

Western Electric Company

INCORPORATED

MILITARY AND NAVAL SERVICE

To Employees:

The telephone service of the Bell System is of the utmost importance to the military authorities and to the effective mobilization of the country's industries in preparation for war, and their conduct during war, if war occurs. To avoid crippling or impairing that system of communication and to meet the demands for increased service, and to provide the Army and Navy with such material as this Company is qualified to supply, it is necessary that we should maintain an adequate and experienced personnel. True loyalty and patriotism will require of some of our people that they continue at their present work, rather than seek more direct military or naval service in the Government organizations.

The Company has undertaken certain engagements with reference to members of the National Guard and Naval Militia called into service under the President's proclamation of June 18, 1916, and with reference to such employees as become members of the Signal Officers' Reserve Corps or Signal Corps Section of the Enlisted Reserve Corps.

Employees of the Company who were members of the National Guard or Naval Militia on the 18th of June, 1916, or who have since become members with the consent of the Company, if now on active service or if called into active service by the Federal or State authorities, shall while on such service, up to and including June 30, 1917, receive from the Company their full regular pay, less the pay they receive from the Government for military service.

After completion of military or naval service, such employees will be given such employment as the needs of the Company permit and as the employee is qualified to undertake.

Under the Employees' Benefit Plan such employees returning to work for the Company after the completion of military service, shall be considered as having been continuously employed, but no benefits shall accrue to them during their absences.

As to future enlistments in military and naval organizations which may require absences from the Company's employment, it is required that in order to receive benefits from the Company the following procedure shall be observed:

1. An application for the Company's approval of enlistment shall be made.
2. If it be found that such enlistment does not interfere with the Company's ability to perform its duties to the country, permission to enlist shall be granted.

To only such as shall receive permission as above described and were in the employment of the Company April 1, 1917, or during a period of one year before enlistment, will benefits be extended by the Company. The benefits so extended will depend upon the merits of the case and will probably take the form of payments to dependents during military and naval service of employees and of reemployment after the completion of such service.

April 2, 1917

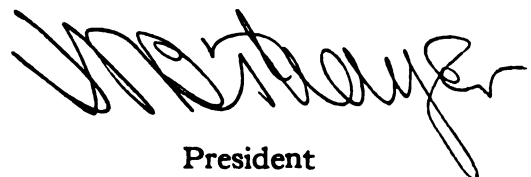

President

very informally, as you might say, and rip it into lumber, more or less accurately. In fir the timber is sometimes so large that the logs must be shattered with gunpowder before they are small enough to go into the saw-mill carriage. In the South, a few pine logs may be hauled to a mill in a town, while in the West there usually is a saw-mill camp and a large organization. In North

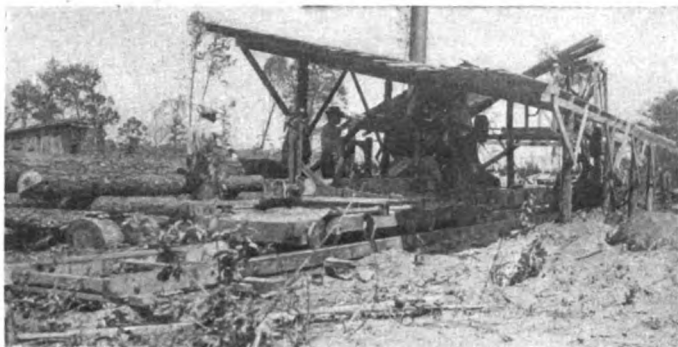

A Portable Yellow Pine Saw Mill

Carolina we are accustomed to have the timber supply halt while a farmer goes to camp meeting or to the circus, hoes his cotton or hunts squirrels, attends a revival or gets mixed up with the sheriff on booze. In the West there is the woods with its railroad and its own bunk houses and cook houses, the saw-mill and planing mill, power plant, club house, church and commissary, and its groups of people; up the "Creek" are the Virginians, with an occasional feudist—but he leaves his feud East. The operators are often old Wisconsin, Michigan or Minnesota lumbermen; the qualifications of the head of the business must be those of a Captain of Industry, an agent for "First Aid to the Injured" and a first-class funeral director.

Just as the two woods are different and the sections of the country from which they come, so do the obstacles in getting crossarms differ. The Western people have reasons for failure of schedules, different from those advanced in the South—but equally effective. Fourth of July celebrations, snows, floods, forest fires. Last winter one storm was a heavy snow in the mountains that put the big mill out of business in the woods, and a great rain in the valley, which put out the fires at the next larger mill. In the South the men will not work when it rains and in the West they rather like rain but the snow ties them up.

The Matter of Preservation

The West Coast crossarm (Douglas Fir) is used in its natural state, as it is stout and long-lived. Southern yellow pine has strength but without a preservative the sapwood rots quickly—"goes to pieces" as we say more kindly. The Western Electric were pioneers in this country in the use of creosoted crossarms and poles. "Rot" is, in fact, a very **simple animal** which eats its way through the fibre of wood and leaves a product equivalent to worm casts on a golfing green—than which there is no more useless thing on earth. There are many preservatives, all aimed at the life of the aforesaid "simple animal" and of these creosote oil is the best. There is creosote and "near creosote"; the first prevents rot and the second has a dark complexion. But the kind of arm that gives little more

than a look and a tarry smell, never gets further than our Inspection Department.

The Strength of Crossarms

As to strength the crossarms vary considerably, depending on the species of wood used and upon variables in wood of the same species, such as irregularity in the density of fibre and the presence of knots or crossgrain. We have found by test that the average crossarm which is ten feet long, will carry 4,000 pounds distributed equally at the pin holes. It is seldom that we find an arm complying with all the requirements of our specifications, which will break on a load of less than 3,000 pounds.

The strength of arms is not a specification requirement, for the reason that there is no practicable way to measure this strength. The load which it is desired that the arm be capable of carrying is one which on test would permanently bend or partially break a very large proportion of arms, and thus render them unfit for sale. Nevertheless, most of the arms, would, if placed in service without a test, support the required load. Slight distortions which develop after installation in a line are not considered serious, although the same degree of distortions in an arm in our stock would make it impossible for the Western Electric Company to sell the arm.



Bringing Yellow Pine Logs to the Saw Mill

Therefore, the method we use for selecting usable arms, and discarding the unusable arms is one of visual examination. Specification restrictions have been established on the slant of grain, size of knots, checks, pitch pockets, wane, and manufacturing irregularities, based on the loss of strength when these irregularities are present either separately or collectively. The theory on which the restrictions are computed, is that a crossarm entirely free

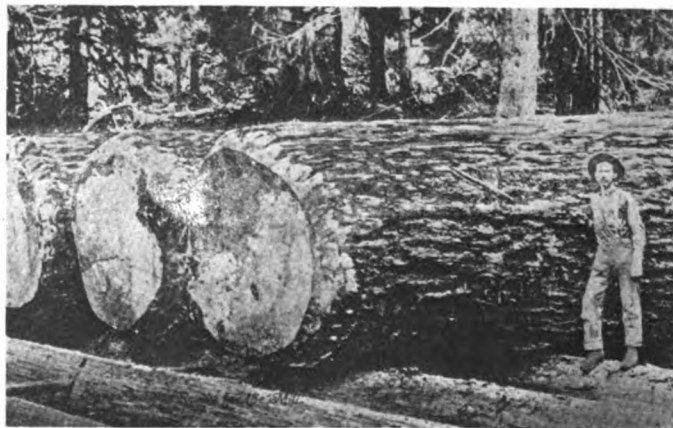

Douglas Fir Crossarms Come from Logs Like These

from defects possesses a factor of safety in strength. This factor, whatever it is, is determined for each part of the arm, and allowances are made for timber irregularities which will admit the mill run of lumber, in so far as this be done without detracting from the usefulness of the arm.

These restrictions are embodied in a specification, which forms the basis for the purchase of the arms from the manufacturer and of the inspection of the arms. All arms supplied to the Western Union Company and to the Bell companies are inspected.

During the year 1916 the Associated and the Western Union companies purchased arms as follows:

	Assoc. Co's	W. U. Co.	Total
Fir	276,179	296,000	572,179
Yellow Pine	439,670	439,670
Cypress	60,415	60,415
	715,849	356,415	1,072,264

Ten years ago, most people ordered, say—"1,000 cross-arms," giving dimensions and borings, and took whatever came that answered that very uncertain requirement. The manufacturers were generous enough to paint them without an additional charge and in the early days some of them grew rich by a generous use of putty and red paint. A classic incident is that of the Georgia manu-



Sometimes a Snow Like This Comes Along in the West Coast Woods and then, Goodnight Work in the Woods!

facturer who painted a certain lot of arms with a combination of water and red Georgia soil, but was careless enough to leave them out over night.

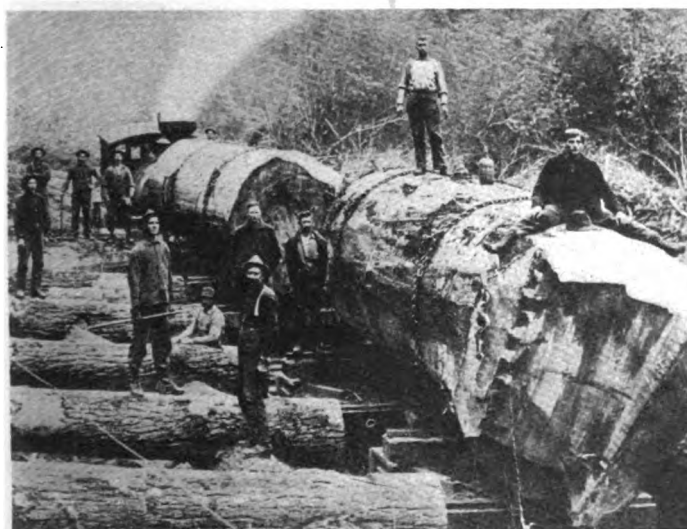

Bringing Douglas Fir Logs to the Saw Mill

Nowadays the buyers know better; we no longer handle the "commercial" crossarm in which the paint and the putty cover a multitude of sins of manufacture but furnish a "heart-content" yellow pine arm, a fir arm that has stood the test of time or a creosoted arm that aims to defy eternity.

The choice as to the kind of an arm to use is, of course, made by the operating company which purchases the arm. The Western Electric Company's function is to fill the customer's order with the kind of material called for. However, it has been our observation, that each customer chooses the arms which according to his computations will be the most economical for the annual plant cost basis. The factors which he considers are the price (delivered) and the probable life in service. The price data, of course, is supplied to the operating company by the Western Electric Company. The life of an arm is a variable factor, depending upon climatic conditions, as well as upon the kind of an arm used.

Ice and Snow Are the Crossarm's Foes

The crossarm which to-day is in general—almost universal—use among telephone and telegraph companies, is ten feet long, and is designed to support ten wires.

In heavy toll line construction work, copper wire as large as No. 8 B. W. G. is used and the poles are spaced 130 feet apart. A 130-foot length of No. 8 copper weighs 10.7 pounds. When coated with ice, one inch in diameter, the weight reaches fifty pounds. In extreme cases the ice reaches a diameter of two inches. The weight then becomes approximately 160 pounds. In service the dead weight on each crossarm of ten wires, coated with ice, may therefore be as great as 1,600 pounds. This strain, tending to break the arms, may be increased somewhat by wind pressure. A seventy-mile side wind, on the ten wires, coated with ice two inches diameter might exert a pressure as great as 1,700 pounds. Generally speaking, this pressure would be in a horizontal direction and would not be a direct breaking strain on the arm. However, winds do fluctuate from the horizontal, also they cause swaying of the wires, thus throwing additional vertical strain on the crossarms. The maximum load on the arm is generally estimated as the resultant of the maximum wind and maximum weight.

Results of New Customers and New Business Contest for January, 1917

The salesman securing the largest number of new customers during January was:

D. F. Roseborough, Omaha.

The salesmen securing the highest number of points for sales to new customers during the month of January were:

J. E. Lowrey, Dallas, 88 points.

A. B. Spicer, St. Louis, 72 points.

A. B. Vandercook, Los Angeles, 70 points.

Western Electric Report to Stockholders

FOR THE YEAR OF 1916

Western Electric Company

INCORPORATED

195 Broadway, New York City

DIRECTORS

H. A. HALLIGAN
W. H. MINER
A. L. SALT

W. P. SIDLEY
GERARD SWOPE
H. B. THAYER

March 19, 1917.

To the Stockholders:

Since the last annual meeting of Stockholders, the Company has lost the wise counsels of Mr. E. M. Barton, a Director and Chairman of the Board.

Mr. Barton was one of the founders of the business and gave it his service over a period of forty-four years, during the most of that time as the executive head of the companies of which this is the successor. He died May 3, 1916.

The profits of the Company are derived from the sale of telephone apparatus and cable of our own manufacture, and the sale of merchandise not made by us, and from our investments in foreign manufacturing companies in similar lines of work.

While the output of telephone apparatus has been large in 1916, the deliveries were principally during the latter part of the year and on orders received considerably earlier in the year, as in this class of work some months elapse between the beginning of the process of manufacture and the final delivery of the finished apparatus. The costs of all the items going into the cost of manufacture have rapidly increased during the year, so that the profit on this department of the business has not been proportional to the volume.

On sales of cable and merchandise not of our own manufacture, where the turnover is quick, the profits have been satisfactory.

As to the foreign manufacturing companies in which we are interested, our information as to the most of them is meager, but we understand that they have, with the exception of the one at Antwerp, Belgium, been employed on fairly profitable work during the year. Whether a satisfactory profit will remain after the payment of war taxes in the several belligerent coun-

tries is not so certain. No dividends have been received by us, so that our foreign investments have made no contribution to our profits of the year, as shown in the statement.

Manufacturing conditions in this country during the year have been extremely difficult. It has been almost impossible to provide a regular supply of material, not only on account of the general shortage, but also on account of the uncertainties of freight transportation. The demand for our products increased very rapidly during the year and the necessity of meeting this demand has taxed all available resources for machinery, tools and other expense items.

Our shop force increased during the year from 10,838 to 18,928 employees. The total number of employees at December 31, 1916, was 26,878.

In recognition of the loyalty and efficiency with which the employees have met and are meeting the difficult conditions of the present time, your directors authorized the distribution of certain extra payments to them, as shown in the Statement of Earnings.

The sales for 1916 were \$106,987,000. For 1915 they were \$63,852,000, and for 1914 they were \$66,408,000.

The orders on hand at December 31, 1916, were \$22,028,000 in value more than on December 31, 1915. The average value of an order filled during 1916 was \$75 as compared with \$55 for 1915.

The total disbursements from the Employees' Benefit Fund for 1916 amounted to \$185,344. These payments covered all classes of benefits and were made to 2,789 beneficiaries.

Statements of Earnings and of Assets and Liabilities of this Company and its constituent Companies in the United States are appended.

For the Directors,

H. B. THAYER.

Mr. Albright a Vice-President



Henry F. Albright, Vice-President and General Superintendent of the Western Electric Company

AT a meeting of the Board of Directors held on March 6th, Mr. Henry F. Albright, General Superintendent, was elected a Vice-President of the Company. He will continue as General Superintendent in charge of the Manufacturing Department.

• • • • •

Henry Fleetwood Albright was born on October 5, 1868, in Lancaster, Pennsylvania. He was educated in Philadelphia and entered the employ of the Western Electric Company in 1892 as a salesman at Chicago. Two years later he was transferred to the Construction Department

at New York, and in 1897 became Factory Engineer at New York. This position he occupied for one year and then became Assistant Superintendent. In 1899 Mr. Albright was made Superintendent at New York. In 1908 he became General Superintendent at Hawthorne.

Mr. Albright was married in Philadelphia on December 24, 1892. He has two children. He is a member of the Union League Club of Chicago and of the Oak Park Country Club. Mr. Albright is also a member of the Institute of Electrical Engineers, London, and of the American Society of Mechanical Engineers, as well as a Fellow of the American Institute of Electrical Engineers.



F. B. Jewett Now Major in Signal Officers' Reserve Corps

FRANK B. JEWETT, Chief Engineer of the Company, is among those recently commissioned in the Signal Officers' Reserve Corps, U. S. A. His appointment and the details of the reserve organization are commented on as follows by the *Army and Navy Journal* in a recent issue:

"The plan of those having the work in hand was to co-ordinate the Signal Officers' Reserve Corps with the organizations of the Western Union Telegraph Company, the Postal Telegraph Company and the American Telephone and Telegraph Company that, when a crisis came, the essential parts of these concerns—personnel as well as equipment—might be turned over to the government. That this has been accomplished can be stated without violating a military secret, and also without danger of exaggerating the facts.

"Through a system of 'districting' the country, a reserve organization has been formed in each district, with a reserve officer of high rank in command who has under him, in the S.O.R.C., the same men and equipment over which he has jurisdiction by virtue of his commercial position. When the call comes the only necessary steps to be taken will be for the district telephone or telegraph manager to don his uniform. His staff and the men who

are to form the enlisted portion of his command will be already in their places and will have become thoroughly acquainted with the parts they are to play. The following officials (already dubbed 'The Big Five S.O.R.C.')

have either been commissioned or have been recommended for commissions and have signified their intention of accepting:

"J. J. Carty, chief engineer, A. T. and T. Company, 195 Broadway, New York city; George M. Yorke, vice-president, in charge of plant and engineering, Western Union Telegraph Company, 195 Broadway, New York city; F. B. Jewett, chief engineer, Western Electric Company, 463 West street, New York city; Charles P. Bruch, vice-president and assistant general manager, Postal Telegraph and Cable Company, 253 Broadway, New York city; F. A. Stevenson, general superintendent of plant, A. T. and T. Company, 195 Broadway, New York city.

"The five men named above are representatives in the S.O.R.C. of the companies from which they were chosen. The selection of Mr. Jewett is regarded as particularly fortunate. He is at the head of the research department of the Western Electric Company, which manufactures the greater part of the communications equipment used in the Signal Corps."

Hiring for Hawthorne

A Few Details Involved in the Job of Giving Out Jobs

MOST men feel that their hands are full and their cup of woe overflowing when the wife is sick and they have to hire a halfway competent girl to do the housework. Multiply their little problem by about 32,000, and you get what the Hawthorne employment department was up against in 1916. During the year just past this department hired 31,834 people. The number of employees at Hawthorne increased by between nine and ten thousand during the same period, making the force about 20,000 at the end of the year.

It may seem astonishing to the uninformed that to increase the force to approximately 20,000 and maintain it there, nearly 32,000 people had to be hired. Of course, a great many changes are to be expected every year in a force of 20,000. Girls leave to get married; young people living at home quit because their parents move to some distant part of the city; other employees are lost through sickness, death, etc.; some have to be discharged. But, allowing for all these, there remains a large number who leave for causes that are not *reasons*. Employment spe-

cialists classify them as "floaters" in recognition of their propensity for drifting about from one job to another, as the whim strikes them. Young people without family responsibilities and unskilled workers form most of this class, which, of course, is most in evidence when work is plentiful. Its principal characteristic is that trait of (more or less) human nature that leads a horse to overlook the tender grass on his own side of the pasture fence to reach his head through the rails and nibble on the other side. Which shows that even a horse does not always use "horse sense."



Men Applicants in the Hawthorne Employment Office

cialists classify them as "floaters" in recognition of their propensity for drifting about from one job to another, as the whim strikes them. Young people without family responsibilities and unskilled workers form most of this class, which, of course, is most in evidence when work is plentiful. Its principal characteristic is that trait of (more or less) human nature that leads a horse to overlook the tender grass on his own side of the pasture fence to reach his head through the rails and nibble on the other side. Which shows that even a horse does not always use "horse sense."

Still we can all partially understand the mental processes of the person who tries a job for a few days and then quits to try another. Most of us have our days when we feel tired of our jobs, disgusted with ourselves and at outs with the world in general. Of course, when those spells come on, we simply sic our common sense onto the "blue devils," and leave them to fight it out while we go home and get a good night's sleep. Our common human frailty, however, gives us some sympathy for the person without

a keel of good sound judgment to keep him from tipping over at every breeze. But who can understand the peculiar mental twists that lead a person to apply for a job and then never show up to take it, as was the case with one out of every eleven applicants at the Works during the past year? In fact, the proportion was somewhat greater than one in eleven. In actual figures 2,951 out of the total 31,834 persons hired did not report for work at all, after taking the trouble to make a trip to the Works and go through all the employment routine. There is personal efficiency for you! Such people are as welcome in an employment department as the measles in a public school. But they are not so easy to detect.

Come Follow Yourself While You Apply for a Job

If you have no objections we'll have you be a hand-screw-machine operator. We'll meet you at the main gate when you come for a job. Now the first thing to do is tell the police officer what you want. He will direct you to the section of the employment department where men shop employees are hired. There are three other sections—one for women shop employees, one for women office employees and one for men office employees. This arrangement allows certain interviewers to specialize in certain classes of help.

Now in the first place, how do the employment people know that the Shops want any hand-screw-machine operators, or any other kind of operators? How do they know how many and what kind of employees to hire at any time? Form 256 GN tells them. In case you fail to find out what form 256 GN is, ask the stationery department and they will tell you it is a requisition to be filled in by any department chief who needs workers. It notifies the employment department to "Provide help as follows," describing, under printed headings, the kind of help wanted, the number, the rate of pay, why the new help is needed, whether they will be required temporarily or permanently and the section and floor where applicants are to be sent.

Knowing, then, from form 256 GN that Joe Wildbore wants three hand-screw-machine operators, and judging from your handsome, intelligent countenance and straightforward answers to a few preliminary questions that you will make a likely candidate for one of the jobs, the interviewer asks you to fill out an application form. This is a very inquisitive form and wants to know many things. You can see at a glance why it asks some of these—your name, address, telephone number, age, schooling, work wanted, wages expected, etc. It also wants to know your birthplace, birthday and certain other information, which

is later used by the cashier's department to identify employees before cashing their pay checks. Since employment with some telephone company or previous employment with the Western Electric Company constitute training in our general field of work, it asks you to give any such experience you may have had. If you are an ex-employee of the Western, of course, the department's records show whether or not it is advisable to re-hire you. This line, "Have you any relatives in the employ of this Company If so give names," is put in because of a Company rule which prohibits near relatives from working for each other. That rule, of course, is to prevent possible favoritism. Here is an important section of the application—this part headed "Former Employers." It asks for the name and address of each of your last four employers, the kind of work you did for each, the length of employment, date of leaving, reason for leaving and wages received. One of the main reasons for this section is to defeat "floaters." When an applicant's record shows three weeks with Jones & Company, one month with Brown Brothers, and five days with Smith's Sons, with such reasons for leaving as "Didn't like job," "Work too hard," etc., the employment people know what to do and they don't hesitate to do it. So if you are one of that kind you may as well start home right now. Otherwise we'll go ahead and finish the application. Now just list a few references here at the end and we're through.

Ever Hear the Story About Horace Greeley?

However, we strongly advise against your presenting one of the sort tendered by a recent applicant, who had evidently heard the story told of the printer discharged for incompetency by Horace Greeley, who will long be remembered for his famous editorial writing and his infamous handwriting. The printer, as you will remember, took the note informing him of his discharge and went out to look up another job. The first man to whom he applied asked him if he had any references. "Only this one from Mr. Greeley," he answered, presenting the dismissal notice—and the "reference" got him the job. Profiting by this "intelligent compositor's" example, our applicant presented a reference which read: "To Whom It May Concern: This is to certify that A. R. N—— worked for us five months and that we found him is satisfactory." The incorrect grammar in an otherwise well-typed letter aroused suspicion and a closer investigation disclosed that the applicant had substituted "is" for "un" in the original, which had stated—"we have found him unsatisfactory." With the "un" rubbed out there was a tell-tale space, which "is" filled up very nicely, as far as appearances went. Perhaps it is needless to add that the employment department at once decided that the "un" of his former employer's estimate of him held for the Western Electric Company too.

Many experiences similar to this have made our employment people exceeding wise, and they will write to all your former employers and to the people you have given as references, to make sure that all of your statements are correct. There is nothing personal to you about the matter, either. It is done with every application as a matter of department routine.

Now take your application over to the interviewer. He will ask you a few questions to determine whether you will make a desirable employee, assuming you to be a com-

petent hand-screw-machine operator. That point he leaves to the foreman to determine, as it takes a man fully acquainted with the details of your trade to know whether you are competent to produce work up to Western Electric standards. Except in the case of certain classes of skilled help, however, the employment department interviewers hire the applicants without first referring them to the foremen.

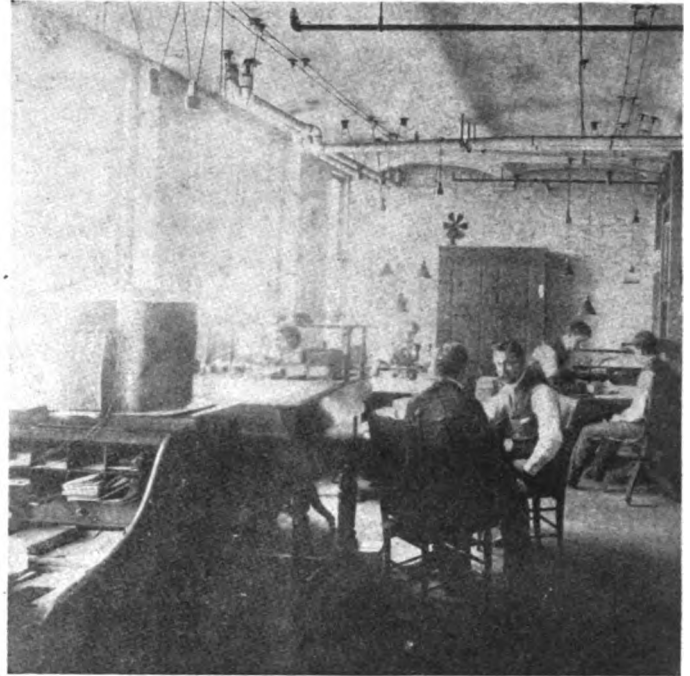

First Employment Office, Clinton Street. The Desk in Foreground is the Office—the Rest of Space Belonged to the Payroll Dept. J. W. Johnston, Now Company Treasurer, Whose Back Shows Well in Illustration, Was Employment Office Force. Facing Him is J. G. Sharp, Now Head of Financial Department, Hawthorne

An ideal employment interviewer should be a combination diplomat, psychologist and detective—a diplomat for tact in dealing with people, a psychologist to determine whether their mental traits are such as to make them able, dependable employees, and a detective for cases like this:

The name on the application blank is "Mary Flynn" and the presumption is that the interviewer can read, yet after a searching look at the swarthy-faced girl confronting her she asks: "What is your name?" "It's right there on the paper—Mary Flynn," answered the girl with a just discernible Polish accent that confirms the interviewer's suspicions. "Yes, I know, Mary," she replies, "but what is your real name? What did you call yourself when you worked here before?" Mary is indignant. "What do you mean, worked here before?" She never even saw the place before. Yet a little more judicious questioning finally reveals the fact that her name is Mary Brazinski and she once worked for Wiley in the coil-winding department, but left without notice. Mary, it seems, believes in letting by-gones be by-gones and starting out afresh. She had figured her chances of getting back to be better if she censored all news regarding her previous unceremonious leaving. Well, we all make bad guesses sometimes, and Mary returns home jobless and perhaps at least partially convinced that honesty is the best policy after all.

This form of deception is one often tried, especially by women, who find it easy to alter their appearance by a new style of hair-dressing, a differently shaped hat and other little tricks of the sex. Sometimes one who is away from her department on sick leave is discovered working in another department under a fictitious name, the big idea being to try out the second job and, in case she doesn't like it, to resign and return to the first position. The unfortunate feature of this clever little scheme is that she suddenly finds herself without any position to return to.

You See the Foreman

But pardon us for putting Mary Brazinski in ahead of you. Let's see—you were waiting to go over and talk to the foreman of the hand-screw-machine department, weren't you? This envelope, which the interviewer gave you, will get you there. After it has been approved here on the right-hand corner it serves as the police officer's authorization to "Pass the bearer to Mr. J. E. Wildbore, Dept. No. 6336." Inside is your application sheet and a slip stating that "The bearer, Mr. Y. O. Ewe, is sent in response to your requisition for hand-screw-machine operators. Please fill out blank, as indicated, and return it to employment department with applicant." If you are accepted the department chief will fill in the lower half of that slip, stating: "Applicant accepts at so much per hour to report at such and such a date. This addition is due to vacancy (or permanent increase or temporary increase) in Dept. No. 6336." If the foreman does not hire you he fills in the reason after the line "Applicant rejected on account of—." In either case the employment department has a full record of the action taken.

After proving to Joe's satisfaction that you can make a hand-screw-machine sit up on its hind legs and jump through a hoop, you return to the employment department. Your next step is to take an "Applicant's Pass to Medical Dept.," and go over for a physical examination. You first sign the pass, so that the medical department can compare this signature with your signature on the Physical Examination form, which you will be asked to sign, to make sure you have not smuggled over a healthy substitute to be examined in your stead. Such tricks have been tried.

The Medical "Exam."

And yet, even though it should keep a man from getting a job, such a physical examination is often worth that and much more to him. Sometimes it lays bare some unsuspected trouble, still curable but in such a stage that even a few more months' ignorance of it would mean an early death. Very often it brings to light minor troubles that have been making a man "feel miserable," keeping his energy and efficiency below par and preventing him from doing justice to himself in competition with other workers. The examination also prevents persons with certain physical defects from getting into positions where these defects might be dangerous to themselves or to others. A man with impaired vision, for example, would never be allowed to drive one of our trucks. Neither could any one suffering from a contagious or infectious disease get a position under any circumstances. Every precaution must be taken so that Hawthorne employees shall not be subjected to any such risks of injury or infection.

This means, of course, that the physical examination must be complete and thorough. It is about the same as

that given by the better life insurance companies. The results are entered on a Physical Examination form. The first part of this is filled in with your answers to such questions as "What diseases have you had? What injuries, accidents or surgical operations, have you had?" etc. The rest of it—height, weight, temperature; condition of tongue, teeth, gums, throat, nasal passages, vision, lungs, heart, hearing, etc., etc.—are filled in by the medical department, from the results of the examination. This form is kept permanently in their files. The examining physician informs the employment department of his findings by writing "Accepted" or "Rejected" after the word "Report—" on your "Applicant's Pass to Medical Department," and signs his name on the line above the words "Examining Physician." You may be interested in knowing that six physicians are constantly employed at this work.

You Get Your Pass

After you have passed the doctors successfully the next procedure is to take the medical pass back to the employment department, which then gives you a "New Employee's Pass." Without this, of course, you could not get into the Works. This pass gives your name, department number, its location, the foreman's name and the time you are to report for work. When you come in to work the police officer will write here under "Reported," "7:15 A. M.," or whatever time you hand him the pass. He will also fill in the date and sign his name, after which he will make sure that you know the way to your new department. It is easy to get lost in Hawthorne's enormous buildings.

When you reach your department the foreman's clerk will take up your pass and give you one of the regular metal-rimmed working cards, bearing your name, clock number and department number, and signed by your foreman. This is your permanent means of identification to the Works police officers. You must sign this working card on the other side and also sign an Employee's Identification Card before you become a full-fledged employee. The clerk then assigns you a locker, shows you your number on the clock, and turns you over to the foreman or his assistant, who puts you to work.

That ends the process of being hired as far as you are concerned, but some of your newly acquired fellow employees still have a few necessary things to attend to before you can draw any pay—and that may be a matter of some slight importance to you. The foreman's clerk in your new department, after signing his name as a witness to your signature on the Identification Card, must send it, together with your New Employee's Pass, to the employment department, which thus knows that you have reported for work. Your department clerk also sends over a "Notification of New Employee" form as soon as he can prepare it. In addition to your name, department number and other identifying information, it gives your rate of pay and the standard labor classification you come under ("hand-screw-machine operator," in your case). This form and your application sheet furnish the information for a rate card, which the employment department makes out and sends to the pay-roll department as a notification to enter you on the pay-roll. It gives your name, clock number, department and other identifying information, as well as your rate of pay, and is kept in the pay-roll department's files.

The employment people must also complete the Identification Card you signed when you reported for work. They first check your signature, your birth-place, birth-date and other data with what you have given in your application, to make sure that somebody else did not apply for you. This precaution has resulted from long years of contact with "ways that are dark and tricks that are vain," in which the heathen Chinese has nothing on occasional applicants of less maligned nationalities. The Identification Card finds its final resting place in the files of the cashier's department, where it is used in checking signatures on pay receipts and to make sure that the person presenting a receipt is the one to whom it was issued.

Well, You Are Finally Hired

Even yet the employment department is not rid of you—in fact, it never will be again. As long as you work for the Company it must file, every six months, the records of your attendance and earnings as compiled by your department clerk on forms provided for that purpose. If you leave the Company it must file the Ex-Employee's Record Card giving all the details. All such information is placed with your application sheet, medical department pass, foreman's interview slip, etc., in an individual folder, which is held indefinitely in the department's files.

However, the department is now almost through *hiring* you. All that remains is to send out inquiries to your former employers and to the persons you gave as references. When the answers are received they will be very carefully considered. If they are found satisfactory they are filed in your folder and the department considers you definitely hired.

However, it is not always an easy task to draw correct conclusions from these replies. Although many of them are impartial and judicious in tone, giving a very fair estimate of the applicant's characteristics and qualifications, there are also many that are practically valueless. Some of these show plain evidence of a personal spite. In such cases it is very difficult to draw conclusions that are fair to the applicant. Other employers adopt the "I'm neutral" attitude, making their replies purposely vague

or ambiguous, like the one who, according to the story, wrote: "The bearer, Worth Nix, left of his own accord after working for me two weeks. I was perfectly satisfied."

Incidentally, if the employer meant what he seemed to state—that he was perfectly satisfied to have Nix leave after two weeks' employment—Worth must have been a very poor workman indeed. These two-weeks' sojourners cost employers an enormous amount of money every year. The first week or so, when a new man is getting acquainted with his job, he is of very little use to a company. Therefore, if he is the kind who quits about as soon as he begins to get familiar with his work, he costs his company not only the expenses of hiring him, but practically all his wages as well, since most of his time has been spent in learning to do his work and almost none in doing it. He also costs the price of all material he spoils, any damage his ignorance may cause to tools or machines, and the time of the foreman or group head who "breaks him in," not considering losses due to the slowing down of production. Experts compute the cost of training a new employee as between \$10 and \$200, depending on the kind of work he is to do.

What the Records Show

Yet, in spite of the efforts of the employment department to steer clear of this sort of "help" the records show that the majority of all employees leaving have been with the Company less than six months. The natural inference is that they are of the dissatisfied class who do not stay in any place long enough to form a real estimate of its desirability from the standpoint of chances of advancement, good working conditions, liberal management policy, etc. This conclusion appears to be borne out by our records, which show that 91 per cent. of all employees who had been with the company during the whole of 1915 stayed with us through 1916 also.

The answer to the employment question, then, seems to be: Hire only people who will stay long enough to get acquainted with the family. And the question to that answer is: How are you going to find out in advance just how long anybody will stay?

Which leaves you with something to think about.

Lines Written to the Board of Editors Upon the Occasion of Their Having Dropped "Around the Wax Pot" Out of the March Issue.

By E. C. Gatrall, Fairmont, W. Va.

THE WESTERN NEWS is five years old
As every one now hears;
And for itself has gained repute,
In the passing of the years.
In looking through the issues old,
I've tried in vain to find
A chance to kick, a stone to throw.
But could not—cruel, or kind.

But on its fair escutcheon now
There is an awful blot:
You've cut the heart out our "Mag,"
You've doused the old "Wax Pot."
Now, Mist'ers Editors, I'm sure
I voice the entire field—
Just put the "Wax Pot" in again,
And to my pleading yield.

Lines Written to E. C. Gatrall, of Fairmont, W. Va., Upon the Occasion of His Having Written Lines Upon the Occasion of, etc., etc.

By the Board of Editors

THE WESTERN NEWS is five years old
As you correctly state,
But we confess that we have not
Up to this present date
Unearthed a way to print the page
"Around the Wax Pot" styled,
Unless installers monthly take
An interest in their child.

The Board, it works no miracles,
It does not understand
The art of making strawless bricks
Or weaving ropes of sand;
You say we've "doused the old Wax Pot"—
Let us now juggle similes
And say the "Wax Pot" quite depends
On how much wax comes from the bees!

Calories and the H. C. L.

Every Little Foodstuff Has a Fuel Value All Its Own

“A DISH of prunes am a very nice thing to finish up breakfast with, boss,” volunteered Sam, the tyrant of the dining car.

I pursued prunes over the menu, and trailed out its price. They were fifteen cents, so I consented. When they arrived I counted them up. If there had been three less you could not have used the plural. With uncanny instinct Sam saw a protest smouldering in my mind, and sputtered out:

“You see, boss, even prunes is going up. Dis war in Europe certainly is making prices *airioplane*.”

There it went, for the fiftieth time since I had left home! Everybody, from the waiters to the big business men, was talking it. It was getting to be awful. I began to see what Robbie Burns must have been thinking of when he wrote: “*Man’s inhumanity to man makes countless thousands mourn.*”

Four prunes fifteen cents! I strode to the smoking car.

“Morning!” cried a well-dressed, happy-faced fellow of thirty, from behind a newspaper. I greeted him and sank gloomily into a seat. The prunes rankled—mentally.

“You’ve got a newspaper, I see. Has Congress decided to arm the potato trains or fortify the nation’s onion patches yet,” I said.

He laid down his sheet, and laughed.

“So you’re squirming under the H. C. L., too, are you? Well, it is hard.”

This was my cue for narrating the tragedy of the prunes, and he listened sympathetically.

“It is getting to be awful, there is no doubt about it,” he said. “We’re getting awful prices crowded on to us, and yet I dare say that the only resistance that most of us offer is grumbling. At any rate, I know that that used to be the way with me until I woke up, but now”—and he looked very proud about it—“now, to all practicable purposes my wife and I have knocked the L out of H. C. L., and you know it isn’t such a hard thing after all.”

I surveyed him with a skeptical eye.

“How have you done it?” I asked in fine scorn. “Given up eating?”

“Exactly,” he said. “I have given up eating—unnecessary

things. And I’ve taken to eating other things that are a better buy for the money. Briefly speaking, the results have been fine. I have put on weight, and, what’s more, at the same time I have anchored my food bills somewhere near to Mother Earth. But don’t get me started. I’m a bug on calories and all that, and I would talk you tired if you would let me.”

“Don’t move,” I said, sidling up to him. “If you say you have invented a way to beat the high cost of living I want to buy you for an hour. Pray consider yourself engaged.”

And he talked.

“My wife started it. The first year we were married we ate on a sort of conventional schedule that was pretty much routine—meat and potatoes and white bread made up the bulk of our meals, just as it does, I suppose, for most other families. We paid what the butcher, and the baker, and grocer and candlestick maker asked, until finally my wife came around, and as Lady of the Exchequer intimated that the appropriation of the Government (that’s me) for the Department of the Interior gave signs of being exhausted long before schedule.”

“We’ve got to do something, Jim,” she said, “and I am strong for changing our whole system. Just for fun, let’s buy for nutritive value for a while,” and she brought out these tables.”

My smoking car friend took them out of his pocket-book as if they were cherished papers of great value.

“To get these statistics,” he said, “the Government of the United States, through the Bureau of Labor Statistical Department, interviewed over 25,000 families in thirty-three states of the Union. The investigation was limited to the families of persons whose salaries did not exceed \$1,200 a year. The 25,000 families involved 125,000 people, the average family being five.

“My wife figured out that we were buying too much of some things and too little of others—taking into consideration the amount of nutriment to be had for the money. She devised a table of her own showing the comparative costs and calories of the staples.

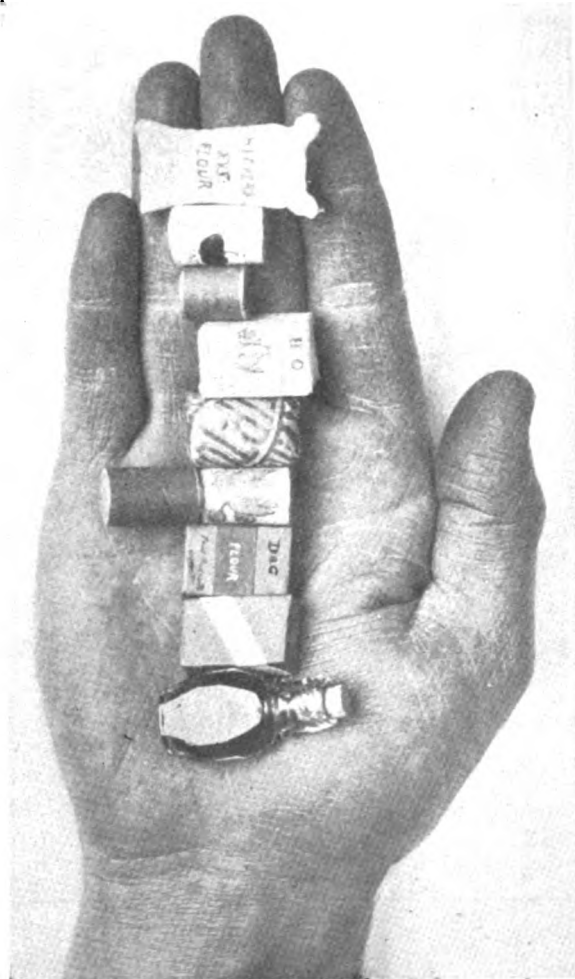

A Photomicrograph You Ask? No, This is Simply Our Conception of How the Grocer's Delivered Order Looks to the Average Man Nowadays in These Days When Onions Are As Pearls.

Article	Average Quantity per Workingman's Family of Food Consumed in 1 Yr.	Average Cost per Workingman's Family of Principal Articles of Food	Relative Value in Nutritional Calories
Fresh beef	349.7 lbs.	\$50.05	1531
Salt beef	48.6 "	5.26	161
Fresh hog products	114.3 "	14.02	429
Salt hog products	110.5 "	13.89	425
Other meat	77.7 "	9.78	299
Poultry	67.7 "	9.49	290
Fish	79.9 "	8.01	245
Eggs	85.2 doz.	16.79	514
Milk	354.5 qts.	21.32	652
Butter	117.1 lbs.	28.76	880
Cheese	16.0 "	2.62	80
Lard	84.4 "	9.35	286
Tea	10.6 "	5.30	162
Coffee	46.8 "	10.74	328
Sugar	268.5 "	15.76	482
Molasses	3.6 gals.	1.69	52
Flour and meal	680.8 lbs.	16.76	513
Bread	252.7 loaves	12.44	381
Rice	25.1 lbs.	2.05	63
Potatoes	14.7 bu.	12.93	395
Cost of total		\$267.01

Food	Price	Amount	Calories
Milk	\$1.25	15.6 quarts	9,628
Meat	1.00	5 pounds lean meat	2,440
Bread	.70	11 pounds	12,680
Butter	.50	1½ pounds	4,654
Eggs	.50	17 eggs	1,275
Sugar	.35	4½ pounds	8,165
Potatoes	.35	8 pounds net	2,816
Oranges	.30	1 doz., fair-size, ¼ waste	594
Cereal	.15	1 pound	1,769
Rice	.10	1 pound	1,587
Macaroni	.10	1 pound	1,587
Incidentals	.70		3,175

"Look at rice and macaroni. A pound of either furnishes almost five times as much fuel value to the body as potatoes and yet costs only about twice as much per pound. Now, rice contains more strength-giving material than potatoes and can be used in place of potatoes. Potatoes are three-quarters water while rice has practically no water. Potatoes are one-fifth starch, while rice is more than three-quarters starch, and starch gives heat and strength to the body.

"Rice contains two-thirds more flesh-building material than potatoes. Therefore, a given amount of money will buy two or possibly three times as much food value if spent for rice as it will if spent for potatoes. If used with cheese, peas, beans or lentils, rice will give you practically all the food your body needs.

"Do you like cheese? Beans? If you do and don't have them very often, you're overlooking some mighty efficient and economical foods. My wife's prowlings in the hygiene books led her to lay down the following dogma on the lesser-used foodstuffs:

"Cheese contains the same flesh-building material as meat and can be used in place of meat and, while the price of cheese has gone up of late, only a very small quantity is needed, if combined with rice or macaroni, to make a dish that will take the place of both meat and potatoes, or take the vegetables which are rich in nitrogen. Peas, beans and lentils are rich in flesh-building material and when combined with rice in an appetizing way will take the place of both meat and potatoes.

"Many people do not like rice. This is largely because they do not know how to cook it properly or how to combine it with other foods so as to make it taste good.

"You understand, I don't suggest the eating of rice in place of *all* other foods, but the cost of living can be greatly reduced by using rice in place of potatoes, and by using rice combined with cheese, peas, beans or lentils in place of both meat and potatoes. This we proved to our own financial satisfaction.

"Then, too, there are big savings possibly by searching around for substitutes for popular foods. The white beans that you generally use now cost about fifteen cents a pound. But you can buy the Brazilian brown beans for eight cents a pound. These brown beans are extremely nutritious, and can take the place of white beans in every way. They are about the same size as the white beans, taste the same, and are pinkish brown in color.

"And by the way, do you realize that beans are richer in flesh-building material than any other vegetable, and can be used in place of meat. A dish of baked beans costing about twelve cents will furnish a family of six with more nourishment than two pounds of beef.

Food	Amount
Codfish	1 pound
Eggs	1 dozen
Butterine	1½ pounds
Cheese	½ pound
Bread	12 pounds (10 loaves)
Oatmeal	3 pounds
Macaroni	1 pound
Rice	1 pound
Sugar	3½ pounds
Beans	2 pounds
Carrots	4 pounds
Onions	4 pounds
Potatoes	15 pounds
Tomatoes	1 pound
Apples	4 pounds
Prunes	2 pounds
Dates	1 pound
Cocoa	½ pound
Coffee	½ pound
Tea	¼ pound
Chuck steak	2 pounds
Flank beef	2 pounds
Milk	14 quarts

Especially Cheap in View of the High Nutritive Value. This Menu for a Family of 5 for One Week Was Found to be Ample to Keep Every One in Excellent Health. Could You Worry Along On It? The Head of the Family Earned \$16.00 a Week.

The young man certainly knew more about food values than I had ever dreamed existed, and a good deal of what he said impressed me. But it struck me that he was a bit too scientific in his dealings with such an essentially human thing as a stomach, so I said:

"That's all right, I dare say, and I haven't a doubt but that I could cut down our food bills by following out your suggestions. But man, when I lay out dollars and cents I like to buy taste with them—not just calories and nutritive values. I'd shudder to think of abandoning the good old spuds for your Brazilian beans or plain, tasteless boiled rice. I'd hate—"

"Yes, I know," he said, "but try it first. I had the same theory until I learned that there were at least thirty different ways of cooking rice. You can't cut your living cost without any trouble at all; you've got to at least experi-

ment until you find a form that pleases your palate. Why, you speak of tasteless rice and ridicule assorted vegetables in place of meat, but do you stop to think that the Chinese restaurants can add a flavor of chicken or other meat to one of these so-called 'vegetable stews' and make people clap their hands over it!

"I'm off at the next station," he said, "so the ordeal's over." Then he added:

"I suppose you don't think I get any joy out of eating under such a system. Well, I do; and if you'll give it a fair chance, you will."

He got off. The vision of four prunes, price fifteen cents, floated before me and brought back the H. C. L.

I should not have liked to have had him know it, but I was already figuring that I would delve a little deeper into calories and their effect on the H. C. L.

The General Sales Committee Has a Dinner

IF you are a member of the General Sales Committee, or if you were one of the guests at their Ninth Annual Dinner on March 8th, you know exactly how a soldier in the trenches feels when a big enemy aeroplane sails overhead, dropping bombs in his general direction in the earnest hope that one of them may blow him and a lot of his friends to another location.

The aeroplane was there all right, and it certainly did buzz around the room industriously; much to the amusement of all; until Billy Leigh hitched to it a mysterious contraption that looked like a lot of short pieces of small sized lead pipe; even that was taken calmly. But when like a regular villain, he proceeded to light a fuse that stuck out of the end of it, there was some misgiving even in the minds of those who have known Billy for a long time.

The plane with its sputtering fuse hadn't gone half way round the table before the little pieces of lead pipe, pre-

sumably containing shrapnel, began to fall on the wicked and the righteous indiscriminately. Bear-cat Fletcher, the leader of the orchestra, and his dusky assistants, just naturally faded away and it took all of Mark Curran's persuasive powers to get them out from under the piano.

Well, when it developed that the bombs were nothing more dangerous than cigars and cigarettes done up in silver paper, every one was perfectly willing to have the bombardment keep up all night.

The fact that later in the evening the aeroplane was brought down in flames, made it more realistic, although this feature was not a part of the committee's plan, they having borrowed the "plane" with a guarantee to return it in good order.

There were a lot of good songs and some very high-class amateur singing. The committee tried a new stunt very successfully; instead of giving the diners a book of songs, they were thrown on a screen and in that way came as a surprise to everybody.

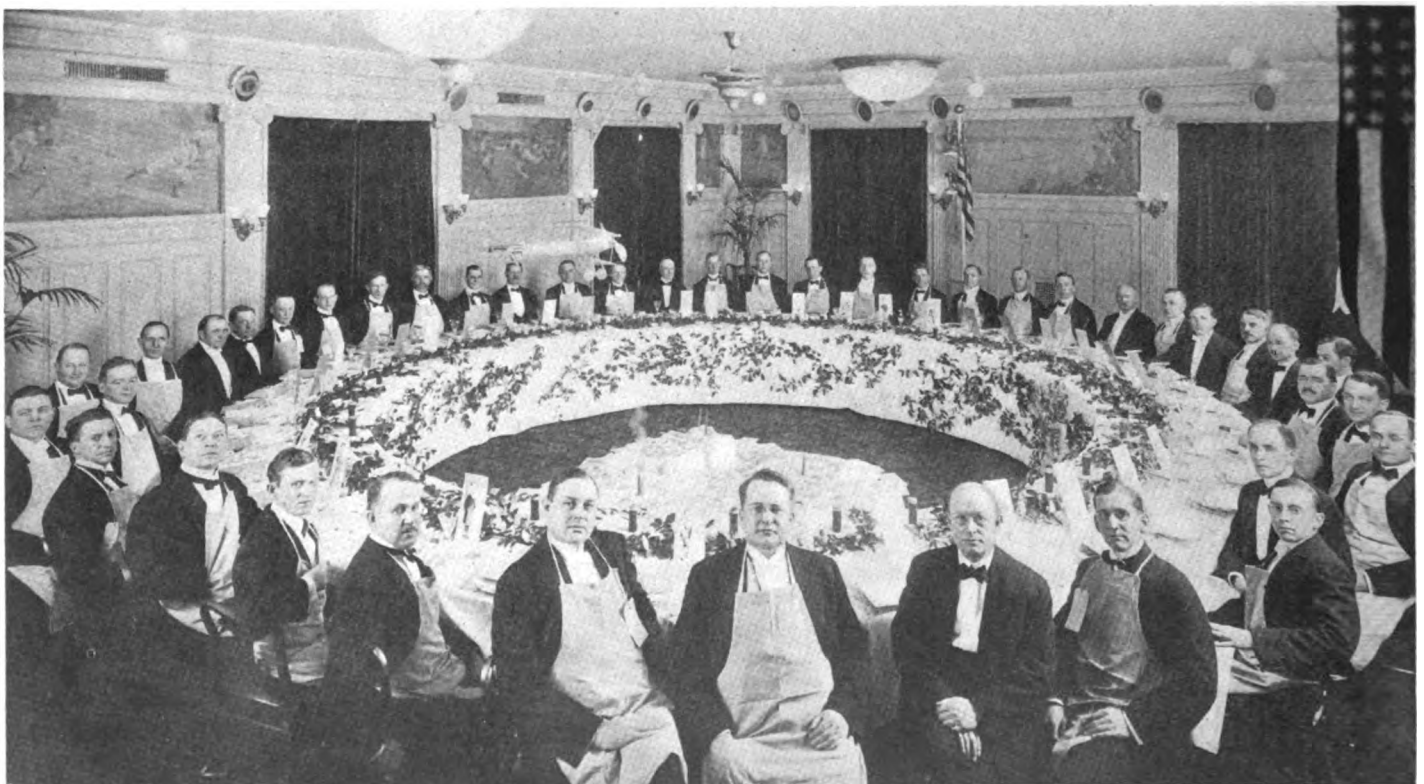

The General Sales Committee and Its Guests—In Banquet Assembled

Just as Mr. Swope was settling down comfortably to digest his dinner, a gigantic birthday cake with nine candles was set before him; he was kept fairly busy cutting it into forty-two pieces of exactly equal size, to the accompaniment of that touching old ballad—"Everybody Works but Father."

Just to show our guests how much we appreciated their being there, they were allowed to make all the speeches and we must admit they did their part willingly and gracefully.

Cartoons of the diners were used as place cards and unless one recognized his own likeness, he was likely not to get any dinner; needless to say, it developed that each man was surprisingly familiar with his own features. A few of the cartoons are reproduced here.

There aren't any legal holidays in March, but so long as we continue to have the annual General Sales Committee dinner in that month—we should worry.



TO A. L. SALT AND J. W. JOHNSTON
(Tune: *Sailing — Sailing.*)

"Selling—selling,"
Al said to Jim one day,
"Is easy when we are on the job
"To sort of light the way."
"Selling—selling,
"With us to pull the string,
"Why even a bonehead salesman can
"Sell almost anything."

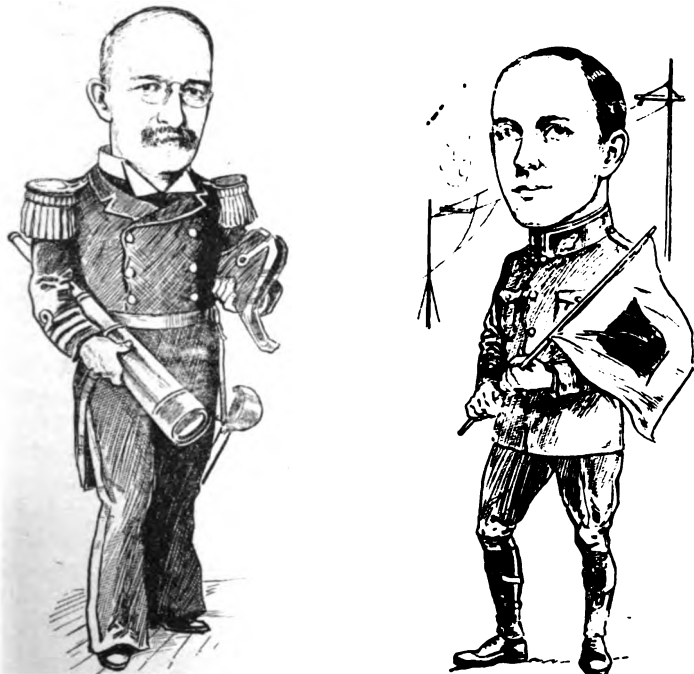

TO H. B. THAYER

(Tune: *Hello, I've Been Looking for You.*)

Hello, we've been looking for you—
Hello, can it really be you?
The last two years we've looked in vain
And it's good to see you again.
Hello, this is quite a surprise,
Hello, you're a sight for sore eyes.
We are pleased to see you, sir;
Glad to greet you, sir.
And we'll give you three cheers,
Hello,
We've been looking for you
For the last two years.

TO F. B. JEWETT

(Tune: *I Didn't Raise My Boy to Be a Soldier.*)

We didn't raise F. B. to be a soldier,
At Engineering he's our pride and joy.
Since Uncle Sam put straps upon his shoulder,
We give three cheers, for we know he's the boy
To run his Country's signals where they're needed,
To flash the word to any land or sea;
We shout Old Scout go to it—
We're with you Major Jewett,
You'll surely make a dandy little soldier.

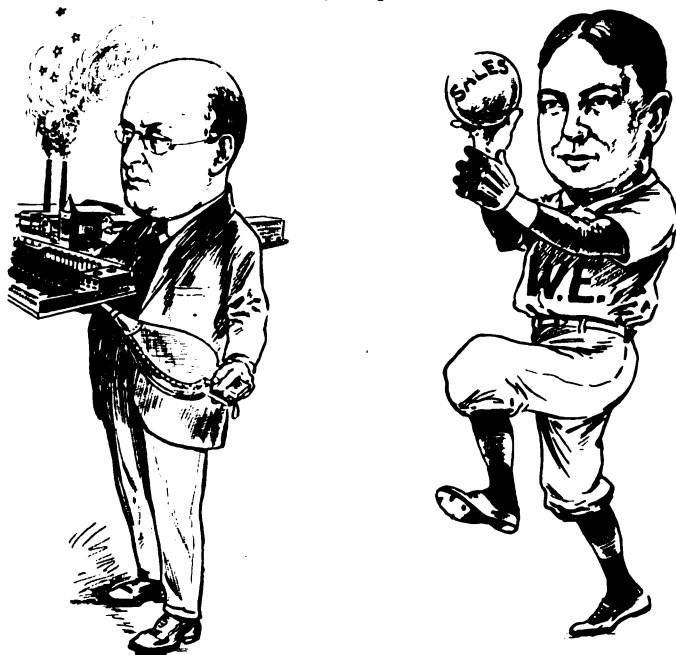

TO H. F. ALBRIGHT

(Tune: *Oh Promise Me.*)

Oh promise me that some day soon there'll be
More material to send through this Country;
More switchboards, more cable, and more phones,
More than we've ever seen before.
Our customers are getting very fierce and wild,
Oh, Albright, won't you save our darling Child?
Have a heart, and heed this aching plea—
Oh promise me, Oh promise me.

TO E. W. ROCKAFELLOW

(Tune: *Take Me Out to the Ball Game.*)

I can't get to the golf links,
I've got too much to do.
Budgets, committees and sales campaigns—
Not a day comes but there's something new.
Martin tells me all of his troubles,
Hawkins and King do the same;
Then Phil Thomson and Bill
Some of their hot air spill—
That's why I can't get a game.



TO H. A. H.

(Tune: *School Days.*)

War days,
War days,
Oh, you hustling war days.
Orders from North, East and South and West,
Keep me from getting my well-earned rest.
I stay awake most every night,
Trying to keep the balance right—
'Twixt supply and demand
There's not much light;
They step right on each other's heels.

TO O. D. STREET

(Tune: *Every Little Movement Has a Meaning All Its Own.*)

Every little order that does not exceed three bones,
Makes Dick Street emit a lot of awful, dismal groans.
There grows within him a fearful feeling
That expenses will hit the ceiling,
So you'll soon hear some fancy squealing
When the retail price starts to rise.

TO R. H. GREGORY

(Tune: *School Days.*)

Closing, closing,
Closing days are over.
I heave a sigh of relief at last,
Closing-up book-time against is past.
Telegrams, letters from everywhere,
Help to turn gray the last of my hair—
Of closing-up figures, I've had my share
'Till nineteen-eighteen comes around.



TO GERARD SWOPE

(Tune: *Captain Jinks.*)

I'm Captain Swope of the Sales Commit',
I run this good electric ship,
I drive my men with the crack of the whip,
I'm Captain Swope of the Western.

CHORUS

Zip, bang, away we go,
More coal, steam's low,
More speed—not so slow,
That's the way I test 'em.

TO W. P. SIDLEY

(Tune: *The Stein Song.*)

Give a rouse then every day, lads
For we have no jails to fear;
Pa Sidley's on the job, lads
With the cops way in the rear.
For it's always fair weather,
While Bill holds on to the tether,
With something up his sleeve, lads
And his G. I.'s ringing clear.
So we don't care whether
Singly or all together
In the pen he should find us—
He will quickly get us clear.



AMONG THE ENGINEERS



NEWS OF THE DEPARTMENT FROM NEW YORK AND HAWTHORNE

New York

K. Bungerz, Correspondent

A mummified rat was discovered in the wall of that part of the thirteenth floor recently vacated by the Comptroller's Department. The rat evidently died waiting for the approval of an expense voucher.

WHY THE PRIVATE WIRE IS OVERLOADED

We quote the following jewel from a Hawthorne telegram as received at New York:

"Refer our letter . . . reference to Nos. 577 and 572 cords should be 577 and 572 cords."

Recently a number of the engineers in the Semi-Mechanical Branch were working overtime. About eight o'clock a much perturbed young lady stuck her head through the door and besought help in opening her locker. She had the key, but it would not work. Sixteen gallant engineers immediately offered to make that key work or know the reason why. All sixteen failed to make it work, and also found out the reason why. After numerous attempts it was decided to call the factory engineer. No greater success. A 15-inch screw-driver was pressed into service and the "Jimmy Valentine" stunt began. The locker was pried open top and bottom and only the middle lock remained to be jimmed. Suddenly the young lady's enthusiasm about getting that locker open waned and she remembered that her clothes were not in that particular coop.

Moral (for the special benefit of the B. and M. Branch): Stamp locker keys to correspond with locker numbers.

One would imagine, one would, that after spilling a page or so about the new organization chart P. R. Goodwin would come across with some visible evidence of his efforts. As the matter stands, there is a reward of no mean

value offered to any one who has seen the chart out of captivity.

If Hawthorne wants to get some fun out of weddings in the cable plant why not comment on the fact that with one exception all of the weddings reported in last month's NEWS involved employees in department 7381.

The height of uselessness—The "Up" light for the thirteenth floor on the front elevators.

A suggestion from the girls—Install one winch to drag stenographers from Washington Street to West Street in the face of a gale.

P. M. Rainey evidently believes that, although the Company did lots of business last year, it is, nevertheless, worth while to save a penny wherever possible. His annual photographic pass shows him wearing a moustache. Since the photograph was taken, P. M. had the adornment shaved off. Now that the pass question is becoming acute, he has decided to let his moustache grow rather than get into trouble with the watchman, and also, as has been said, to save money for the Company.

ENGINEERING DEFINITION

Doors—Things, no two of which swing in the same direction in the Engineering Department.

In the February issue of the NEWS, in the article describing the illumination of the Niagara Falls, reference is made to electricity as the "artificial wonder of the age." Why didn't the author say?: "The natural successor of that antiquated form of artificial energy—steam."



Speaking of Passes, the Girls had their Photographs Taken as Shown in Figure 1. They Come to Work a la Figures 2 and 3. What Good, Say We, is the Pass?

AROUND THE CIRCUIT

GOSSIP GATHERED BY THE DISTRIBUTING HOUSE CORRESPONDENTS

Cleveland

W. F. Quirk, Correspondent

MOVING

Soamtimes it helps a lot
 If you kan jest stan up
 On youer hind legs
 And cus.
 If you workit for a big
 Corperashun and they had two offices
 On diferant floors
 In one building
 And there hadn't ought to be
 More than one office
 Becaus it's too crowdit
 And becaus the ventilashun
 Is so you hav to chew it
 Befoar the air will go down.
 Then when you get all your
 Plans lade out and
 Know to a nat's heel just
 How and when and where you
 Are at all the time and
 Figger they can't fool you mutch.
 Then to find out that every
 Supplier in America musta
 Knowed about your move and
 Tride to ship you all the stuff
 You had orderit for ten mo.
 Back and more, too,
 And fill your wearhous to the
 Ruf and then some
 And you find out that all carpenters
 Is got hookworm and got it bad
 And all painters must a got
 Writer's cramps in both hans
 And all the plummers and
 Electricionists—(there's the life)
 And then when it's done—my
 My—who maid them estimates?
 Then comes the Nuze and you
 See what fancy schedules they
 Made in there moves down to
 Leguminville and Moneytown
 And you are stil dreeming
 At nite about what you can do
 Nex day with the nex carload
 Some body's going to ship you
 And when you get all done and
 Set down to rest and maybe feel
 Sorry for yourself some frend
 Comes in and says, "What made it
 Cost so much?" (they say he
 Will recover out to the Hospital).

New York

H. H. Gamble, Correspondent

THE ANNUAL DINNER

On February 28th there was held, at the Hotel Astor, the very best banquet any Western Electric Distributing House ever held, not even excepting Chicago's 1917 "affair" which consumed a solid three pages of the March NEWS.

There were two hundred and twenty-seven of us, all told, including the General Sales Committee as guests. We wanted them with us because of the proximity of March 31st.

At seven o'clock the common rabble and Mr. Templin marched in in lockstep—practice was not needed—to the tune of "Pretty Baby." After being seated, and before we could reach for our spoons, all lights went out, a searchlight shot across the room, and from the far corner there came an "honest to goodness" aeroplane all be-decked with electric lights, featuring an American flag. It was the product of "King" Cole, and upon being complimented for his good work, he said it was "Sew Easy" to make, as he used one of our sewing machine motors.

At the end of its flight the machine shot into the smoke clouds out of sight, but soon reappeared bearing a placard inscribed—"Welcome Fred Leggett." On its return trip, the placard had changed to—"Look out Chicago, We'll Leggett and Ketcham"—(Chicago papers please copy).

Between courses we were treated to some real talent, par excellence, from entirely within the Company. H. M. Gladstone (Methods Department) demonstrated thoroughly to the Cashier's Department that he was the one man whom they had to fear. His sleight-of-hand exhibition was suspected of being professional—it was so good.

Messrs. Craig and Evans, of the Claim Department, settled some long outstanding claims with their superiors, and with a long list of comic verses, each one funnier than its predecessor, sang just what they wanted to about them. "Come Unto Me and Rest" Elmondorf delivered his sermon in true ministerial manner and in such a



Omaha

M. A. Buehler, Correspondent

Behold the "Two Hundred Club" of Omaha! They loaf not, neither do they lose out on sales—and yet we say unto you that Bill Taft in all his heftiness is not arrayed (in fleshly substance) like one of these.

Oh! yes, that is a little exaggerated, of course, but you get what we mean: each is over 200 pounds. From left to right—M. A. Buehler, E. Lum, W. Van Shaik, H. N. Goodell, H. A. Shaben, A. H. Bannister, A. G. Henning and D. F. Roseborough.

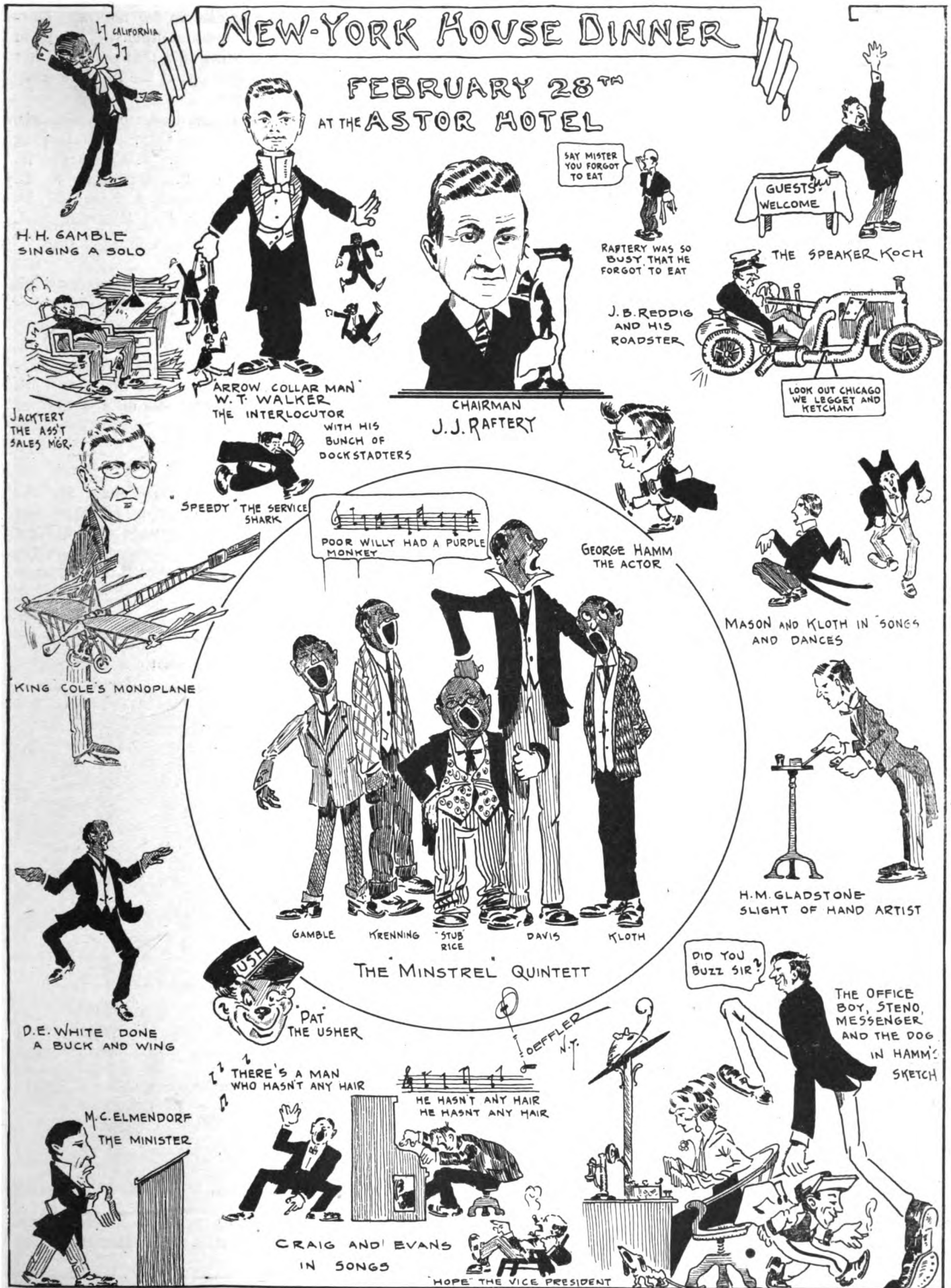

touching way that C. Ed. Fee offered to give old Mother Hubbard the bone so ardently desired.

G. B. Hamm and his troupe, of the Voucher Department, pulled off a sketch called "A Mile a Minute Manager," the hero being "Mr. Gerald Hope." It explained clearly not only how all the higher-up jobs are obtained, but also retained.

The festivities were brought to a close by our Hart, Schaffner & Marx representative, W. T. Walker, as interlocutor to twelve colored "gen'men" comprising a minstrel show.

The organization is much indebted to you, Mr. Raftery and your committee for a most enjoyable evening, and if public opinion is any criterion, no one would be disappointed if next year sees you again selected to arrange the banquet.

Married—Ralph Jacktery and Miss Helen Hurry, Hotel Astor, February 28th, 11:30 p. m. Marriage ceremony performed by the Rev. Nebuchadnezzar Elmendorf. Witnesses: Ima Ham and Gerald Hope.

The new correspondent is delighted at the fine co-operation accorded him by all departments, especially Newark, Buffalo and New Haven, but he is somewhat at a loss to imagine why everybody is using invisible ink for their contributions. It is so hard on the eyes.

Since Jack O'Donnell has been selling farm lighting plants, his actions are not those that befit a married man. It is said that he goes up State for no other purpose than to get the farmers "lit up."

Following is only a part of the description of the Chicago Sales Dinner, as taken from the March NEWS: "Noted for its originality, pep, humor, dash, interest, inspiration, vigor, decorum, good fellowship and a record breaker." Ten adjectives all in a row—count 'em ladies and gentlemen—ten—and paper costing as high as it does to-day. Wouldn't it have been better (and cheaper) to say that the dinner this year *OUTRANKED* them all, and that the Hawaiian Octette was a *HOWLING* success?

PLACES BEING GUARDED

Prisons, asylums and the Engineering Department. The latter has lately developed a great sense of humor.

W. Woessner has been accused of being a hard worker, for no other reason than nearly every night he takes home a portfolio. Recently a new watchman, who did not know him, demanded to see what he was taking home. The watchman reported that it was laundry.

J. B. Reddig has been traveling extensively during the past month, judging by the suit case plastered all over with labels from foreign countries, which he has brazenly carried to and from the office. We understand the Export Department carries these labels in stock.

During the practicing for the minstrel show, the star end man, G. C. Krenning, did not see the point of one of his own jokes. It was on Bert Hawkins, who was trying to sell a farm lighting plant to a farmer who replied that he would like one of them there plants but guessed he

could get seeds from his Congressman for nothing. During the final rehearsal G. K. insisted upon saying farm outfits, and it was only upon being told that seeds did not grow into "outfits" but into plants, that the light dawned.

At the rejuvenation of the Jovian Order on March 9th, in the Machinery Club, New York City, the following Western Electric men were initiated: J. C. Mazon, H. H. Gamble, C. K. Brackett, B. P. Martinson, E. E. Higgins, H. H. Binder, J. M. O'Donnell, A. Kirby, W. D. Koch, J. V. Guilfoyle, W. T. Walker, J. C. Hildreth, A. J. Gallager and G. C. Krenning.

In order to give better service to our customers, both in New York and Newark, we have purchased two one-ton Republic Trucks.

It is of interest to note that there were seventeen carloads of telephone equipment consigned to the New York House for use in its A and B business on the first of March. In normal times we have from two to three cars *en route* at the same time.

On account of the necessity for more space for the Engineering Department we are moving some of our warehouse work to rented quarters outside of the West Street building and will re-locate the Stores offices on the fourth and fifth floors. It is expected that this rearrangement will take place this month.

Boston

D. A. Chase, Correspondent

Moriarty's Message

There was an old woman
Who lived in a shoe;
The woman was old,
But the story is new.
Alas! the poor woman
Was not very strong,
And her kids kept her working
The whole day long.
Bill tore his pants,
And Mary her dress;
John needed shirts,
And Nellie—well guess!
Frank ripped his collar,
And Bessie her waist,
So the woman kept working
With feverish haste.
And as soon as she thought
That her sewing was done,
More work was demanded
By daughter or son.
But now she is happy.
She just had to get
A sewing machine. A "WESTERN?"
You bet!

Western Electric Sewing Machines, \$35
Portable, Compact, Standard Attachments
Western Electric Sewing Machine
Motors, \$15.00
To be attached to any make sewing machine

THE MORIARTY ELECTRIC SHOP
15 Lunenburg St. Tel. 993-W

Verse is usually a rather dangerous kind of advertising, but we think this newspaper "ad" of the Moriarty Shop gets by—to say the least.

Chicago

R. F. Young, Correspondent

TO THE BOARD OF EDITORS

All the friends that I have—I can speak for the gang—
Get their rations of cheer from the NEWS.
The rest of the papers and books may go hang,
But they swear by the stuff you diffuse.

There's Barron in Clinton and Mike in Des Moines,
And Hillis somewhere on the lope;
In Kokomo, Gilbert; in Bloomington, Holmes;
And Lightfoot in Rockford, I hope.

In Joliet, Poggi; in Waterloo, Brooks;
And Schwenck down in Kalamazoo—
Await every issue with envious looks,
To see what has happened that's new.

And so, Esteemed Sirs, when my stuff you let pass,
(Strict censorship long may you waive)
I'm writing a letter to these friends, *en masse*,
And—look at the postage I save!

—W. M. G.

Our organization at Detroit was somewhat upset on the morning of March 10th when the following item appeared in one of the Detroit papers:

"The Western Electric Company of Detroit filed a voluntary petition in bankruptcy in the United States Court yesterday, showing liabilities of \$31,467.00 and assets of \$2,542.00."

Our employees, there, got their pay the same day as

usual, which somewhat allayed their fears, and a little later in the day it was learned that our name had been printed through a typographical error.

Class in pro-nun'ci-á-tion (get that) will please arise!
We will be ad-dressed to-day by E. R. Gíl'more, As-sís-tant Treá-sur-er, at Chi-cá-go, who lives in the high-brow súb'urb of Ev'an-ston. Mr. Gíl'more has chosen for to-dáy's lesson the four words, most cóm'mon-ly mís'pro-nounced', in the e-léc'tri-cal vo-cab'ula-ry. Here they are with the dic'tion-a-ry or cor-réct' pro-nun'ci-á-tion and the fa-míl'iar e-léc'tri-cal way of express'ing them.

<i>Dictionary</i>	<i>Electrical</i>
Cón-dit	Con-doó'it
De-tails	De'tails
In-quí-ry	Inqur'ry
Con-tráct-or	Con'tractor

A NEW FORD STORY GUARANTEED ABSOLUTELY ORIGINAL

L. T. Milnor, Cincinnati Manager; B. S. Culp, Chicago Stores Manager, and W. J. Speer, Chicago Storekeeper, were riding around the other day with Joe West, Cleveland Storekeeper, in Joe's new Flivver.

Mr. Milnor ventured the information that the engine on the new model Ford was not as noisy as formerly.

"That so?" said Mr. Culp, who has always been an ardent Forditest. "How is that?"

"Well, you see," resumed Mr. Milnor, "It does not have a brass band on the radiator now."

P. S.—Come on fellows! We know what you are going

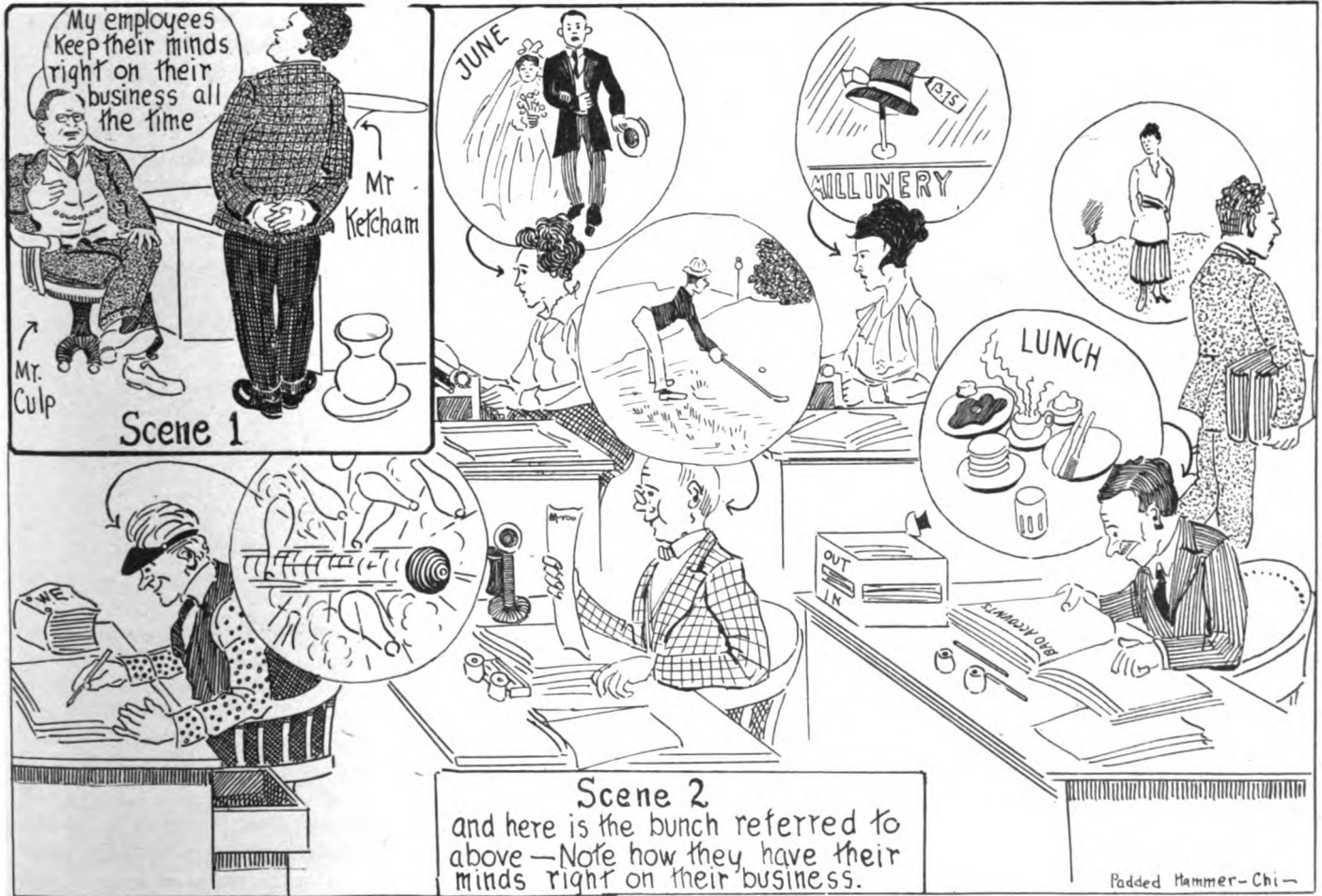

to say. You are going to declare that the above joke is so old, that its use has been made a misdemeanor in Pittsburgh and St. Louis.

F. H. Van Gorder, Sales Manager at Detroit, recently figured in a little mystery—ahem—which might be entitled—ahem—"The Tale of a Night Shirt."

While stopping at the Brevoort Hotel, on the occasion of the Chicago Sales Conference, Mr. Van Gorder's *robe-de-nuit* disappeared and Mr. Adams, the manager of the hotel, gave him \$2.25 in replacement. On the night of the banquet, so Mr. Van Gorder testifies, he was informed by Jim Bateman, Cleveland Manager, that the—pardon me—*mentioned* garment had been found and would be forwarded to him at Detroit. Van returned the \$2.25 to Mr. Bateman with instructions to give it back to Mr. Adams.

Then—ahem—night shirt, on its arrival at Detroit was found to be an "alibi" that had been picked out of the rag-bag, according to Mr. Van Gorder, and he straightway consigned it to the waste paper basket. Now Van is wondering whether to make Mr. Bateman or Mr. Adams the party of the first part in his claim. He knows that he is out \$2.25 that he had right in his hands once.



Rollo C. Kearsley, Chicago Sales Department.

some of you might suspect.

While his length of service is interesting, it is not the reason for publishing his picture here. You will note that Mr. Kearsley is holding in his hand a folded document.

That document represents the largest single order for Sunbeam Lamps ever secured by the Western Electric Company and the order was taken by Mr. Kearsley.

The net valuation of the order is \$44,100 and it calls for 834 cases of Sunbeam Mazda C Street service lamps.

We are all good soldiers at Chicago, but being only human, when we get a little testimonial like the following, we feel like bowing in three different directions and saying thank you, thank you, thank you:

Here you see a picture of Rollo C. Kearsley, City Salesman at Chicago. On April 1st, Mr. Kearsley had been with the Company 29 years and 9 months. Rollo did not jump out of the cradle, when his mother had her back turned, and start on a run for the offices of Western Electric Company to apply for a job there, as

"Please allow me to extend my thanks and appreciation for the quick response and cooperation of your people in furnishing emergency switchboard equipment for the C. B. & Q. freight headquarters at 16th & Canal Streets after their building had been destroyed by fire on the night of February 27th.

"Your Mr. Griffin was called about 1 A. M. on February 28th by Mr. Hyatt, and within four hours a two-position switchboard, with twenty-five telephone sets, was delivered to the job before the Railroad Company had decided on a temporary location.

"This is not an unusual case, but just one more instance which proves that the Bell System realizes its responsibilities to the public and especially to other public serving companies.

(Signed) V. RAY,

Maintenance Superintendent.

Chicago Telephone Company.

SUNG WITH A VIGOR AT CHICAGO'S BIG DINNER LAST MONTH

ASK DAD, HE KNOWS

Air: Casey Jones

Come all you sinners if you want to hear
Of the trials and tribulations of "SPEED KING
SPEER."

At STERLING, ILLINOIS, he first saw the light,
About the time old "BEN" got juice from a kite.
Ask anybody and I'm sure they'll agree
He must be all of a hundred and three;
But let me tell you "BO," I've got to say,
He's certainly getting younger day by day.

Chorus

Cappy Speer, he's a Grand Old Party,
Cappy Speer, always full of cheer,
Cappy Speer, never does get older,
In fact, I think he's getting younger every year.

Fate dealt him a name that rhymes with beer,
But the only kind he touches is a brew called 'near;
"Ask Dad, He Knows" that smokin' is the bunk,
And if had his way he'd put the cussers in the junk.
GAWF is an affliction that's peculiar to the Scotch.
And the game "DAD" plays is surely top-notch;
He always saves the honor of the W. E.,
While GRANT upholds our prestige from the TEE to
the TEA.

Chorus

Cappy Speer, a thorough prohibitionist,
Cappy Speer, always workin' hard;
Cappy Speer, he plays a corkin' game of golf,
And always tells the truth on his little score card.

Pittsburgh

J. B. Stafford, Correspondent

Last week Mr. Wasserman, of our Service Department, called together the boys of our office under eighteen and suggested that they organize a club. The boys thinking this was a very good suggestion, held a meeting on Friday, February 16th, at which time they elected a president, secretary and treasurer. A lot of enthusiasm was aroused, and we contemplate making the club a howling success. The object is to abolish uncalled for habits, such as the use of tobacco, bad language, etc., and create good fellowship. We expect to have a few teams, such as baseball, football, basketball and swimming. We have some very good men and expect to trim the teams of some of our

customers. We have one boy under seventeen years of age who only weighs 225 pounds. He will make a fine umpire. We have secured a good athletic field near the office and two of the older men have offered their services as coaches.

The club was named "Weco" by taking the letters W. E. Co.* We regret that there is no opportunity of playing the teams of other W. E. houses, as we think we could make them hustle.

* We don't follow you.—Ed.

Some of you may think *Us Kids is too fresh*, but watch us grow. You'll hear from us in the NEWS every month.† Maybe. We try everything once.—Ed.

Dallas

S. Zercher, Correspondent

We reproduce a photograph of an Eveready Flashlight Window used by Titcher-Goettinger Company, a big department store of Dallas, during the big Eveready drive last October. This window took second prize among cities of 100,000 and over population. The mechanical features were arranged by B. E. Chivens, of the Western Electric Company, and were as follows:

The setting was a rapid firing gun being operated by one of Uncle Sam's boys. At the breech of the gun was a belt about four inches wide on which was mounted eight No. 2602 E. R. flashlights. The portion of the belt which could be seen was moving upward and at such a speed that the flashlights or

(shells) raised a shutter and disappeared into the gun at the rate of about twenty per minute.

About six inches in front of the muzzle of the gun could be seen another No. 2602 E. R. flashlight mounted on a string or belt. This belt was running at such a speed that each time a shell disappeared into the breech of the gun, one shot out at the muzzle and disappeared in the brush in the corner of the window. A light was so located inside the barrel that just as the flashlight or (shell) shot out of the gun a flash of light was seen from the muzzle. The figure held a No. 2659 flashlight in his right hand and this kept flashing on and off.

The floor of the window was covered with sand and the background of brush with Mexican cactus around the roots.



Here is Ross D. Cummings making the speech that won the prize at our Sales Conference in February. Doubtless you will recognize the attentive listeners as B. W. Van Valkenburgh, Manager; P. L. Thompson, Advertising Manager, and W. J. Drury, Sales Manager



The Militaristic Flashlight Display in a Dallas Store Window. Designed by a Western Electric Man



NEWS FROM HEADQUARTERS

Some Items of Interest from the General Departments



General Sales Department

W. A. Wolff, Correspondent

STRANGE? NOT AT ALL
(Replying to W. M. G.)

Dear friends from Chicago, we're sorry
That nothing we write seems to stick.
That when it is read—
Zip! Out of your head
It goes like the shade of Old Nick.

But, list. We've a very good reason
For writing our stuff in that mode.
We would rather you'd not
Recall e'en a jot.
That you don't, rids our mind of a load.

Once, when we were young and unmarried
And could write dainty verse to a maid,
We indited a beaut',
That bore bitter fruit
Of the species that makes lemonade.

'Twas conceived as a valentine ditty,
In a spirit of fun it was writ;
But cursed was our luck,
One line of it stuck—
The maid, alack, saw not the wit.

For aeons and aeons long after,
That line came back home very oft.
Ne'er boomerang flew
More sure nor more true,
And the landing, my friends, wasn't soft.

So we'll not write posterity's poems.
If your memory you're anxious to whet
Get Kipling or Noyes
Or some one of those boys.
Our jingles? Well, read and forget.

—W. A. W.

MUST HAVE BEEN A TEMPEST IN A TEAPOT!

Des Moines wrote C. A. Merrill, our new service manager, an urgent appeal for a lot of No. 19 inside wire, and just to make it strong they said:

"Rush delivery account of storm troubles."

Charlie says that even if he is new on the job he knows which side of a house storms usually hit.

AN APPRECIATION

When we look at some of the cartoons that emanate from Chicago, particularly those satirizing so subtly the characteristics of Bert Hawkins, Bill Schnedler and J. F. Sweeney, our memory goes back to an old story.

A woman in widow's weeds comes to a painter to have a portrait of her late lamented painted. She had no photograph, so described the deceased to the artist. A month later she was called in to view the work. She burst into tears. The artist, flattered, said he was touched by her appreciation. "That isn't it," wailed the relit, "I'm crying because Jim has changed so."

PUT YOUR OWN CONSTRUCTION ON THIS

That little paragraph that appeared in the March issue, where the editorials have heretofore scintillated, makes us think of Jimmie in the play "Bought and Paid For" who, when asked how he liked the opera, replied: "Do you want my real opinion, or am I talking for publication?"

WE PAUSE FOR A REPLY

We often wonder just what it is that keeps Marcus Aurelius Curran—the apostle of Baked Alaska, than which there is no dessert that is whicher—from wearing an honest-to-goodness wide ribbon on his pince-nez instead of a dinky little string. Is it fear of what people would say, or is it a lack of knowledge of what the best people are doing?

TAKE 'EM AWAY

Banquet pictures!

As Bunker Bean said: "I can imagine nothing of less consequence." Oh, ye editors, an' you seek suggestions, let us have no more views of twenty to two hundred sad faced humans seated about a "festive board."* Let us rather imagine them as we would have them—joyous and well-fed.

* We have several in this issue. See pages 12 and 28.—Ed.

COMING BACK STRONG

Wrote the secretary of the Klaxon Company to E. J. Riley after having missed seeing E. J. at the Auto Show:

"However, you seemed to disappear for when I looked around after speaking to you a minute before you were gone.

"I did not know the Western Electric Company handled electric wings. If you do, put me down for a pair, for I can use them very readily."

And our Irish wit thus replied:

"With reference to the electric wings, I am afraid your experience with horns would disqualify you from wearing wings. However, we are pulling for you."

A Ray of Light Hits St. Louis

W. A. Titus, of the Installation Methods Department, recently spent several tedious days in St. Louis looking for suitable quarters in which to locate a training school for student installers. That sounds all right but we now find among the expense vouchers a suspicious looking bill.

"One Eveready Flash Light Lamp and Battery, 60c—for locating Training School."

We knew that St. Louis burnt soft coal, but we thought they had regular electric lights. Or maybe being a small man he didn't want to chance losing himself. However, the flash lamp did the work for we also find a rent receipt.

—H. J. H., Hawthorne.

HEARD IN THE SHOPS

ACTIVITIES OF THE MANUFACTURING DEPARTMENT AT HAWTHORNE

Who's Who at Hawthorne?



Who's got a bull-frog beat for bull and keeping on the jump? (That hint should penetrate your wool.) Right! George DuPlain is trump.

Who grabbed a job at Clinton Street when Hector was a pup and made it whimper—"Gosh all Pete! Say, have a heart! Let up!" Who ever since has had work's goat? To show that he's a bear he holds two jobs down by the throat. (Quite right, old kid, he's there!) Who insulates and twists up wires 'til nearly time for lunch, then runs and pokes the restaurant fires and feeds the Cable bunch?

Payroll Department Dancing Party

On Tuesday evening, February 27, the payroll department, 5039, held its annual party at Garfield Park Refectory. Each couple was presented with a souvenir card-case and change purse bearing the monogram "P. R." and containing the evening's program. Every one present wore a miniature American flag. At the end of the grand march, which was led by a special detail of National Guardsmen from the Second Regiment, carrying the regiment's flag, all the dancers stood at attention before the flag and sang the "Star Spangled Banner." About eighty couples enjoyed the program.

Judge Him By His Words, Not His Ax. But Oh! Such Language!

There are three separate and distinct explanations of it. One of them is that "Father" Rice was bitten by the bug of ambition. Having long been known as the Father of his Company he became ambitious to take in more territory and go down in history as the father of his country as well. Consequently, a day or so before Washington's Birthday he started out after George's cherry-tree record with an ax. He lost out by a foot—incidentally seriously damaging the architecture of said pedal extremity by a gash as broad as the language he applied to it. Of course, after that there was nothing for him to do but give up. Although he still felt himself to be the logical successor to the Father job vacated by Washington he realized that he couldn't hope to make good as a step-father with his stepping mechanism out of commission.

A second theory is that "Father," while out cutting the morning fodder to feed the furnace, fell to musing over an article on making wooden legs for maimed soldiers, and in his absent-mindedness forgot his own wasn't that kind.

The third contention is that it never happened at all, since "Father" was brought up on a farm and certainly ought to know how to chop wood without cutting his foot.

Now, discarding all theories, these facts are certain: C. L. Rice was away from work several days. When he resumed the superintending of production at the old stand he brought back with him a very decided limp; also such a very decided frown on the subject that asking him how he had hurt his foot soon became recognized as a certain, though very undesirable method of committing suicide.

So there you are. Make the most of it. We are neutral.

Speaking of Telling Phrases

D. A. Wallace, head of the apparatus drafting division, understands how to "keep things under his hat" as well as most men, but he had to confess himself stumped as to the exact degree of secrecy involved in a recent memorandum which referred to one of our manufacturing processes as "semi-secret." "Sandy's" guess on the matter is that a "semi-secret" is one you can tell to anybody you please, provided you make him promise not to repeat it. But here is another possibility: Since "semi" means "half," mightn't a semi-secret be one you share with a friend on a 50-50 basis—each one to keep half. Or perhaps each repeats half, and the secret isn't kept at all. Oh, well! We don't know. Let I. Manutt, the News' repeater expert, settle it.

Afflictions of the Affluent

Gout used to be considered a stylish misfortune, but just listen to this: Our relief department recently received an accident report of an employee who had "infection of finger—possibly from handling money." Probably broke a dollar intending to buy something and then carelessly cut himself on the pieces.

Hawthorne Player Gets into Big League Baseball

John T. Berry, of Department 5039, Hawthorne, has left for the spring training trip of the Washington Baseball Club at Augusta, Ga., with a contract safely tucked away.

Mr. Berry, who is but eighteen years of age, was chosen last summer from a field of 580 participants in the Chicago *Tribune's* try-outs for amateur ball players and as winner went to the world's series games as a guest of Ban Johnson, president of the American League. While on the world's series trip he met Clark Griffith, manager of the Washington Baseball Club, who was so impressed with the youngster that he offered him a contract for the season 1917, which was signed by young Berry without any very noticeable reluctance.

Western Electric News

PUBLISHED MONTHLY FOR THE EMPLOYEES

BY THE WESTERN ELECTRIC COMPANY, INCORPORATED
 H. B. Thayer, *President* H. A. Halligan, *Vice-President*
 W. P. Sidley, *Vice-President and General Counsel* A. L. Salt, *Vice-President and Gen. Purchasing Agt.*
 Gerard Swope, *Vice-President and General Sales Manager* H. F. Albright, *Vice-President and Gen'l Superintendent*
 J. W. Johnston, *Treasurer* F. B. Jewett, *Chief Engineer*
 G. C. Pratt, *Secretary* R. H. Gregory, *Comptroller*
 C. E. Scribner, *Consulting Engineer*
 Office of publication and address of President, Secretary, and Treasurer, 195 Broadway, New York City.

BOARD OF EDITORS

P. L. Thomson, *Editor-in-Chief* S. W. Murkland
 P. K. Condict E. C. Estep
 W. F. Hendry F. J. Holdsworth H. D. Agnew
 John Colter Reed Calvin

Subscription: \$1.50 per year, except to employees of the Western Electric Company, to whom copies are furnished free of charge.

All communications and contributions should be addressed to WESTERN ELECTRIC NEWS, 195 BROADWAY, NEW YORK.

Matter intended for any given issue must reach New York not later than the 12th of the preceding month.

VOLUME VI APRIL, 1917 NUMBER 2

THE NEWS TAKES A CENSUS

"When a-pleasing of the public's to be done—to be done, The Editor's lot is not a happy one—happy one!"
 —Our Version of "The Policeman's Lot."

FOR many months the NEWS has been conducting elaborate inquiries to receive the opinions of its readers on the material that is appearing in its columns. The Board of Editors wanted to get first-hand opinion, frankly expressed, from the men and women for whom the magazine is published. The ballots sent out not only gave an opportunity to vote for the best liked of a number of representative articles of recent appearance, and to indicate a preference for this or that regular department, but allowed—indeed courted—criticism of the magazine. The results of this last feature were probably the most interesting of all, for they revealed a range of likes and dislikes on the part of Western Electric people, the suiting of which would try the diplomatic resources of a Talleyrand.

Brickbats and bouquets—they came in the same mail. The frankness of both kinds of criticism was refreshing.

"I like poetry, but some of the verse you publish is trash," writes a Canadian Western Electric man. But he adds "The NEWS is much looked for in our office and is intensely appreciated."

"The NEWS is the best industrial monthly magazine in print to-day!" writes one subtle flatterer with a

courtly sweep of the pen; while on the back of another ballot is bluntly scrawled, "Do not read it at all."

Some of the suggestions were cruel—positively cruel. "Invite humorous contributions—you'll get them"—was one demure hint. The NEWS has always somehow thought that a gleam of the funny in some way or other crept into its pages each month, but after this investigation the editors are not quite certain of anything.

"Why not put a few puzzles in the NEWS to be colored?" suggests one reader. "Put a question and answer column in!" was a bit of advice that came from many sources. "Run stories about prominent people" said others. "Why not some talks on different makes of automobiles" writes a motor-fiend from the West. And this—oh! crushing blow to our contributors!—"Why not insert in the NEWS each month a few of the thoughts of the world's best minds?"

On the whole, the questionnaires brought forth a great deal of useful suggestions and constructive criticism which will influence the makeup of the editorial menus of the future. The NEWS wants to interest, if possible, all of the people all of the time. It wants to bring closer together, year by year, the far-flung Western Electric organization.

That is why it took a census to see what you thought of its style of articles and its different departments. Here are some of the results:

Table Showing Comparative Number of Votes for Various Classes of NEWS Material:

CLASS OF MATERIAL	"As Now"	"More"	"Less"	"None"	"As Now" Pctge. to Total
Poetry	1,597	565	281	352	58%
Cartoons	1,418	1,043	145	83	53%
Photographs	1,347	1,252	60	36	50%
Humorous articles	1,465	770	71	37	62%
Untechnical talks on technical subjects	1,791	837	46	25	66%
Articles on engineering achievement	1,508	783	38	16	64%

It is of interest—and on the whole comforting and encouraging—to note that with almost three thousand votes cast on each of these questions, a clear majority is in favor of the NEWS as it is now.

The results of this inquiry of the readers' opinion of the NEWS has been interesting, but the Board of Editors hopes that the expression of opinion will not stop at this. When you have an idea for the NEWS, Mr. Western Electric man, for the sake of the magazine which is published for you as much as anybody, sit down and write a line to the editors. Give them ideas; give them criticism. Make it constructive if you can, but let us have it, even if you have no "better idea."

The NEWS looks for you for a more active share in its composition in the coming years.

Fourth Annual Report of the Employees' Benefit Fund Committee for the Year Ending December 31, 1916

MARCH 8, 1917.

To Employees of Western Electric Company, Inc.:

THE increase in the Company's activities during the year was reflected in the payments made from the Benefit Fund. The average number of employees increased from 15,298, in 1915, to 22,236, in 1916. A comparison of the payments made from our Fund this year and the last two years follows:

	1914	1915	1916
Pensions	\$ 37,620	\$ 44,258	\$ 40,326
Accident Disability Benefits...	22,676	13,907	23,435
Accident Disability Expenses...	7,226	5,121	7,344
Sickness Disability Benefits...	62,241	79,795	90,921
Death Benefits	24,610	88,111	23,318
	\$154,373	\$231,192	\$185,344

The pension roll carried eighty-six names at the close of the year—eleven employees were added to the pension roll during the year, and the following were removed from the roll by death: H. J. Colsey, William Patterson, John Stade, E. M. Barton, Emory Farrar, George Schmitt, William R. Patterson, William B. Culley, H. C. Scriba, J. J. Hayes, Rudolph Taborsky and S. E. Fritz.

It will be noticed that the amount of the death benefits is again approximately what it was in 1915, the abnormal amount in 1915 being due to the unfortunate *Eastland* disaster.

There were thirty-three deaths from sickness of employees having five or more years service.

Altogether, benefits were paid in 2,789 cases, or, in other words, benefits were paid to one out of every eight employees of the Company, or their beneficiaries.

As provided in the Plan, an audit of the Employees' Benefit Fund has been made for the year, and a copy of the certificate of audit is submitted herewith.

W. P. SIDLEY, R. H. GREGORY,
H. F. ALBRIGHT, J. W. JOHNSTON.
GERARD SWOPE,
Employees' Benefit Fund Committee.

Certificate of Audit, 195 Broadway New York

To the Employees' Benefit Fund Committee of Western Electric Company, Incorporated:

In accordance with the provisions of the Plan for Employees' Pensions, Disability Benefits and Death Benefits, as adopted by Western Electric Company effective January 1, 1913, amended May 1, 1914, and assumed by Western Electric Company, Incorporated, November 18, 1915, and pursuant to your instructions, I have audited the Employees' Benefit Fund as established and maintained by said Western Electric Company and its successor Western Electric Company, Incorporated, for the fiscal year ending December 31, 1916.

I find the Employees' Benefit Fund stood credited on the Company's books at the beginning of the year with \$1,000,000, that there has been added to the fund during the year by additional appropriation \$148,488.92, and by interest at 4% \$36,855.57, a total of \$185,344.49; that there has been expended during the year for Pensions, \$40,326.03; for Accident Disability Benefits, \$23,435.61; for Sickness Disability Benefits, \$90,921.01; for Death Benefits, \$23,318.00, and for Disability Expenses (including \$270.47 for State insurance), \$7,343.84, a total of \$185,344.49; and that the amount standing to the credit of the Employees' Benefit Fund on the books of the Company at the close of business December 31, 1916, was \$1,000,000.

I hereby certify that the receipts and disbursements, as above summarized, do in my judgment conform to the provisions of the Plan adopted, and that all the disbursements have been authorized by the proper Committee and receipted for by, or on behalf of the payees.

[Signed] D. C. RICHARDSON.

General Auditor for Western Electric Company, Inc.
March 15, 1917.

The Principal Points of the Benefit Fund Plan

IT may be well to call the attention of the employees, especially as we have so many new employees, to the principal points of the Benefit Fund Plan. Copies of the Plan can be procured by any employee upon application to the head of his department.

Should any of the employees have any questions, if they will send them either direct to the Secretary of the Benefit Fund Committee, or to the News, answers will be made to them either direct or through the medium of the News.

The principal points of the Benefit Fund Plan are:

1. *Pensions:*

Pensions are granted employees for age and length of service with the Company, and for disability. Pensions for age and length of service cover the following cases:

- (1) Where the employee is sixty years or more of age and has been with the Company twenty years or more;
- (2) Where the employee is between fifty-five and sixty years of age and has been with the Company twenty-five years or more; and
- (3) Where the employee is less than fifty-five years of age and has been with the Company thirty years or more. In all of these cases the age requirements of female employees, is five years less. Pensions for disability cover employees who have been fifteen years or more in the service and who have become totally disabled by reason of sickness.

The amount of the pension in any of the above cases is one per cent. of the employee's average yearly pay for ten years, multiplied by the number of years that he has worked for the Company. The minimum pension is \$20 a

month, except in cases of disability pensions where the employee has worked for the Company less than twenty years, or pension granted to employees who have only worked part time. Employment in any of the companies of the Bell Telephone System is counted in the term of employment.

2. Accident Disability Benefits:

These benefits cover accidents received in the Company's service. For total disability—that is, where the employee is unable to do any work—he receives full pay for thirteen weeks and half pay for the remainder of the disability. After he has received six years of benefit payments, the largest benefit is \$20 a week.

For partial disability, which is where the employee is able to perform some work, he receives for the first thirteen weeks the difference between the full pay and the wages which in the judgment of the Benefit Committee he is capable of earning, and after thirteen weeks, he receives one-half of the difference between his full pay and the amount which he is capable of earning. Payments of partial disability do not cover more than six years in all.

3. Sickness Disability Benefits:

All employees who have been with the Company two years or more receive certain benefits if unable to work by reason of sickness. These benefits begin eight days after the employee has been absent on account of sickness. For employees who have been with the Company ten years or more, the sickness benefits are thirteen weeks'

full pay and thirty-nine weeks' half pay; for employees who have been with the Company between five and ten years, the benefits are thirteen weeks' full pay and thirteen weeks' half pay, and for employees who have been with the Company between two and five years, the benefits are four weeks' full pay and nine weeks' half pay.

4. Death Benefits:

Where an employee dies from accident in the Company's service, those dependent upon him receive three years' pay, but not more than \$5,000 and burial expenses of not more than \$150.

Where an employee who has been with the Company ten years or more, dies from sickness or from accident outside of the Company's service, those dependent upon him receive one year's pay but not more than \$2,000. Where an employee who has been with the Company between five and ten years, dies from sickness or from accident outside of the Company's service, those dependent upon him receive six months' pay but not more than \$2,000.

Physical Examination:

In 1916, more adequate provision was made for the physical examination of all new employees, in order both to insure their good health when entering the Company's service, and also to safeguard those already in its employ against contagious disease among their fellow workers. The advantages of the physical examination and consultation with the company's doctor are also open to the older employees.



To Be Awarded in April

TWENTY-FIVE YEARS

Wagner, W., Hawthorne.....April —

TWENTY YEARS

Miller, E. M., Hawthorne.....April 21
 Filer, B. K., Hawthorne.....April 22
 Crane, G. H., Hawthorne.....April 27
 Menzies, Annie J., New York.....April 12

FIFTEEN YEARS

Pisar, J., Hawthorne.....April 2
 Church, L. D., Hawthorne.....April 5
 Hodaval, W., Hawthorne.....April 8
 Muzsikos, L., Hawthorne.....April 8
 Yochum, L. G., Hawthorne.....April 8
 Biederstadt, W. O., Hawthorne.....April 11
 Wittenberg, O. G., Hawthorne.....April 11
 Bohmeke, A., Hawthorne.....April 15
 Clerihan, S. A., Hawthorne.....April 16
 McLaughlin, J., Hawthorne.....April 16
 Wille, A., Hawthorne.....April 21
 Buckley, Margaret, Hawthorne.....April 26
 Hofmann, A., Hawthorne.....April 28
 Mann, G. W., Hawthorne.....April 28
 Weber, F., Hawthorne.....April 29

FIFTEEN YEARS

Dixon, A. F., New York.....April 29
 Ackerman, L. E., New York.....April 7
 Vollheim, O. F., New York.....April 10
 Raffo, P., New York.....April 19
 Davidson, Harold B., St. Louis.....April 9

TEN YEARS

Van Gorder, F. H., Chicago.....April 22
 Kimbrough, William T., Denver.....April 18
 Snelzer, C. T., Hawthorne.....April 2
 Zdamikewicz, J., Hawthorne.....April 2
 Rychlik, J., Hawthorne.....April 4
 Janota, B., Hawthorne.....April 6
 Cullieott, J., Hawthorne.....April 15
 Short, F. T., Hawthorne.....April 21
 Johnson, E. C., Hawthorne.....April 24
 Zastera, J., Hawthorne.....April 29
 Pickel, F. L., Hawthorne.....April 26
 Banta, Opal, Indianapolis.....April 27
 Shively, I. A., Kansas City.....April 22
 Doherty, K. B., New York.....April 1
 Mellor, Albert H., Pittsburgh.....April 1
 Montgomery, Robert J., Pittsburgh.....April 8
 Ryan, John F., Seattle.....April 22

William Wagner

William Wagner, assistant foreman of the tool-making department at Hawthorne, started work for the Company in New York 20 years ago. Most of his work in New York was tool-making, although for a time he served as assistant foreman of the plug and telephone instrument department. At the time of his transfer to Hawthorne he was foreman in charge of tool-making at New York. Besides being a good machinist Bill is—or at least used to be—a good church-goer. However, in his case “going to church” hasn’t always meant the same thing as “attending church.” In nice weather he used to have a little habit of “chauffing” the family to the doors of the tabernacle and abandoning them there, while he took the ‘bus out for a spin. After the benediction he would again appear and hurry them home for the Sunday dinner. And then one fine day he ran foul of another driver, also anxious to get somewhere. Somebody had to do something, and do it quickly. Bill was the goat. He clamped on his brakes and turned into the curb, with disastrous results. Verily the way of the transgressor is hard, but it is not quite so hard if he is an expert machinist and can repair his own damages. Of course, a lesson like that would have one of two results: Either the culprit would thereafter attend church when he “went to church,” or he would not go to church at all. Unfortunately, we can’t discover which way it worked in Bill’s case, so we can’t be sure that he is still a good church-goer. But we will guarantee that he is a good machinist.

G. H. Crane

Sub-set testing was the first work G. H. Crane did for the Company, back in '97. Since that time he has worked in the shipping department, store-room department, apparatus order department and repair department. His present position is with the piece-part tracing department. That, by the way, is no job for an ultra-pacifist—which George is not. Besides badgering foremen, his principal amusement is burning up gasoline and the boulevards in his sea-going automobile. George is also a bit of a bowler, a ball-player and an amateur photographer.

E. M. Miller



E. M. Miller

Every morning during the dusty season a cloud of dust whirls through the Hawthorne gates. It is E. M. Miller, head of the installation lay-out department. Behind him lies the speed limit, broken in sixteen sections. Ed. is nothing if not energetic. He started work at Clinton Street back in April of '97 in the factory cabling department. A short time later he went out with an installing gang under George Hopf, but returned to factory cabling after about four months on the road. He was soon made a “straw boss” in the cabling department, then assistant foreman, then foreman. During the six years that he had charge of the department it increased from about 10 employees to 200. In 1905 Mr. Miller was sent to Europe to install a factory cabling department in our London works and to introduce the Hawthorne cabling methods at Antwerp, Berlin and Paris. On his return he worked for a time in the output department and in the general foremen’s office and then took up his present work with the installation branch.

B. K. Filer



B. K. Filer

There was one time when B. K. Filer soldiered on the job, but since that was the only proper way to tackle that particular job perhaps it should not be held against him. It was during the Spanish-American War, when Burt was one of the “boys in blue” that the “popular” songster featured so vociferously in those days. Before his army experience he had been working for the Company as an installer (employed April, 1897), and on securing his discharge papers he again returned to the peaceful work of installing. In 1907 he was made an installation foreman and three years later became assistant superintendent of the western division installation. In 1913 he was appointed superintendent of the central and southern districts and in 1915 became eastern district superintendent. His latest promotion took effect December 1, 1916, when he became superintendent of installation.

One-Star Service Badge Holders



G. W. Mann



J. McLaughlin



A. A. Bohmeke



L. J. Yochum



O. F. Vollheim



L. E. Ackerman



L. Mussikos



Wm. Hodaval



O. G. Wittenberg



S. A. Clerihan



A. F. Dixon



I. D. Church

Men of the Hawthorne Clerical and Employment and Welfare Branches Enjoy Themselves

THE clerical branch and the employment and welfare branches held their annual banquet Saturday, March 3rd, at Hotel Sherman. Plenty of enthusiasm had been stored up in anticipation of the event, and it would be almost needless to say that "pep" was king that patriotic and gay evening.

C. W. Bergquist started things by offering a toast to the flag, to which all present responded by standing up and singing "America." Then followed a battle royal, in which the air was rent with forty-two centimeter balloons, bouncing and bursting in all directions. Charley nearly dislocated his disposition and a gavel in restoring quiet long enough to introduce the toastmaster and shift the responsibilities of the evening to E. M. Hicok.

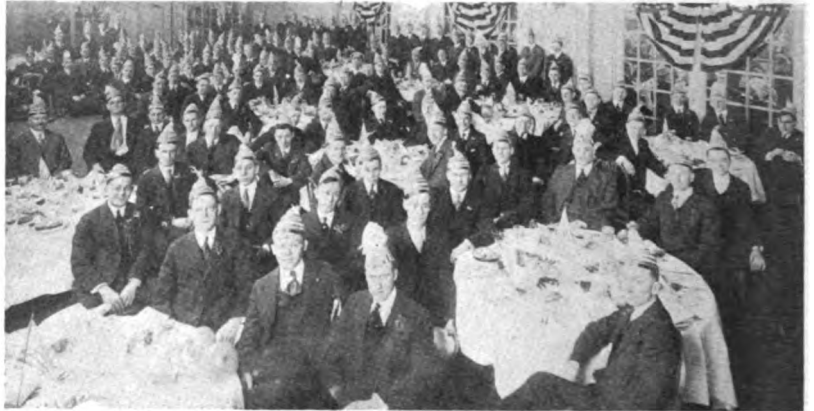

The Sad Ones Are Those Who Couldn't Go, so of course They Don't Show in the Picture

The program was lively, long and interesting with plenty of songs, started by the Misses Biddle and McCormick, cabaret artists, who rendered several catchy numbers. F. L. Zimmerman, of the foremen's clerks department, sang "Land of Hope and Glory." "Zim" is some singer, "which nobody can deny." Staveling and Schaffer offered a number of funny songs. Ray O'Hara, of the payroll department, tickled the keys, and everybody sang whenever there was a chance.

There were interesting remarks on the progress, service and efficiency of the branches by C. L. Johnson, H. F. Albright and J. W. Bancker; reminiscences and funny stories by C. C. Gilchrist, L. Montamat, S. L. Harding, H. D. Agnew, Doc Lucas and Geo. Starck.

After the speeches and story-telling all were presented with musical kazooos, which was the sign for further outbursts. While it is conceded that everybody did his very best, the god of harmony got a few jolts in the slats that evening.

The closing number on the program was a selection played by the payroll department's brass band, led by the famous band-master, Hair Rat (J. H. Rath). Their music was wonderful; you wouldn't believe it was in the instruments. And yet in spite of that the crowd hated to go home.

K. R.



The Pay Roll Department's Simp-funny Band at the Clerical and Welfare Banquet. TOP ROW—Left to right—Rockwood, Mudra, Herr Rath (Hair Rat) Bandmaster, O'Hara, Rezek. SEATED—Kahl, Goethe, Ullman, Snooks. FRONT ROW—Hennesey, Boland

HAWTHORNE ATHLETICS

Commercial League Baseball

THE Commercial League looks forward to another successful season. The League will probably be composed of the following clubs: Western Electric Co., Inc.; Illinois Tool Works, Thos. E. Wilson Co., Stewart Warner Speedometer Co., U. S. Ball Bearing Co., Nelson Morris Co.

The outlook was never more promising, and an abundance of good competition is expected. The present intentions are to open the season on Saturday, April 28th, so that the schedule may be finished in time for the winner to participate in the World's Amateur Championship Series.

The personnel of the team has been changed considerably, and a number of new faces will appear in the lineup when the umpire says "Play ball" in the first game. Harry Magers, who piloted the team for a number of years successfully, has resigned, much to the regret of players and fans alike. Too much credit cannot be bestowed on Harry for his work as manager of the Commercial League team. His record stands out as one any manager might be proud of. The destinies of the team this year will be guided by our old friend, Frank Naprstek, who has been with the team a number of years. "Nap" is one of the best known and best liked players in semi-professional ranks. His knowledge of the game and judgment of players is second to none. It is the opinion of

many that the team under the leadership of "Nap" will step out in front and stay there during the entire race, and our best wishes are tendered with the hope that the Western Electric team of 1917 will "bring home the bacon."

The new manager has surrounded himself with a strong aggregation of players. "Silk" Kavanaugh, Swanson, formerly with Columbus; Fox (Wichita, Western League, Chouinard, Madigan, Ginger and Shanley for the outfield; Fiene, Englehardt, Hora, Ginners, Evans, Anderson and Kessler for the infield; Tom McGuire, Cantwell, Reggy Richter, Williams, Whitehead and Cy Young as hurlers; Rehor and Reed for the back-stopping position. There is other material available and it is possible that some player not mentioned will be selected for one of the regular playing jobs.

Payroll Bowling League

The league, organized by members of the Payroll Department last fall, has been going along in great shape and much interest is displayed among the boys in that department. A spirit of good-natured rivalry exists and the leaders in the averages seem to derive considerable satisfaction in bragging of their accomplishments as real bowlers. A suspicion has arisen in some minds that these members are shooting the deadly "Dodo" ball. The boss has been appealed to, but to date he has not rendered a ruling. The case will be laid before the A. B. C. at the next convention.

STANDING OF THE TEAMS AT MARCH 10

	Won	Lost	Pct.
Checking and Figuring Section.....	27	18	600
Weekly Roll Section.....	26	19	578
Gang Piece Work Section.....	25	20	556
Service Section	19	23	452
Records Section	18	24	429
Adjustment Section	18	27	400
High Team Game—Weekly Roll Section (565).			
High Team Average 3 games—Service Section (526).			
High Individual Game—Heitzman (234).			
High Individual Average 3 games—Mudra (195).			
High Grand Average to Date—Palka (178).			

Hawthorne Golf Club Organized

At a meeting held March 10th, the Hawthorne Golf Club was formally organized, officers elected, and plans discussed for the coming season. The following are the officers for 1917: Harry Rautenbusch, president; Richard D. Jessup, vice-president; J. F. Grosvenor, treasurer; Chas. M. Dolan, secretary; F. A. Mueller, chairman of the sports and pastime committee.

The remarkable growth of golf in the Chicago district of the U. S. G. A., where it has replaced baseball as the national game, is reflected in the increase of golf enthusiasts at Hawthorne. In 1914 our players numbered thirty; in 1915 there were sixty-five; in 1916 this number had increased to 128, and this season it reaches 200.

Last year witnessed the first serious attempt to promote golf activities at Hawthorne. During the season eight tournaments were run off, and over fifty prizes were distributed to the winners.

In view of the interest shown, it was decided by the committee in charge that the time had come for the organization of a club to conduct the affairs of the golf players, and a meeting was accordingly called for this purpose. After the adoption of a constitution and by-laws, the officers mentioned above were elected.

The plan is to have a series of match and medal play tournaments on alternate Saturdays, beginning early in May and continuing until the first of November. All tournaments, with the exception of the Hawthorne championship for the Sidley Cup, will be run on a handicap basis, so everyone will have an equal chance to share in the prizes.

The club expects to start its initial year with a membership of at least one hundred. The dues have been fixed at \$2. This should provide plenty of prizes, and insure interesting competition at each tournament. The Harlem Golf Course, in the vicinity of Hawthorne, has been selected as the place for holding the tournaments.

Next month's NEWS will outline the season's program.

—E. A. Hemmer.



A Western Electric Man's Good Work on the Border

THE following letter, to Mr. Swope from Major William M. Hallahan, refers to Frederick Smith, of the local New York telephone sales department:

HEADQUARTERS, FIRST BATTALION, SIGNAL CORPS, N. G., N. Y.

Park Avenue and 34th Street
New York City

February 14, 1917.

Gerard Swope, Esq.,
General Manager, Western Electric Co.,
195 Broadway, New York City.

Dear Sir:

I wish to express my appreciation of the valuable assistance given me recently on the Mexican border by Mr. Frederick Smith, one of your employees.

Mr. Smith, a member of Co. "A," New York Signal Corps, was frequently in charge of telephone installation work, of a permanent and semi-permanent nature, as well as in several instances of emergency.

His work on these occasions was always of a high order, exceedingly well done and unfailingly efficient.

The cheerfulness with which he labored long hours and the splendid way in which he handled his men under trying circumstances was a subject for favorable comment.

Yours very truly,

[Signed] WM. L. HALLAHAN,
Major,

Chief Signal Officer, N. G., N. Y.



Frederick Smith

Challenge!

T. Elmer Moon challenges any member of the Hawthorne organization to a chess match by telegraph or letter. Mr. Moon's address is 2444 West Cumberland Street, Philadelphia, Pa. He is an employee of the Philadelphia organization. If Hawthorne members have the idea that they can play chess, here is an opportunity to prove their mettle.

Activities of the Hawthorne Club



"Have You a Little Fairy in Your Home?" Hawthorne Club Girls' Party, March 1st



First Prize Picture, Group 3, (*Home Portraits*), by K. A. Kjeldsen, Dept. 6965-A.

Now ye scribe felt considerably puzzled over just how to interpret that statement until the Camera Club gave its annual exhibit on February 15th. Then with those pictures as a contrast to his own, he knew. That comment on his pictures meant exactly what it said—hanging is

too good for them. But in spite of that they can just go hang anyway, while we talk about those *real* photographs at the exhibit. Or no; these pictures can talk for themselves, so we shall just let the first prize exhibits speak for the rest, while we list the prize winners. They are:

Group 1 (*Landscape and General Pictorial*)—1st F. W. Barta, 5059; 2d, Rose Smoller, 6346; 3rd, A. L. Estep, 6446; honorable mention, K. A. Kjeldsen, 6965-A.

Group 2 (*General*)—1st A. L. Estep, 6446; 2nd, E. H. Novak, 6066; 3rd, Marjorie Steel, 7498; honorable mention, J. H. Nicholson, 6107-A.



First Prize Picture in Group 6 (*Flashlight Photography*) by K. A. Kjeldsen, Dept. 6965-A

Group 3 (*Home Portraits*)—1st, K. A. Kjeldsen, 6965-A; 2nd, A. L. Estep, 6446; 3rd, H. Larson, 6965-M; honorable mention, E. H. Novak, 6966.

Group 4 (*Vacation Snapshots*)—1st, E. H. Novak, 6966; 2nd, Marjorie Steel, 7498; 3rd, Rudolph Safar, 6646; honorable mention, G. E. Olson, 6966.

Group 5 (*Babies Under Three Years of Age*)—1st, J. F. Wulff, 6968; 2nd, K. A. Kjeldsen, 6965-A; 3rd, F. W. Barta, 5059; honorable mention, J. M. Faust, 7486.

Group 6 (*Flashlight Photography*)—1st, K. A. Kjeldsen, 6965-A; 2nd, H. Larson, 6965-M.

Group 7 (*Collective Exhibit*)—1st, K. A. Kjeldsen, 6965-A; 2nd, F. W. Barta, 5059; 3rd, W. H. Meese, 6602; honorable mention, Marjorie Steel, 7498.

Group 8 (*Pictures Taken on an Official Trip of the Camera Section*)—1st, F. W. Barta, 5059; 2nd, A. L. Estep, 6446; 3rd, K. A. Kjeldsen, 6965-A.

The Club Girls Furnish an Illustration

After all, it is ludicrously easy to get a look at one of the "exclusive" parties of the Club girls—*after* you know how. The answer is: All womanity loves a photographer.

If you don't understand exactly how that answer applies, listen while the plot unfolds: Since none of our scribes had been able to get into these secret sessions of the sweeter sex, the harrassed editors finally decided to pass the buck to the staff photographer.

It worked. Oh, of course it worked! The girls couldn't resist the camera, so at last we are able to publish a little inside information. The picture is it. March 1st is the date of the achievement.

However, the scheme to get news to go with the photograph did not work out so well. The shorthand reporter who was smuggled in as the photographer's assistant has been drawing on the Benefit Fund ever since. Acute writer's cramp brought on by excessive overwork, the doctor says. Of course we ought to have realized what a cruel and inhuman thing it was to require one lone shorthand expert, unassisted, to take down the conversation of several hundred women. But we gleaned something from the poor fellow's incompleated notes besides how Mabel is going to make her blue voile and when Genevieve is to be married—and that is that the girls are already making



First Prize Picture in Group 2 (*General*) by A. L. Estep, Dept. 6446

plans for their summer camp. The place has not yet been selected, but the camp will be at some lake within about fifty miles of Chicago. Also it must be a lake where the water is near the shore. That was about the only drawback to the Long Lake cottage last summer—it was too far from the bathing beach. But, while the location is still to be selected, the fact that there is to be a summer cottage is now certain since the Company has generously offered to make up any financial deficiency incurred.



First Prize Picture in Group 1 (*Landscape and General Pictorial*) by F. W. Barta, Dept. 5059



First Prize Picture in Group 5 (*Babies Under Three Years of Age*) by J. F. Wulff, Dept. 6968

So, even though we didn't get all the details of the party, there is a choice bit of news for you, anyway. Then, besides, we *did* get a look-in on the party. Deuced clevah, too, we call that. Strategy, by Heck! Strategy—that's the stuff!



First Prize Picture in Group 4 (Vacation Snapshots) by E. H. Novak, Dept. 6966

Our Advertising Manager Talks on Advertising

With the shops working to an overtime schedule it is hard to get out to a 5:45 lecture. Consequently those who got over to the Restaurant Building February 15th for P. L. Thomson's talk on Advertising, considered themselves doubly lucky—once to get a chance to go to any lecture and twice because their chance and this lecture came at the same time. Mr. Thomson is a very interesting speaker, who not only knows advertising but knows how to tell about it. He had no trouble at all in proving that, while love may make the world go 'round, it's advertising that makes the wheels go 'round. Besides explaining many points of the publicity game, Mr. Thomson showed a moving picture of a magazine in the making, and another setting forth "The Education of Mrs. Drudge," a lady who begins with too much house-work but finally graduates into the class of electrical household appliance users and lives happily ever after.

Our Own Vaudeville

The Club's entertainment committee has perhaps been reading the parable about the man who hid his talents in the earth. Anyway, a short time ago they began



First Prize Picture in Group 8 (Pictures Taken on an Official Trip of the Camera Section) by F. W. Barta, Dept. 5059

digging around for enough home talent to make a complete vaudeville show. The result was the am—that is, the result was the performance given February 23rd. (If you refer to it as an amateur performance, you have to fight.)

At that, most of the performers were considerably above the usual amateur class, and all of them "got by" in good shape with the capacity audience that filled the second floor of the Restaurant Building. In fact, the satisfaction was so marked that there were many requests for another similar entertainment soon.

Now we don't for a minute intend to jeopardize our standing in the Hawthorne happy family by putting any "good," "better" and "best" labels on the various acts. Here is the program. Make your own selections:

PROGRAM

R. A. Corris, Director

R. D. Scott, Stage Manager

Overture.....W. E. Orchestra
 Popular Songs.....Al. Hempel, Dept. 6570
 Statuary Tableaux—(A) Bust Group, (B) The Critic, (C) Drowned,
 (D) Two Studies, (E) The Lesson, (F) The Confession, (G)
 Sisters, (H) Frightened. Originator, W. E. White, Dept. 6965,
 assisted by Misses L. Iwert and E. McGrath, Dept. 6965.
 "Those Three Fellows"—Wm. B. Sheean, Dept. 6142; J. E. O'Neill,
 Dept. 6115; R. A. Corris, Dept. 6372.
 Violin Solo.....J. McClure, Dept. 6372, assisted by G. Tesinsky
 Bass Solo.....H. E. Moser
 Something in Irish.....John A. Hulihan, Dept. 7147
 Cornet Solo.....Victor Hayward, Dept. 6431
 Whistling Solo.....Miss Fern Keeler, Dept. 7683
 Acrobatic Pantomime.....Leslie Sailor, Dept. 6622
 Melbourne Four—F. Peschek, Dept. 6619; O. Voleck, Dept. 6336;
 W. Hanke, Dept. 6619; A. Kretch, Dept. 6619.



Again Speaking of Installing Jobs

By J. J. Clifford

Being magnanimous by nature, we dislike to talk of the many original stunts pulled off around the Metropolitan (New York) District, but the stunt pulled by the 'stallers of the Southern District at West Palm Beach, Florida, as explained in the March issue of our "Monthly Heart Throb," did, to use a well-known term, "Get our Angora."

Far be it from us to rob our Southern brothers of their well-earned laurels, but in discussing the "All Aboard," "Going Up," "At Last" article, one general foreman was heard to remark that he kicked the slats out of his cradle laughing at his great grandfather explaining a humorous episode incident to the execution of the selfsame idea.

Now for an original, real live, novel, up-to-date stunt, what say you "Corn Crackers" to raising the roof of eleven sections of No. 10 board six inches and increasing the capacity of the board from 1,600 to 2,400 lines, and to cap the climax, without causing any interruption to service whatever.

Thank you, gentlemen, for your kind appreciation of our efforts. We point with pride to this job installed by that rising young installer, Mr. Samuel Unger, under the eagle eyes of Division Foreman W. J. (Pop) Swain and General Foreman H. Warneke.

Foreman—"Say, Bill! Are you keeping a record of those splices you're making?"

Gang Boss—"Naw! I don't need any record. I know where they are."
 —E. C. Watry, Los Angeles.

Western Electric News

Vol. VI. No. 3

May, 1917



Ready!

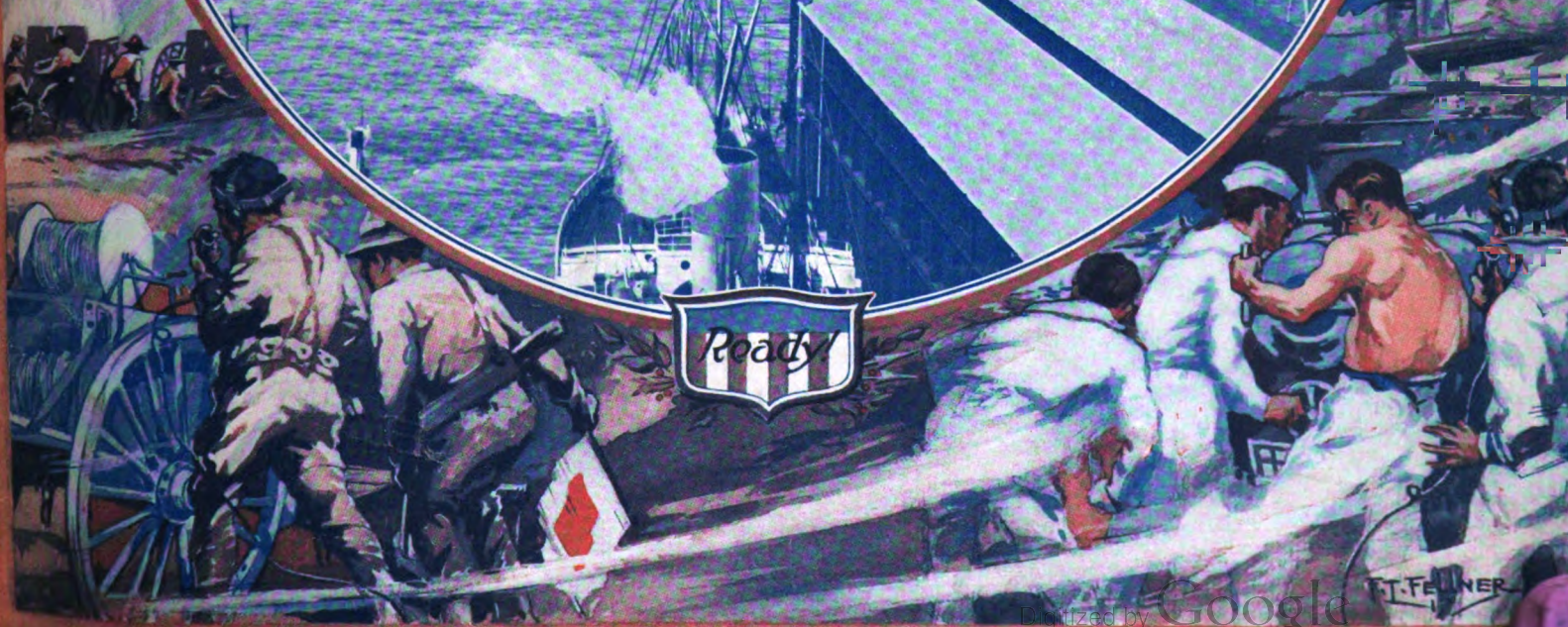

THIS MONTH'S COVER

WHAT you see in the photograph on this month's cover of the NEWS is a sight which Western Electric folks at 463 West Street thrilled to see in actuality in the early days of April when Destroyer 33 of our Navy moved quietly up the Hudson River, and with her starboard portholes winking at "463," dropped anchor directly opposite the great German merchant fleet moored on the Jersey side of the river. Uncle Sam was ready for any emergency. That was the day of the President's address. Sixty hours later, when war was declared, the entire German fleet, valued at nearly \$100,000,000, was taken over by the Customs and Military authorities.

Our photograph was taken by A. A. Chiani, the Engineering Department's photographer, from the top of 463 West Street.



VOLUME VI

NUMBER 3

Western Electric Men and the War

WE WESTERN ELECTRIC people think that we understand team work, and practise it, each man or woman with all of his or her intelligence and perseverance doing the thing that is given him or her to do, striving for the success of the team and getting reward in the success of the team, rather than striving for an individual record at the expense of the team.

The nation is at war. In preparation for war and in war it is necessary to maintain the great systems of national communication; *i.e.*, the telephone and telegraph, and in modern warfare the telephone is almost as necessary a part of the equipment of the Army and Navy as guns and ammunition. Therefore, it is the duty of the Company to keep itself in readiness to meet the demands which the communication service will require, and to furnish to the Military Departments of the Government the material for which we may be called upon for the Army and Navy.

Now is the time to apply the principle of team work to our citizenship. Team work means that we must all of us perform the duties which would bring the best result to the nation. For some of us duty lies in the industrial army, rather than in the military army. The Company intends to fully perform its duty to the nation, but to do so it is necessary that its employees should perform their duty when their duty lies in the direction of remaining at their usual work, rather than in going to the front. When it comes to a question of enlistment of one of the Company's employees, if enlistment means only an injury to the Company's business, we shall encourage enlistment, but if it means an injury to the nation's business, we shall point out what seems to us—with perhaps a broader view—to be the true line of duty.

A handwritten signature in dark ink, appearing to read 'W. H. Sawyer', is written in a cursive style. The signature is positioned above the word 'President.' which is printed in a serif font.

President.

The Western Electric Company in War Time

A Summary of How the Declaration of War Is Affecting the Company and the Employees

EVENTS move quickly in stirring times like these. Since the declaration of a state of war by Congress, each day has had its part in making history—not alone for our country, but for our Company and for the employees in it. Mr. Thayer's message, which accompanied the April News as a special insert, is followed this month by another which appears on the preceding page and outlines more fully the desirability of each of us considering very carefully the dual responsibility which faces us as citizens and as members of a great manufacturing organization.

In President Wilson's inspiring message of April 16th, he wrote these words:

"It is evident to every thinking man that our industries, on the farms, in the shipyards, in the mines, in the factories, must be made more prolific and more efficient than ever and that they must be more economically managed and better adapted to the particular requirements of our task than they have been, and what I want to say is that the men and the women who devote their thought and energy to these things will be serving the country and conducting the fight for peace and freedom just as truly and just as effectively as the men on the battlefield or in the trenches. The industrial forces of the country, men and women alike, will be a great national, a great international service army, a notable and honored host, engaged in the service of the nation and the world, the efficient friends and saviors of free man everywhere. Thousands, nay, hundreds of thousands of men otherwise liable to military service will of right and of necessity be excused from that service and assigned to the fundamental, sustaining work of the fields and factories and mines, and they will be as much part of the great patriotic forces of the nation as the men under fire."

At the time when these words are being written, Congress has as yet given no indication of the provisions it shall make for exempting from military duty certain classes of workers in the industrial army of the United States; but by the time this issue of the NEWS is being read by the employees this question may already have been settled.

In the plans of the National Defense Council continued emphasis has been given to the necessity for industrial preparedness, and an uninterrupted supply of those products necessary for safeguarding our land from invasion and for equipping our navy and our army with not only ammunition, but the other manifold necessities of warfare.

Early in the development of the national defense plans the American Telephone & Telegraph Company had the privilege of demonstrating to Government officials the marvelous degree of co-ordination of the means of com-

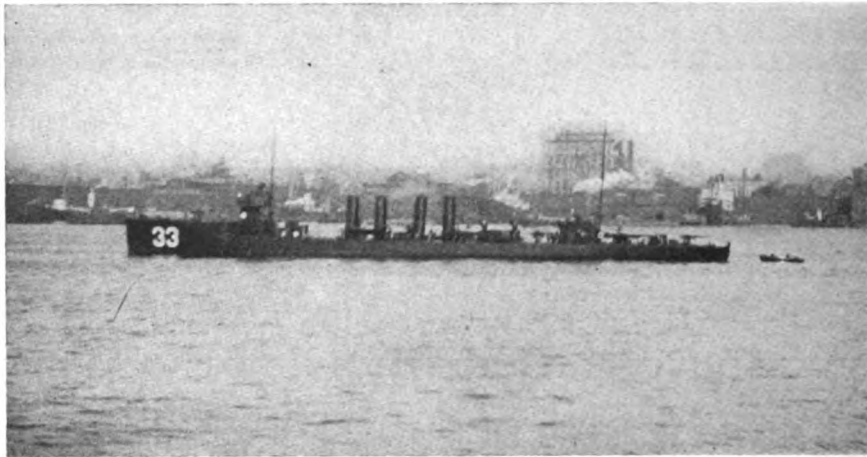

JUST BEFORE WAR WAS DECLARED

Destroyer 33 of the U. S. Navy, Lying Off the German Ships in the Hudson River—463 West Street in the Distance. This is Just the Reverse of the Front Cover Photograph, Having Been Taken from the New Jersey Side

munication which it had brought about through the perfection of the country's nerve system—the Bell Telephone, together with the wireless telephone.

The story of this remarkable achievement was told at the time in these columns, but who among us, as we read it, believed that within a few months that system would be put to the test, that we of the Western Electric

Company, as one of the arms of the service, would be having our attention drawn to the necessity of our helping to maintain intact the manufacturing and engineering organization forming an essential unit in this great system?

The Company has already been called upon to furnish to the Government, telephone and other equipment intended for the use of both the army and the navy. The services of our engineers have been requisitioned by the Government for the purpose of studying some of the engineering problems with which both branches of the service are confronted. And so it is that both in our shops and in our laboratories Western Electric artisans and engineers are "doing their bit."

Announcement was made last month of the appointment of Frank B. Jewett, Chief Engineer, as Major in the Signal Officers Reserve Corps of the United States Army. Mr. Jewett has also been appointed a member of the Physics Committee of the National Research Council. The duties of these two positions have made it necessary for Mr. Jewett to spend much of the past month at Washington. Vice-President A. L. Salt has been named as a member of the Emergency Committee of the American Red Cross, of which Mr. Newcomb Carlton, President of the Western Union Company, is the Chairman. Mr. Salt is also serving on the New York Advisory Committee on the Purchase of Army Supplies. This committee was appointed by the Chamber of Commerce of the United States at the suggestion of the Council of National Defense to assist the quartermaster's department of the army in the purchase of supplies. The problem of securing supplies for an army being organized on so much larger a scale than ever before has been a difficult one for those in charge of this branch of military work, and this committee of five men of large experience in business and the purchasing of equipment, serving without any compensation, is proving of valuable assistance to the Government.

Along with some other corporations the assistance of the Western Electric Company has been sought by one of the states in tabulating the returns from the military census which has been authorized. Thus are the utensils of industry and peace being utilized for one of the preliminary steps in preparation for war. It is a far cry from trench-digging to operating tabulating machines, but both are essential to real preparedness.

In line with the suggestion made by President Thayer last month, there has been very little enlisting of the Company's employees in the army or naval militia for active service. On later pages in this issue are recorded, so far as the information has come to the NEWS, the names of employees who at the outbreak of the war were already enrolled in the National Guard, Naval Militia and the various reserves, to whom the call to arms has come. Many thousands of our employees, recognizing the desirability of some familiarity with military training, have joined the Home Guards or Home Defense Leagues throughout the country, and, in addition, others are studying military tactics through the medium of the college men's training corps and various other voluntary courses of instruction.



OUR FLOODLAMPS AID IN HOME DEFENCE WORK
The Home Defence League of Bayonne, N. J., Drilling at Night by the Light of the Western Electric Floodlamps

The American Telephone & Telegraph Company has given to the United States what is perhaps the finest auxiliary signal corps possessed by any army in the world. About 500 engineers have been selected for this work, and many of these have already been sworn into the Government service. The work of these men is to plan, set up and operate telephone, telegraph and wireless plants and to assist the regular Government corps of men engaged in wireless operation. Other associated telephone companies have organized signal reserve corps among their employees. The disposition among employees of the operating telephone companies has been in this way to retain their positions with a view to enabling the operating companies to provide the country with organized units of trained telephone men when and if they become necessary.

Western Electric people from one end of the country to the other have heard the President's call for a food supply preparedness which begins in each man's own garden. To the already considerable number of tillers of the soil among our 30,000 employees will be added this year many thousand more. One Western Electric official in the East is in charge of an extensive project to turn the acres of waste land on his golf course to the profitable production of vegetables. No doubt there are other interesting developments of this food problem, to the solution of which other Western Electric men are giving their attention.

In general, it may be said that the war has found us as an organization and as individuals ready to meet our responsibilities in the best way as soon as we know what that way is.

Chicago Man Gunboat Commander

The first man of the Chicago organization to enter the United States service following the Declaration of War with Germany was David C. Guest, of the Clinton Street Sales Department.

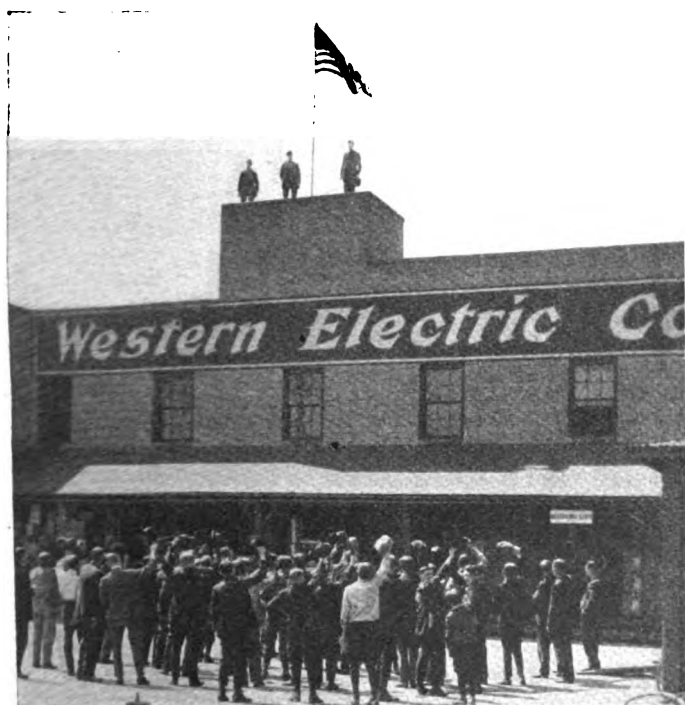

In the Early Days of April, When the War Excitement Ran High, the Denver Western Electric People Had a Flag-Raising. Gordon S. Wardell, Sergeant in the National Guard, Made the Address to His Fellow Workers

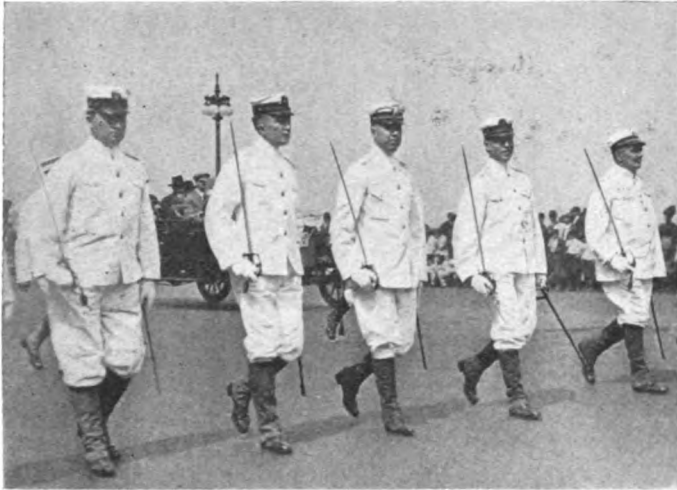

At the Extreme Left—Lieutenant-Commander David C. Guest

Mr. Guest is Lieutenant Commander in the Illinois Naval Militia and left Chicago on April 10th for Detroit to take command of the United States gunboat Wolverine stationed there.

Lieutenant Commander Guest is a regular sea-dog with nineteen years' experience to his credit in the Naval Militia. He first entered the service in 1898 at the outbreak of the Spanish-American War. He saw service that year upon the United States converted gunboat Maple, and was awarded a medal by the Government for participation in a naval battle off Havana.

He has cruised every year since with the navy. Last year he spent his vacation aboard the battleship Alabama.

So far as the News can learn, Mr. Guest has the highest rank of any Western Electric man in active service.



Western Electric Man in Charge of Novel Defence Plan

M. A. Curran Helps Turn Dunwoodie Golf Course Into Truck Garden to Grow Crops

EVERY ONE has read in the papers about the great national necessity for an increase in foodstuffs during the coming year because of the war. General Credit Manager M. A. Curran, who is a member of the Dunwoodie Country Club of Yonkers, N. Y., helped initiate, and is now in charge of a patriotic movement on the part of his golf-playing *confreres* to devote part of their leisure time and muscular effort to a wielding of the hoe instead of a vicious swiping of the niblick. Already from all parts of the country the novel idea has been caught up and put into execution by golf country clubs. The famous Brae Burn Club of Boston has decided to put 75 acres under cultivation.

"Something is being planted in every available part of the Dunwoodie course," said Mr. Curran, as the NEWS went to press. "Our plans call for two acres of sweet corn, two acres of potatoes and four of garden truck. The land has long since been plowed and harrowed, and perhaps the most striking part of the affair is that hundreds of members of the club who have already fallen in with this scheme themselves are the laborers who are going to do the work.

"The problem in food production in this country is not a problem of land, seed or climate, but labor. Thousands of men who have done nothing much in their leisure hours but play golf, are going to put in time each week in raising crops."

An interesting feature will be the fine of 25 cents which



DUNWOODIE'S HOE BATTALION

One Squad of the Golf Club Members Who Began the Links-to-Garden Movement.
The Eighth Man from the Right End Is M. A. Curran

will be exacted from each member who drives a ball into the garden stuff. The plans of the club have been enthusiastically endorsed by the United States Golf Association, the parent of all the golf clubs of the country.

As crops mature, they will be sold to the club, its members, and to outside consumers if there is a surplus—at prevailing market prices. It is the present intention of the golf gardeners to buy a motor ambulance with the proceeds or give the money to any project recommended by the Government.

Western Electric Men So Far Called To The Colors

From Hawthorne

Name	Military Organization
Urbanski, S., Dept. 6031.....	1st Ill. Infantry
McMahon, A. E., Dept. 6162.....	1st Ill. Infantry
Slater, R. C., Dept. 6107.....	1st Ill. Infantry
McDermed, John F., Dept. 6300.....	1st Ill. Infantry
O'Kane, Francis R., Dept. 6300.....	1st Ill. Infantry
Zalkus, John J., Dept. 6321.....	1st Ill. Infantry
Spitizior, Philip, Dept. 6322.....	1st Ill. Infantry
Vanderwerker, Milton, Dept. 6336.....	1st Ill. Infantry
Coston, Franklin W., Dept. 6339.....	1st Ill. Infantry
Pallin, G. C., Dept. 6374.....	1st Ill. Infantry
Werner, Fred, Dept. 5376.....	1st Ill. Infantry
Moravek, Edward, Dept. 6378.....	1st Ill. Infantry
Matuga, S., Dept. 7381.....	1st Ill. Infantry
Carlson, A. W., Dept. 6442.....	1st Ill. Infantry
Gourley, George B., Dept. 6601.....	1st Ill. Infantry
Pletka, Charles, Dept. 6615.....	1st Ill. Infantry
Mix, G. H., Dept. 6618.....	1st Ill. Infantry
Eddy, J. M., Jr., Dept. 6622.....	1st Ill. Infantry
Vanek, Otto, Dept. 6623.....	1st Ill. Infantry
Vana, Jerry, Dept. 6631.....	1st Ill. Infantry
Callahan, Frank J., Dept. 6641.....	1st Ill. Infantry
Solhem, A., Dept. 6645.....	1st Ill. Infantry
Hoff, George J., Dept. 6338.....	2nd Ill. Infantry
Bruno, A. R. J., Dept. 5376.....	6th Ill. Infantry
Mangan, G. W., Dept. 6965.....	6th Ill. Infantry
Powell, J. E., Dept. 5376.....	6th Ill. Infantry
Pallak, Steven P. L., Dept. 6965.....	Ill. Engineer Corps
Sullivan, Bernard M., Dept. 6372.....	1st Ill. Field Artillery
Kosatka, F. V., Dept. 6030.....	Ill. Naval Reserve
Sale, S. W., Dept. 6036.....	Ill. Naval Reserve
Lucker, Walter A., Dept. 6321.....	Ill. Naval Reserve
Stample, J., Dept. 6321.....	Ill. Naval Reserve
Edgren, Harry C., Dept. 6324.....	Ill. Naval Reserve
Consier, Edward John, Dept. 6334.....	Ill. Naval Reserve
Drysch, Raymond J., Dept. 6334.....	Ill. Naval Reserve
Hernlund, J. W., Dept. 6422.....	Ill. Naval Reserve
Forrest, Walter S., Dept. 6435.....	Ill. Naval Reserve
Unger, M. S., Dept. 6435.....	Ill. Naval Reserve
Ewart, J. B., Dept. 6603.....	Ill. Naval Reserve
Boehme, W. R., Dept. 6460.....	Ill. Naval Reserve
Kenney, George P., Dept. 6460.....	Ill. Naval Reserve
Knoff, Sigfried V., Dept. 7487.....	Ill. Naval Reserve
McGarry, James J., Dept. 7489.....	Ill. Naval Reserve
Brems, Chas. H., Dept. 6570.....	Ill. Naval Reserve
Lancaster, Ralph J., Dept. 6570.....	Ill. Naval Reserve
Bugner, C. E., Dept. 6603.....	Ill. Naval Reserve
Becker, Edwin B., Dept. 6615.....	Ill. Naval Reserve
Haderly, Frank Henry, Dept. 6615.....	Ill. Naval Reserve
Leach, Clarence E., Dept. 6615.....	Ill. Naval Reserve
Schulte, Harry G., Dept. 6619.....	Ill. Naval Reserve
Woellel, Harold L., Dept. 6623.....	Ill. Naval Reserve
Anderson, Thos. B., Dept. 6640.....	Ill. Naval Reserve
Henderson, Harold F., Dept. 6640.....	Ill. Naval Reserve
Lucker, Harry E., Dept. 5660.....	Ill. Naval Reserve
Lambe, Harry, Dept. 6671.....	Ill. Naval Reserve
Rice, A. C., Dept. 7683.....	Ill. Naval Reserve
Nottke, William A., Dept. 7697.....	Ill. Naval Reserve
Gibbons, Wm. J., Dept. 5909.....	Ill. Naval Reserve
Weins, William L., Dept. 6965.....	Ill. Naval Reserve
Kruse, Herbert John, Dept. 6967.....	Ill. Naval Reserve
Voelker, Walter Richard, Dept. 6967.....	Ill. Naval Reserve
Hall, Arthur G., Dept. 7985.....	Ill. Naval Reserve
Southwick, W. A., Dept. 7985.....	Ill. Naval Reserve
Childs, Harold D., Dept. 5905.....	U. S. Navy Reserve

Name	Military Organization
Kendall, Richard C., Dept. 6515.....	1st Mo. Infantry
Geeting, John G., Dept. 6113.....	2nd Montana Infantry
Bills, E. J., Dept. 6505.....	2nd Mass. Infantry
Gallagher, C. V., Dept. 6510.....	Ohio Naval Reserve
Brooks, M. C., Dept. 6505.....	Pa. National Guard
Bradfield, E. C., Dept. 6505.....	Pa. National Guard
Kennedy, J. D., Dept. 6505.....	Pa. National Guard
Spoerl, W. P., Jr., Dept. 6505.....	Pa. National Guard
Kiefer, Carl E., Dept. 6113.....	3rd Wis. Infantry

Recapitulation

	On duty	Subject to call
Members of National Guard Units, Illinois.....	62	200
Members of National Guard Units, other than Illinois.....	10	60
Members of U. S. Reserve.....	1	18
Total.....	73	278

From Installation Department

PITTSBURGH, PA.

Caldwell, W. E.—1st Pennsylvania Field Artillery, N. G.
 Allen, E. E.—4th Regiment Motor Boat Squad, Delaware, N. G.
 Sturgeon, W. H.—1st Pennsylvania Field Artillery, N. G.
 Harvey, G. M.—Company "G," United Boys' Brigade of America.
 On reserve list of Co. "A," 18th Infantry, U. S. N. G. of Pa.

NEW HAVEN, CONN.

Bills, E. J.—Company "E," 2nd Regiment, Massachusetts Voluntary Militia.

BALTIMORE, MD.

Uhler, A. G.—Company "G," 1st Va. Alexandria Light Infantry, U. S. N. G.

From Philadelphia

Edward Gilbert Baker.....National Guard
 Edward Smyth.....National Guard
 George Crawford Thompson.....National Guard

From Dallas

C. K. Lawson.....Infantry, National Guard
 A. B. Clayton.....Infantry, National Guard
 C. L. Ambruster.....Naval Militia
 J. F. Wilson.....Naval Militia

From Engineering Department, New York

H. R. Lake.....National Guard
 A. F. Hooper.....National Guard
 F. E. Unbekant.....National Guard
 E. W. Boise.....National Guard
 R. A. McGuigan.....National Guard
 J. B. Egan.....National Guard
 E. C. Joho.....National Guard
 G. F. Landgraf.....National Guard
 C. G. Samuels.....National Guard
 E. K. Dickinson.....National Guard
 A. S. Bown.....National Guard
 J. G. Veit.....National Guard
 H. A. Reybert.....National Guard
 A. G. Webster.....National Guard
 A. W. Lawrence.....National Guard

From the General Sales Department, New York

H. C. Boley—Troop A, 1st N. Y. Cavalry.
 J. A. Kick—Capt., U. S. Signal Corps Reserve,
 Clarence O'Neil—1st Battalion N. Y. Naval Militia.

Things Hawthorne Makes, and How Heat Coils

By E. C. Pierce, Department 6437



Fig. 1—Soldering the Coil Wire to the Pin and Sleeve Assembly

OF the many different types of apparatus manufactured at Hawthorne, one of the smallest is the heat coil—so small, indeed, that you could hold several hundred of them in your two hands. A heat coil is a special kind of fuse designed to protect telephone apparatus from currents too small to “blow” the regular line fuses, but strong enough to injure the apparatus if they flow for a considerable time. One of these midget coils is no bigger around than a lead pencil and barely $\frac{3}{4}$ of an inch long, yet six parts enter into its construction and fifteen operations are necessary in order to assemble these parts.

The first step in the assembly of this apparatus is the soldering of the “sleeve” to the “pin.” The “pin” is simply a tiny metal rod with screw threads on one end and the “sleeve” is a short bit of copper tubing with a notch cut in one side of it, making it look like a tiny whistle. The operator slips the tube over the rod and places them in a special rack which holds twenty-five. Then holding a gas flame under the parts to heat them, she picks up a tiny disc of solder with a sharp-pointed tool, touches the solder to the notch in the copper tube, and presto, the job is done.

The next operator places these assembled parts in a fixture quite similar to the one in which the previous operation was performed, and solders to each little copper tube one end of a piece of fine wire about a foot long.

The next job is to wind the wire around the copper tube to form the coil. This is done by placing one end of the “pin” in the winding machine, which, when the operator presses the foot pedal revolves at high speed. Just the right length of wire must be left hanging loose after the coil is wound, the turns of the coil must be close together,

and the coil kept from unraveling by tying a loop in the wire around the coil. It requires quite a bit of practice and a pair of sharp eyes to wind these little coils.

The largest part of the heat coil is the shell, made of a cylindrical cup of red hard rubber, as big around as a pencil and about half an inch long. First, a fine slot is cut in one side of this shell with a miniature circular saw. It is then ready to have the code number branded on it. The code stamp is held in a little machine consisting of a dial with a number of pegs sticking up out of it, and an electric iron which keeps the stamp hot. The operator slips the shells onto the pegs of the dial, which revolves. As one peg at a time moves into the proper position, the hot code stamp moves up against the shell and leaves its impression. The shells are automatically removed from the pegs after branding and slide down a chute into a receptacle under the bench.

Then the shells are taken to a foot press, where a metal washer is assembled to the closed end. This washer is of the same diameter as the shell, and has a slot in one side which must “line up” with the slot in the shell.

Next, the coil (wound around the “pin” and “sleeve,” as described above) is assembled into the shell. The operator clamps the “pin” in one side of the assembly fixture shown in Fig. 3, slips the shell into the other side, pushes the two

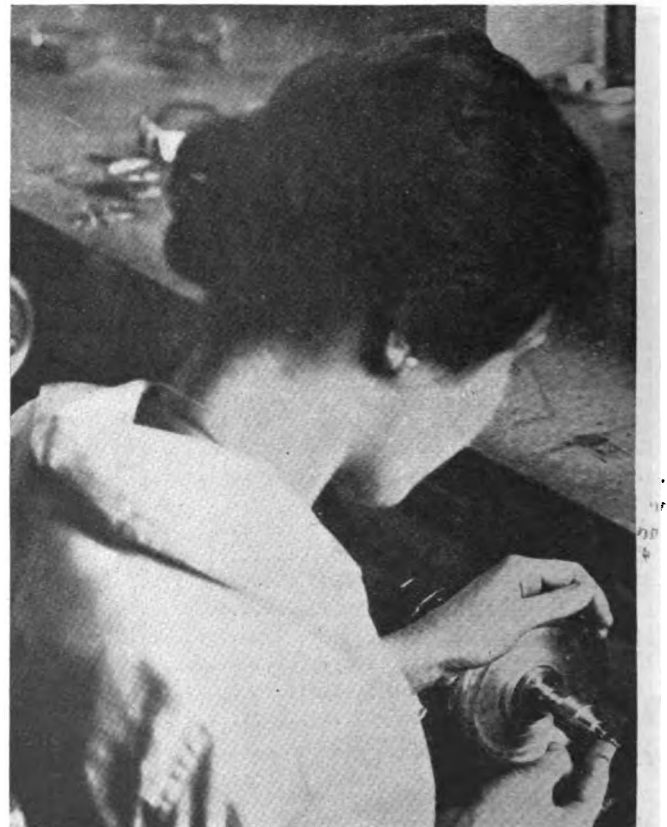
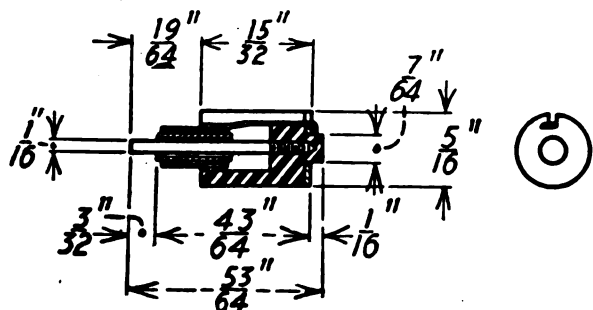

Fig. 2—Winding the Coil

together and by rolling her hand over the knob on the end of the shaft, screws the shell onto the threaded end of the rod. It must go on just so far and no farther. Only



Dimensions of the 61-A

one-sixtieth of an inch variation is allowed, so it is necessary for the operator to gauge each assembly. If she has not turned the shell on far enough, or has turned it too far, she can remedy the defect by reclamping the rod and turning the coil with her fingers.

The next operator brings the unsoldered end of the coil wire out through the slot in the shell. Another operator skins the insulation from the loose end of wire and cuts it off to the proper length, and still another operator solders this end to the metal washer, which is fastened to the closed end of the cup-shaped cylindrical shell, as already explained. The final operation of cutting off the projecting end of the little rod to the proper length is performed in a special fixture attached to a bench motor driving a suitable cutter, and the apparatus is completed.

The requirements which this little coil must meet are many. Of course, all the dimensions must come within the limits set by the designer. Beside this the electrical resistance of the coil must be above a certain minimum and below a certain maximum. A force of six pounds applied to the end of the copper tubing must not move it



Fig. 3—Assembling the Coil in the Shell

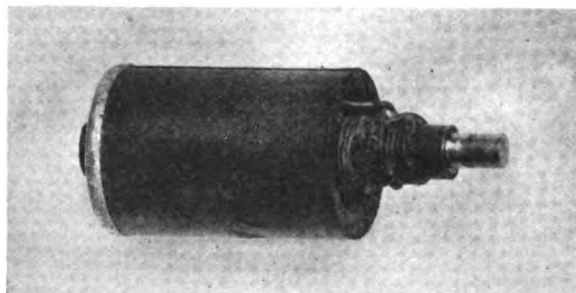

The 61-A Coil Finished

along the rod. The coil must carry a certain electrical current for three hours without operating and must operate within 210 seconds when a certain other specified current is applied.

Heat coils are connected in the telephone line at the point where the line enters the central station. An excessive current in the line passing through the coil will generate sufficient heat to melt the solder holding the little copper tube in place on the pin. This allows the tube to be pushed along the pin by the action of a spring, the movement of the latter connecting the line to the ground. Although this temporarily puts the line out of business, the escape of the abnormal current protects the central station apparatus from injury, and after the cause of the trouble is removed, the "blown" heat coil is replaced by a new one.

Results of New Customers and New Business Contest for February, 1917

THE salesman securing the largest number of new customers during February was:
F. O. Lightfoot, Chicago.

The salesmen securing the highest number of points or sales to new customers during the month of January were:

- J. E. Lowrey, Dallas, 154 points.
- A. B. Spicer, St. Louis, 135 points.
- A. B. Vandercook, Los Angeles, 125 points.

Our New Branch Store



T. L. Holmes

A branch store of the New York distributing house has been opened at West Haven, Conn. A complete stock of electrical supplies is now carried, in addition to the stock of telephone supplies heretofore carried at that point for the Southern New England Telephone Company. The address is 135 Wood Street.

T. L. Holmes is manager.

Swinging Around That Circuit

Random Notes of a Traveler to the Distributing Houses

Part I—The Branch House Conferences

A POPULAR cartoonist says "They all look good when they're far away." Funny, isn't it, how the other fellow's job always seems to be easier or more interesting than the one which Fate or your boss has picked out as the particular job for you to do?

Doubtless most of us who work at desks or at machines are accustomed to think of the traveling salesman's lot as pretty much of a snap. The work out in the open air, the freedom to come and go, the constantly changing scene that meets his eyes—"Pretty soft," we say.

Well, as a matter of fact, it isn't. That's only just one side of the story, and the same thing is true of every job in the company.

Speaking of traveling, I suppose there are a lot of people who look upon any job that necessitates traveling as more like a vacation than work. The circus poster cartoons, which find their way into the News after the visits of general department people at a series of sales conferences at the houses, perhaps contribute to such a conclusion; in view of which some other aspects of these conferences may not be without interest.

Almost anything becomes a task when it becomes necessary. And in a business as complicated as ours, a considerable amount of visiting is necessary between the members of the general sales department at New York and our distributing houses.

The time chosen for these visits is ordinarily the first month or two of the year. That is the period when there is apt to be a lull in the buying of electrical supplies, and when therefore the salesmen can best afford to leave their territory for a week or more and report at their headquarters for what has generally become the annual sales conference of the house.

These meetings are arranged to follow one another in a definite schedule so that it may be possible for the four or five general department men to visit most of the houses, give their messages to the salesmen at each house, get the benefit of the men's experiences in the field, and then hurry along to the next stopping place.

"Hurry" is the word, too, most of the time; because covering the Western Electric offices east of the Rocky Mountains involves a trip of at least 7,000 miles, and, as



Making a Close Connection at a Junction Point

there are fourteen distributing houses in this portion of the country, outside of nine branch offices and stores, stretching from Boston on the East, to Dallas on the Southeast and Minneapolis on the Northwest—well, you can see that there is "some" territory to cover.

"Life on a Pullman" would be a fit title for this story. Frequently it happens that the New Yorkers spend three out of seven nights a week on trains, although ordinarily there are two nights' sleep to be had at a hotel between rides en route.

The conference sessions convene at nine in the morning, two in the afternoon, and at eight in the evening. There is no time left for play until the last night when the house is accustomed to hold its annual dinner. At these affairs the visitors are the logical victims for the practical joker of the distributing house—the fellow who has to "put on" the banquet. In spite of the fact that they have been talking "shop" three times a day for two or three hours at a stretch, their powers of endurance are assumed to be without limit, their sense of humor eternally keen; and, after a heavy dinner, they are called upon for a few choice remarks. Each is expected to tell a clever story or two, felicitate the house upon its enviable record, its able management, the high order of intelligence in its office force, the unlimited "pep" of the salesmen, and the rare beauty of the young women employees, easily outranking that of any similar group at any other house.

The Banquet Program

This program is sometimes varied, as at Dallas this year and at Cincinnati last year, by the introduction of various and sundry pranks upon the distinguished guests. Imagine, for instance, the versatile Bert Hawkins being called upon for an address to the young people of the organization, and after once getting a fair start, being interrupted by an exploding bomb directly behind him, indicating that his time was up. Loud and long was the merriment which followed this clever *coup*. And good old Bert smiled on just as though he himself had planned the interruption.

Merry quips and jests of this nature planned by the house people as a part of their near-holiday come to mean

little in the lives of the New Yorkers to whom the holiday aspects of branch house banquets are apt to wear off after they have indulged in three or four of them within ten days.

The cabaret performers have by this time arrived at our banquet, but we shall have to interrupt the jollification for a few minutes as it is time for the visitors to take their train. Farewells all around, good wishes to the boys for increased sales and profits this year, and then the five of us try to get together in the lobby. Tommy has his troubles getting his stereopticon and lantern slides packed and checked; the fussy Walter Washington Square Templin discovers that his laundry hasn't been returned, and the famous pink shirt is among those missing; while the taxicab man that "Traffic Manager" Bill Schnedler has engaged to transport us to the station flatly refuses to carry Charley King's wardrobe trunk.

King's Holy Trunk

That trunk, by the way, had an erratic career. Brand new when we started out on January 4th, it was already carrying a fatal bruise when it reached Richmond, the first stop. It had the appearance of having fallen upon the point of an upright crowbar. This, so, Walter informed Charley, was the mark of identification placed upon it by the baggage man who first handled it and whom Charley had neglected to tip. Templin ought to have it straight, because he once was a station agent. At all events King found a new hole in his trunk at every stop on the tour. Thus fully ventilated, he now uses it as a cage in which he keeps some of the queer specialties he has brought out in recent years.

Reference has been made to our "Traffic Manager." Bill was accorded this post of honor because back in the '90's he was business manager for a middle western road show, "*The Clover Leaf Girls*," playing one night towns from Keokuk, Iowa, to Mesquite, Texas. In this capacity he handled the transportation—that is when they took in enough at the door to leave a surplus for railroad tickets.

In our case Bill had it easy, for we turned over to him most of the money we drew when we started and he bought all of the tickets. Bill was some buyer of tickets, too, seldom failing to secure the customary five lowers. When there were only four and an upper, why "Temp" took the upper. The boy didn't see it that way at first. He wanted to match for it, and all that sort of thing. Finally, Father King settled it.

"Walter," said he, "just remember that this is your first trip in this distinguished company. Just remember that you're the junior member of this party. You take that upper and say no more. If you don't we'll never bring you along again." So Walter accepted the verdict. After that we had no trouble with him; he seemed to understand his place.

The Hunt for Hawkins

But to return to our taxicab which in the intervening time has been ticking away the company's dimes. The luggage all in place alongside the driver—that is all but King's holy trunk which will follow, and Tommy's motion picture machine which because of its fragile nature our own Elmendorf insists upon holding on his lap. On account of it Walter insists that the Advertising Manager should pay two taxicab fares, but he is over-ruled.

It is after eleven o'clock and the train starts at eleven-thirty. "What's the delay, Bill?"—this to the patient "Schned." standing in the cold outside the cab.

"Bert's not here—I've got to go in and hunt him up."

"Oh, the devil—let's go on without him"—this from King—"maybe he'd be on time if we'd just leave him behind once. Remember I gotta' check my trunk yet."

At this juncture Schned. appears.

"Bert's lost his hat. He left it in the check room with his coat but the boy can't find it. Bert's inside there now, trying on every hat in the place."

A parley ensues, the frost on the window of that taxicab in the meantime melting, but before it can be determined how to split up the party into two taxis, the late Mr. Hawkins bobs up as serene as ever, deposits himself "somewhere inside" and the caravan proceeds to the depot.

It is close to midnight before the curtains are drawn in front of Lower 8 to 12. The car is an old one and it squeaks in every joint as it rolls along over a road bed of uncertain tendencies. It is the dilettante Walter whose voice is heard lifted above the noise. He is occupying Lower 12 directly over the wheels.

"Porter," says Walter, and there is just a suggestion of weariness in his voice—"Porter, can't you stop that rattle?"

6.30 A. M.

Our train is due to arrive at 6:30 in the morning but the time-table generously informs us we may occupy our berths until 7. Four of us manage to complete a hasty toilet inside of the time limit, and along with the switching engine by this time coupled to our car, we await the arrival of Bert Hawkins. He comes finally after a couple of toots by the engine, and accompanied by the porter who bears his collar and tie in one hand and various other articles of apparel together with grips in the other.

The dressing is concluded in the taxicab en route to our hotel where we congratulate ourselves we can immediately repair to the rooms that the local manager has reserved for us. A shave, a cold shower, and a change of clothing will go a long ways to compensate us for the short and somewhat doubtful night's rest, and key us up to a zippy start-off for the opening session of the conference in less than a couple of hours.

"Reservations for Western Electric" repeats the sallow-faced clerk as we register. "Yes, we have them, but they're for this evening. We were full up last night, and I'll have to ask you to wait until some of the guests check out."

No, dear reader of the NEWS, when they tell you that beating it around over this broad United States, and selling yourself and your lines to several hundred salesmen, is just one grand and glorious junket; you can discount it about 50, two 10s and a 5.

[Next month, Part II.—*Sidelights on the Boys in the Real West.*]

Changes in Organization

J. B. Shay has been appointed Stores Manager at Boston, succeeding A. W. Hughes, who has been transferred to the General Distributing Department at New York.

W. H. Graham will succeed Mr. Shay as Chief Stores Manager, reporting to C. H. Minor.

The Development of Manufacturing Equipment

By W. F. Hosford, Engineer of Mechanical Methods at Hawthorne

IT is the constant aim of the Manufacturing Department to keep the machine equipment employed for all classes of work at least *equal* in efficiency to the most improved types of equipment that can be purchased on the market. This policy is, of course, necessary in the interests of economy if the Manufacturing Department is to maintain its high standards of quality and at the same time meet the exacting requirements of the many intricate designs of apparatus which our engineers develop.

Only four justifications for providing new types of manufacturing equipment are recognized:

When old machinery wears out, obviously it is necessary to replace it, and in such cases the most improved designs are, of course, selected.

Another demand for new machinery arises when the Engineering Department submits new types of apparatus, whose designs or requirements are such that they can be more successfully met by employing machinery of special design.

A third justification for installing new equipment is when it will result in raising the quality of the product.

The fourth reason for providing new equipment is to reduce manufacturing costs. Equipment of this class is ordered only when it is possible to prove it in on a dollars-and-cents basis by the savings which will result.

No definite rule as to the return on the investment is followed in proving in new equipment. Each particular case is considered separately on its own merits. If the machinery is to be employed for a class of operations which may be rendered unnecessary by changes in the design of the product, then the practice is to order it only when the contemplated savings will cover the total cost of the installation in a relatively short period of time. This is usually from one to two years.

The rapid advance in the art of telephony with the attendant changes in the design of the apparatus results in a severe economic handicap in the production of the apparatus. Until the designs become more stable minimum costs cannot be expected.

The equipment is proved in on a somewhat longer basis in cases where it is to be used for a class of operations so standard in manufacturing work that changes in the design of the product will not eliminate the necessity for performing them. Seldom, however, is machinery installed strictly for cost reduction purposes if the savings during four years of operation will not cover the total cost of the installation. Manufacturing methods are

changing and developing so rapidly that it is not conservative to assume that any standard class of operations will remain unchanged for a much longer period than this.

New equipment is bought on the market whenever standard products fulfill all of our requirements or when appreciable improvement upon stock machinery is considered impractical. However, in many cases we are not satisfied that the standard equipment available on the market is the best that can be devised for the purpose. In other cases the requirements of the job are so unusual that no standard equipment can be found to handle the work satisfactorily. In these cases it is the practice to design and build the equipment at Hawthorne.

Developing New Equipment

The most important consideration in developing new equipment is the quality of the work it will perform. A very careful preliminary study is made of the requirements of the product.

When new equipment is considered for cost reduction purposes, the first step is to make a thorough study and analysis of the methods employed with the old equipment, including the cost of performing the work. By dividing the operations into their elements and by making studies and tests to determine the limiting factors of each element, the operations can be reconstructed along different lines until a certain combination is devised which is more efficient than any of the others.

During the preliminary study period it is, of course, necessary in most cases to carry on more or less extensive tests and experiments.

Preliminary studies of this nature have been made recently on many types of equipment, such, for instance, as that required for enameling tinned copper wire, for varnishing paper and muslin, for impregnating jumper wire with Sarco, for tinning copper wire, etc.

During this preliminary study, the analysis of the operation frequently suggests means of performing it which are not commonly employed. As the results which may be obtained are not definitely known in such cases, it is the practice to construct experimental models to try out the principles under consideration, and in some cases to construct complete experimental machines for preliminary tests.

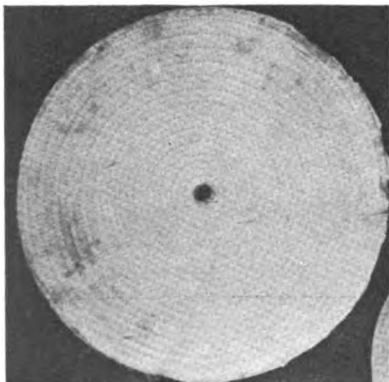
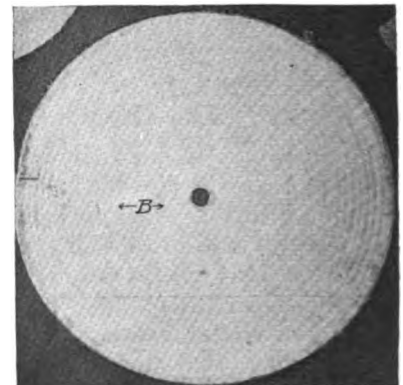

Fig 1—Buffing Wheels

The Unsewed Center of the Wheel at the Right Is Used for Nickel Buffing after the Outside Section Has Been Worn Away on the Heavy Work



The design of the new buffing and polishing equipment at Hawthorne furnishes a typical case and one in which the various steps are easily followed.

As the reader probably knows, buffing and polishing operations are required upon many of the parts we manufacture. Take, for instance, a transmitter bell. The punch press operations leave the surface quite rough. To prepare the part for plating, this roughness must be removed by a polishing operation, followed by buffing. It is perhaps needless to explain that in both polishing and buffing the work is held against wheels that revolve at high speed and smooth off the surface of any article held in contact with them. Polishing is done with a leather or canvas wheel having a fine abrasive glued to its surface. Buffing wheels are made up of muslin discs sewed together. (Fig. 1.) Different abrasives are rubbed on these muslin wheels, according to the work to be done. Buffing is divided into two operations, known as "cutting down" and "coloring."

Buffing and polishing wheels are ordinarily attached to machines that are nothing more than horizontal shafts driven by overhead belts and equipped with hoods for catching the dust that flies from the wheels. (See Fig. 5.)

The Things To Be Gained

Some time ago it was decided to undertake the development of new equipment for this work. Several conditions prompted this decision. Those of you who have seen polishing and buffing operations as they are ordinarily performed, no doubt have a distinct recollection of the dirt and lint thrown from the wheel against the operator and scattered through the air by the many flying belts. You also probably recall that the maze of belts in the room cut off the light and made the department a gloomy looking place. The polishing and buffing department at Hawthorne was not much better in these respects than the general run of such shops, since it used the standard buffing machinery.

But when a change in the location of the buffing and polishing department was made necessary by the expansion of the plant, it was felt that when the department was moved changes ought to be made which would improve the working conditions for the operators.

Furthermore, it seemed almost certain that the common practice of driving buffing spindles at a constant speed regardless of the diameter of the buff must necessarily be inefficient, since under these conditions the speed of the rubbing surface at the circumference of the wheels constantly grows less and less as the wheels wear away.

No very comprehensive data could be located showing the importance of definite speeds for polishing work. We, therefore, installed an experimental direct-driven polishing motor with a controlling apparatus for securing a wide range of speed.

With this equipment a series of tests was carried on, in which various classes of work were buffed at different speeds. As a result of these tests we learned that the maintenance of a constant surface speed throughout the life of the buff considerably increased the outputs over those obtained by the practice commonly followed. We also learned that the most efficient speed for buffing varies with the shape of the part and the material from which it is made and that even the maximum speed obtained with

the belt-driven installation was considerably below the most efficient speed for the bulk of our work.

Tests of this nature on a large number of different classes of parts brought out the fact that buffing the parts at the proper speed and maintaining this speed throughout the life of the buff would produce an output about 20 per cent. greater than that obtained with the single-speed equipment we were employing. The savings which would result were sufficient to prove in the installation of direct-driven variable speed machines.

The variable speed motor which we used in our tests

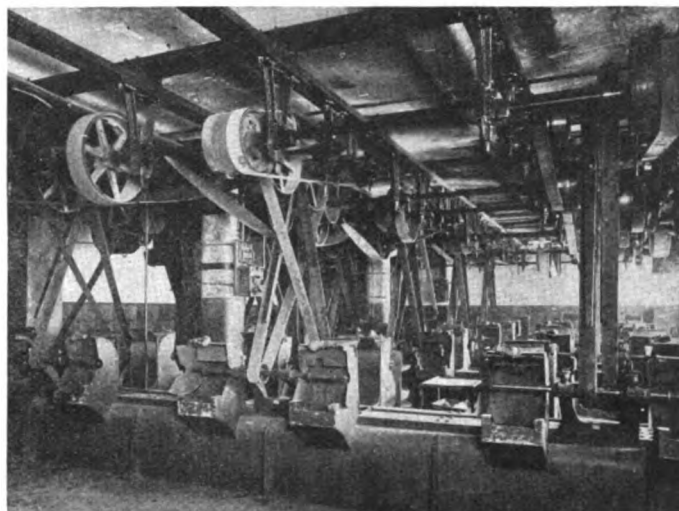

Fig. 5—The Usual Type of Equipment Employed for Polishing and Buffing

was a direct-current machine. As the principal generating equipment at Hawthorne is alternating current, a question immediately arose as to the possibility of obtaining approximately the conditions desired by employing alternating current machines.

We, therefore, rigged up a 4-speed alternating current machine, two of the speeds being obtained by a special frequency from a motor generator installation. These four speeds were distributed over the desired range. From the tests conducted, data was compiled showing the relative efficiency of the different installations.

Buffing transmitter bells with the single speed, belt-driven installation, we found that with a new 14" buff only eighty-five parts could be buffed in a given time against 100 with the variable speed direct current equipment. The number dropped to a little above fifty when the buff had reduced in diameter to 9".

The 4-speed A. C. installation had only two speeds which fell within the range of highest efficiency on this particular part. Consequently we found a large decrease in the output as the buffs wore, although the results were, of course, better than those obtained with the single-speed machines.

Curves were compiled for 4-speed A. C. installations of various speed combinations, but in all cases the results showed that the efficiency of the direct current installation was enough greater than that of the 4-speed A. C. installation to justify its adoption.

After this decision was reached a number of features of design remained to be worked out.

In designing the new machines, we wished to arrange

for the most economical size of buff, all things considered, and a study was therefore made, to determine the size of buff which would cover our requirements for the various classes of work at the lowest cost.

The Size of the Buffs

The greater part of our work requires a sewed buff and our previous practice was to buy this buff in the 14" diameter. Larger buffs are desirable because they decrease the amount of time spent in changing buffs and also because the percentage of waste buff is less, since the unused center is the same size regardless of what the outside diameter of the wheel was at the beginning.

A 14" buff not only costs more than a 20" buff per unit area, but in addition our practice of wearing them down to a 9" diameter on heavy work and then using the 9" buffs for light work produced more buffs of 9" diameter than were needed.

The method by which we eliminated the excess was this: For nickel buffing we use an *unsewed* buff 9" in diameter, which we previously bought in this size. We now dispose of all our surplus 9" centers and at the same time fill our entire requirements for this nickel buff by having part of our 20" buffs made with the "B" zone unsewed. (See Fig. 1.) In this manner when the buff is worn down to about the last row of stitches it is made into a 9" loose buff by cutting down its diameter enough to remove the stitched portion.

The buffing machine which was designed to meet the various requirements outlined is shown in Fig. 2.

Some of the details of the motor designs were unusual. As the speeds we desired were considerably above those ordinarily employed in buffing, a study was made to decide upon the type of bearings most suitable for the installation. As a result of this study, we decided upon ball-bearings. Since this was non-standard construction, it was necessary to build the end bells with the bearings at Hawthorne, and ship them to the manufacturer for assembly. They constructed only the armature and frame, all the rest of the machine being built at Hawthorne. Since the high speed at which these machines are operated

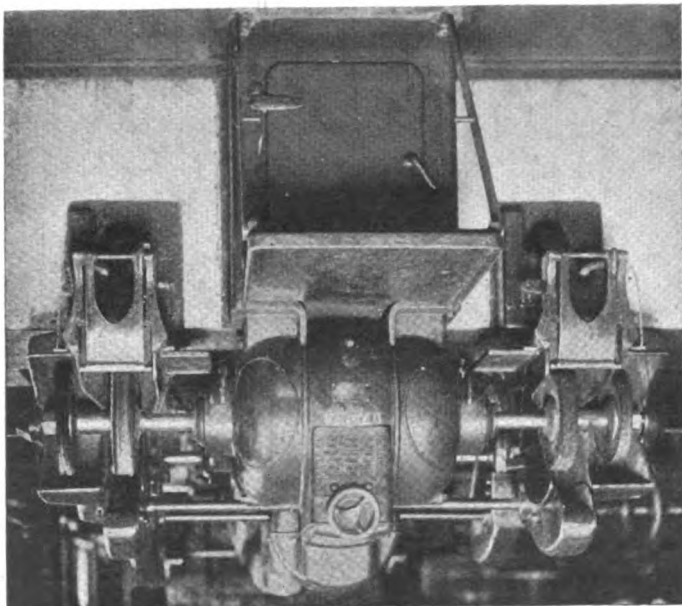

Fig. 2—Variable Speed Buffing Motor Developed at Hawthorne

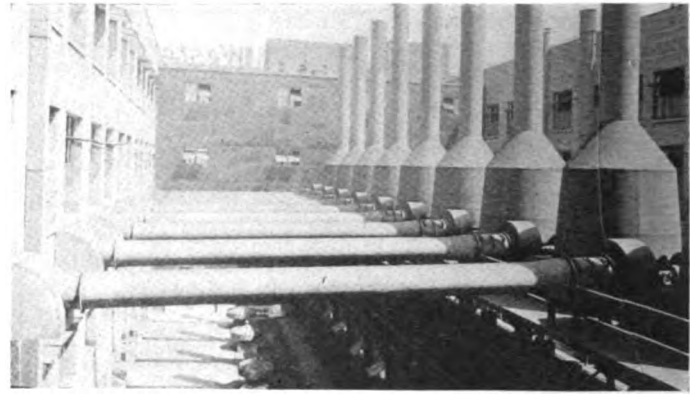

Fig. 3—Cyclones Which Catch the Dust Sucked from the Buffing Machines

puts an unusual strain upon the spindle, we made the shafts from chrome vanadium steel.

The machine is started and stopped by means of the two push buttons shown just under the hand wheel in the center of the motor. They are connected with contactors in the pedestal of the machine, which throw the current on and off. The front of the pedestal has a door as shown to enable repairs to be easily made.

The hand wheel is directly connected with the shaft of the field rheostat mounted in the housing on the back of the motor. The speed chart immediately below the hand wheel shows the proper setting of the rheostat to obtain any desired surface speed for any diameter of wheel. The layout for the part specifies the surface speed which is most efficient for the work. The piece-work prices are based on running at the speeds specified, and as the maximum outputs are obtainable at these speeds, it is, of course, to the operator's interest to follow the instructions on the layout.

In buffing and polishing work a great deal of lint, dirt and buffing compound is thrown off the top of the wheel. It is very difficult to catch this in the hood below, owing to the angle at which it leaves the wheel. The hoods on these machines are so designed that air is exhausted at the front of the hood above the wheel as well as below it. This is accomplished by means of an air duct, which extends up the back of the hood. In this manner we are able to catch most of the dirt which ordinarily flies off the top of the wheel.

The machines are exhausted through a round pipe located inside of the long bench between the machines, which also acts as a table for work. The exhaust fans, motors and dust collectors are located outside of the building.

Fig. 3 shows the new installation of cyclones which exhausts these machines.

The motors driving the fans are located under the cylindrical housings on the pipes just before they enter the cyclones. The fans exhaust into the cyclones, which discharge up into the air.

As the mounting of such cyclones on the outside walls of the building would have greatly obstructed the lighting in the sections a special structure was provided for carrying the equipment. As those familiar with Hawthorne know, there is a long passageway leading south from 22nd Street between two of the long wings of the Telephone Apparatus Shops. The cyclone installation is mounted on



Fig. 4—Buffing Department at Hawthorne Equipped with the New Variable Speed Buffing Motors

the top of this passageway. The space between the buildings at this place, due to the railroad tracks and driveway located between them, is much wider than the standard courts, and this made it possible to install these large cyclones midway between the buildings without affecting adversely the light in the buildings on either side.

In connection with the development work on the ma-

chines, it was necessary, of course, to decide upon the size of machine required for various classes of work and the number of machines of each size which would be required for a normal output. This was done by installing on the experimental direct-driven machine an ammeter which recorded graphically the amount of current used while the operator was buffing. From ammeter charts, the decisions were arrived at. Heavy machines, 10 h.p. and $7\frac{1}{2}$ h.p. were designed with hoods for 20" buffs and smaller ones, 5 h.p. and $2\frac{1}{2}$ h.p. with hoods for 14" wheels.

Getting Piece-Work Rates from the Machines

An interesting fact is that after the machines were installed many of the piece-work rates were set by employing this same recording ammeter, which indicated the actual length of time required to perform the work, since the current, of course, increases while the part is bearing on the buff. This is the only case that I know of where piece-work rates have been set from data automatically recorded by the operator.

There are 54 of the new type machines in the present installation (Fig. No. 4). In order to handle the same volume of work with the old-style equipment, about 65 machines would have been needed. The advantages which were derived in better light and improved working conditions are clearly apparent.

Hawthorne Plant Department Holds a Banquet

A KNOCKER in last month's News remarks:
"Banquet pictures!

"As Bunker Bean said: 'I can imagine nothing of less consequence.' Oh, ye editors, an' you seek suggestions, let us have no more views of twenty to two hundred sad-faced humans seated about a 'festive board.' Let us rather imagine them as we would have them—joyous and well-fed."

Now it is difficu't to look cheerful when you have to stop

to get your picture taken right in the very midst of such a food feed as was set before the plant department cohorts at their banquet, but they don't look so very mournful at that. Anyway, everybody was happy, especially after getting outside of the meal. Talks were given by O. C. Spurling, G. A. Pennock, H. G. Dean, C. B. Barnes and J. J. Cogan.



AMONG THE ENGINEERS



Hawthorne

W. E. Viol, Correspondent

ZERO IN RECOMMENDATIONS

We don't know why New York picks on Hawthorne, when they live in such a big glass house themselves. We quote from a recent letter from New York:

"We are sending you herewith, 2 copies of memorandum No. 234, covering our recommendations on relay replacements in connection with the Toll Switchboard No. 1."

And here is memorandum No. 234:

"Present Relay—1—44-C Relay. Replaced by——. Note: No recommendations at present."

Hawthorne would like to nominate the above as the "Infinitesimal of Recommendations."

The Tuesday Night Bowling League, composed of twelve five-man teams, has closed a very successful season. The prize winners in the league race were as follows:

Team 4—M. J. Raab, Capt. Won 23—Lost 10.

Team 1—C. L. Osgood, Capt. Won 22—Lost 11.

Team 10—C. Holm, Capt. Won 21—Lost 12.

Team 4 was also awarded the silver loving cup as "Bowling Champions" of the Engineering Department. Their pin average for the season was 702.

In the Tuesday Night Handicap Tournament, twenty-two prizes were awarded. H. Nelson and A. C. Walkington carried away the gold and silver watch fobs with total scores of 575 and 569, respectively. The individual high game prizes were won by F. J. Nadherney, M. J. Raab and E. Kral, with totals of 226, 213 and 206, respectively.

The Monday Night Bowling League is still playing on its regular schedule, which ends April 30, 1917.

New York

K. Bungerz, Correspondent

We were going to say a lot of screamingly funny things about the pass system. As it happened, H. H. Gamble, of the New York Distributing House, needed the idea, so we handed it over to him, along with the loan of our best cartoonist.

Speaking of the New York House reminds us of the fact that they had a banquet. Among those who rendered assistance, solos, etc., were Clarence Cole (Engineering Department), aeroplane builder; G. B. Hamm (Engineering Department), actor-playwright; not to mention F. X. Loeffler (Engineering Department) who drew the sketches of the affair.

In the account of the banquet we ran across the following *adjectives*—originality, pep, humor, dash, etc., etc. Wow!!

PATIENCE!

We wish, we do, that when an H. C. L. article is fitted out with our mitt holding a lot of miniature grocery pack-

ages that "Bill" Riecken made for his youngster's Christmas, the NEWS would credit the Engineering Department with something. That photo was turned down four months ago and now it bobs up again.

The department is moving some more at the expense of one R. Gordon and his associates. Departmental locations are like that organization chart—always being reconsidered. The 1,000-ton press in the basement must feel sadly neglected. It has stood in one spot for about three years.

The organization chart has really been sprung at last. Mr. Jewett showed it to us the night he talked on departmental organization.

P. R. Goodwin (gosh, how that man breaks into print) has promised an article on "The Clerical Branch" for the June NEWS. Don't say we didn't warn you.

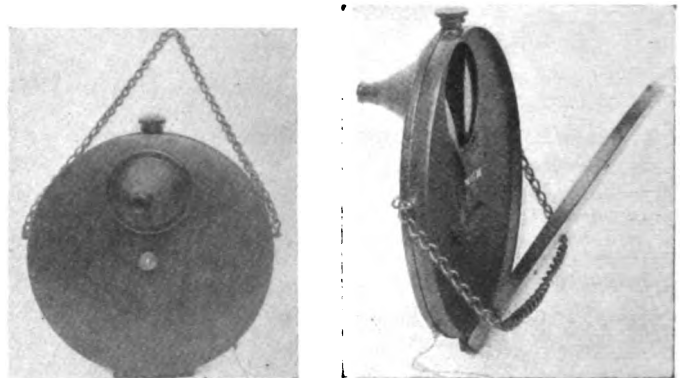

We reproduce here a picture of a "dielectric camera made by Western Electric Company, New York, and patented by R. D. Gray, July 27, 1886, at New York." These interesting views have been lent to the Historical Museum by A. A. Ciani, of the Engineering Department, who owns the camera. It was purchased by his brother back in the '80s.

The camera is so devised as to be easily carried under the coat—the lens projecting through a button-hole. It was operated by pulling a spring which released the sector shutter, which made one-quarter turn—actuated by a tension spring wound from the front. Its lens had an approximate diameter of $\frac{1}{4}$ inch. It took a $2\frac{1}{4}$ -inch circular picture—four pictures on one plate—employing for this purpose a $6\frac{1}{2}$ -inch circular plate. The diameter of the camera was $6\frac{3}{4}$ inches; $2\frac{3}{4}$ inches thick over all. Originally the camera was nickel-plated, but the sample was in later years given a black finish. It sold for \$25.00.

As we go to press (for want of a regular exordium), we learn that the physical laboratory is hiring "lady engineers." Yes, woman, here as abroad, is usurping man's

Who Can This Poor Creature Be??

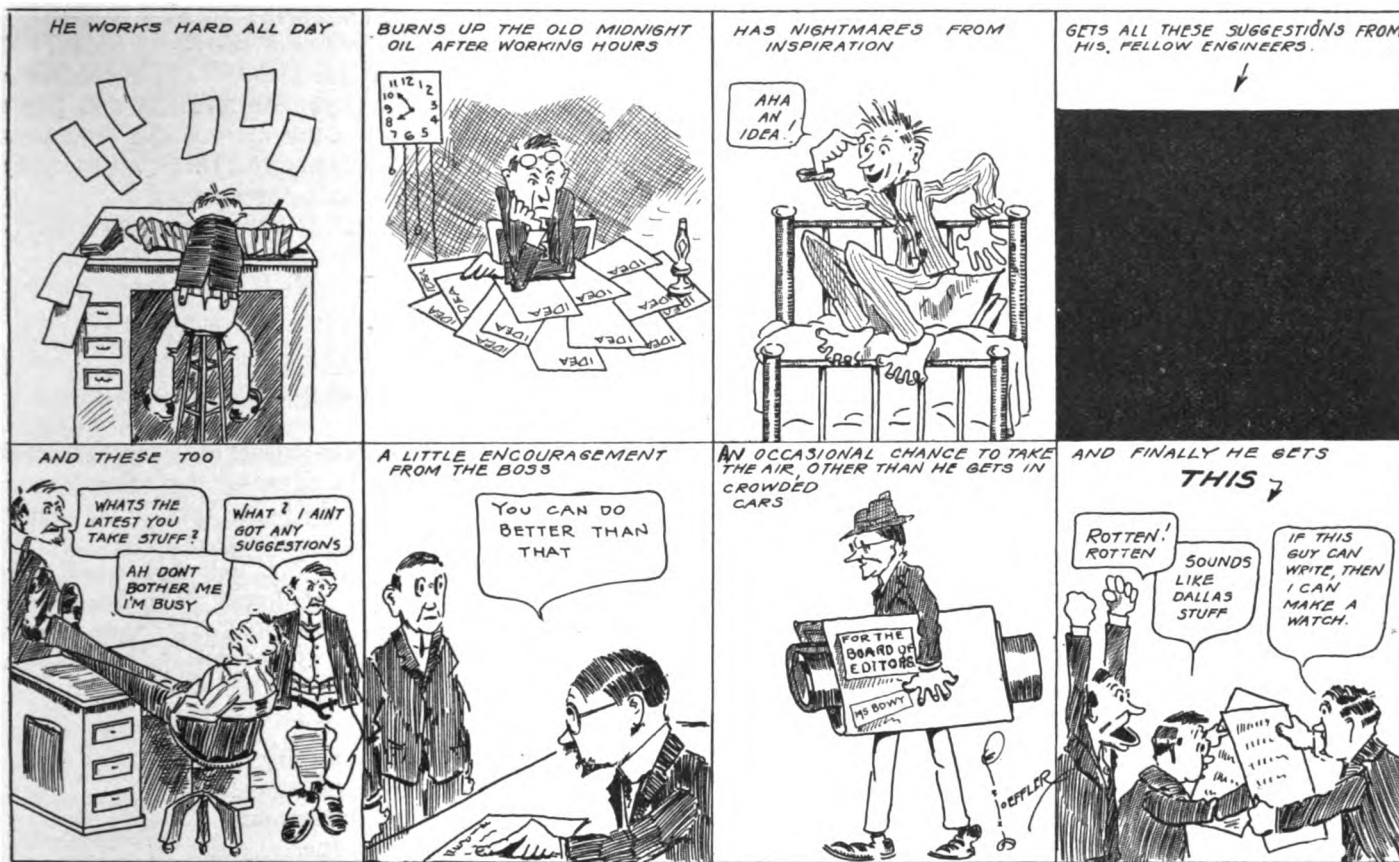

The Great Guessing Contest for Engineers

place. She has begun to take her place in our own organization. What are we bid for the interviewing privilege?

Judging from change order 50,467-B, the shop has passed the buck to the Engineering Department in the

matter of standardizing pencil points. Here's the requirement as set down by D. A. Wallace's crowd:

"The rivets in top of shelf may be visible after finishing, but there shall not be any cavity large enough to catch the point of a pencil."

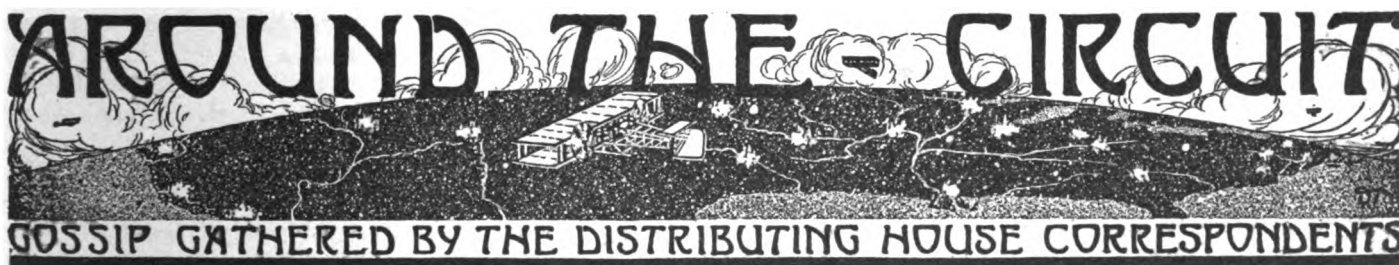

Atlanta

O. Whitmire, Correspondent

Our new Manager decided there was too much love-making going on in our office, so he built a little office in our warehouse for all the girls. The following poem shows final results:

"THE CHICKEN COOP"

The men have a big warm office,
With plenty of room for their feet;
But we have nothing to keep us warm,
'Mid winter snow and sleet.

Now some of the men had faces kind;
A few were nice and tall;

But *all* were pleasing to the eye,
Compared with this coop's white wall!

But here's to the dear little chicken coop,
Where everything goes dead wrong.
And, believe me, 'twixt summer and winter,
How, pray, can we last long?

—B. E. N.

HEART-TO-HEART TALKS

We take this opportunity of thanking Mr. Gamble of New York for "putting us wise" to the invisible ink which his sub-warehouses are using when writing their contributions for the News.

Our Associate Correspondents at Savannah, Birmingham and Nashville are hereby instructed to use indelible pencils from this date forward when they feel that it is necessary to send in a News contribution.

B. A. Thaxton and J. G. Evans, of our shop, have returned from the border. Both of them gained about twenty-five pounds apiece while they were away and are looking fine. Their Regiment, the 5th Georgia, is on duty in Atlanta and we see them occasionally.

What a grand thing for our board of editors that none of the News correspondents are Chinamen—you know things of this kind are handled right up to date in China. If a contribution is refused by a Chinese editor, it is a very serious offense; in fact, it generally results in bloodshed and is rarely ever done. Unless things improve we may have to hire some Chinamen in Atlanta.

Bring on your Chinamen!—Ed.

Pittsburgh

I. B. Stafford, Correspondent

Recently we wrote up a ticket billing the Western Union Telegraph Company for 227 feet of floor space. This ticket reached our stock room and the hands of one of our selectors. He began searching around among the bins for some floor spaces. Unable to locate a stock, he referred the ticket to his superior for instructions. On account of congested business conditions, we were entirely out.

The Weco Club of the Pittsburgh House finished its basketball season very successfully, winning every game. All spare time is now turned to baseball, a captain and

manager having been elected and practice being regularly held. Our season opened on April 28th.

The club members were guests of the North Side Y. M. C. A. at a supper held on March 26th. As the object of the club is to develop the boys both mentally and physically, we have made a start in this direction by organizing classes in Penmanship, Electricity and Dictation, members of the Company volunteering to coach us.

(To Ed.:—When we try a thing we go through with it.)

WECO CLUB,
H. T. Berner, Secretary.

WELL, WHAT PROGRESS!

Here is one of our latest shop orders:

"Shop make.

"Five wooden men to take place of shop basketball team, which was defeated in all games by office team.

"Finish to be of green pole paint with broad yellow streaks.

"Can not make in shop. Can not find wood hard enough for heads. P. JONES, Shop Foreman.

"Order heads on Duquesne Marble Co. If they can not furnish, try to get ivory at Brunswick-Balke-Collender Co."

Kansas City

G. R. Ryder, Correspondent
OLD OR OVERSTOCK!

Western Electric Company, Inc.

DEAR SIR: I have a number of names and addresses of married ladies in Kansas City which I will sell at twenty-five cents per hundred. If you can make use of them, state the number desired in your letter.

Yours sincerely, A. OLD.



OUR NOTION OF A NEWSY PICTURE

The Girls of the Kansas City House Made a Beautiful American Flag to Fly Over the Western Electric Building—and Made It on One of Our Portable Sewing Machines

1st: *Note the flag*—This "Old Glory" is a distinct Western Electric product. It was made by Western Electric girls. It was made on a Western Electric sewing machine. And it flies daily on a Western Electric branch house.

2nd: Now, look at the girls. Their names are as follows, reading from left to right: Misses Gregg, Nolan, Olive, Banning, Mahoney, Blankenfeld, Madden, Fromholz, Weatherhogg, O'Gara (sitting), Brakebill, Kelly, Condon, Wheeler, Kelly, Swartz and Alberts.

Seattle

Jo Sorenson, Correspondent

When Mr. C. W. Chestnut came to Seattle as sales manager he did not find himself among total strangers. Two members of our local organization were former "Omahaans."

The first week in May marks the date of our taking possession of our new offices and warehouses.

For perhaps a decade old No. 907 has been occupied continually by electrical concerns, and for many years just prior to our occupancy the local power and light company had its offices and shop here. The new "For Rent" signs will mark the passing of one of Seattle's land marks.

Philadelphia

L. R. Browne, Correspondent

My desk is piled high with orders and papers,
 My incoming basket is full to the brim;
 I cannot find time for rhetorical capers,
 That's why Philadelphia's space, lately, looks thin.
 It's funny how the News comes out just the same.—Ed.

The Philadelphia Western Electric Bowling Team, consisting of W. J. Segelken, J. V. Barnwell, H. E. Loucks, C. W. Wiest, C. H. Tewes and S. Lane, is leading the Bell Telephone Company League by a wide margin, and is also tied for first place in the Industrial League of Philadelphia. In addition, they won several independent matches, and are still going at top speed ready to meet all comers—including New York. The standing in the Bell Telephone League is as follows:

Club	Won	Lost	Pct.
Western Electric	23	1	958
Plant Accounting	17	10	629
Commercial	17	10	629
Plant Engineering	14	10	583
Commercial Colts	13	14	481
Maintenance	10	17	370
Construction	7	20	259
Publicity	4	23	148

Cincinnati

D. E. Smith, Correspondent



D. E. Smith, News Correspondent

On March 11th a tornado passed through Hyde Park—a suburb of Cincinnati—and left a path of destruction and ruin, beautiful dwellings were blown over and leveled to the ground as though made of paper, street car traffic and telephone service were put out of commission. The tornado hit with such force as to snap off

twelve 30-foot poles, one of them being carried as a ramrod with the wind and passing entirely through a frame house. The telephone company's men were unable to locate the wires from the pole.

The house, which our Mr. Wolfstyn recently vacated, was blown over, and another house a few doors away, formerly occupied by a Western Electric employee, was completely demolished. Luckily our friend Wolfstyn moves around a bit, nevertheless he is a good storm dodger.

RELAY'S WORKING

During a heavy sleet storm last week, Mr. Milnor received a long distance telephone call from Lima, Ohio. The man on the other end, a wire chief, told Mr. Milnor he had received a call from Mr. Quatman, of the Lima

Telephone Company, requesting that an order be placed with the Western Electric Company for some line material. When Mr. Milnor asked to be connected with the telephone company he was advised that all direct lines were down and Mr. Quatman had to travel fourteen miles over a country road to get in touch with him.

CLUCK-CLUCK

In order to demonstrate the real value of the C 2 Mazda, we fitted up our window to represent a chicken yard and placed four chickens and a rooster in it. The time switch failed to work and the bright glare of the Daylight Lamp kept the chickens from roosting until midnight when the night watchman turned out the light.

POSSIBLY

We received a letter recently from a mining company stating that delay in shipping material on our several orders was due to their minds (mines) being flooded. Possibly they had water on the brain.

St. Louis

A. C. Cornell, Correspondent



Our Exhibit at the National Household Gas and Electric Show

The accompanying picture shows our exhibit in the booth of the Union Electric Light & Power Company at the National Household Gas & Electric Show held at the Coliseum recently. The display consisted of a full line of Western Electric-Hughes ranges, also a large bake oven. In addition to this we had on display in the booths of three electrical dealers, a full line of Western Electric household helps, including washing machines, dish washers, sewing machines, vibrators and heating devices.

The show was a success from both attendance and sales standpoints. There were over two hundred thousand persons who visited the display during the two weeks. In the display the cooks were of different nationalities—French, Swedish, English and an old colored mammy—who cooked foods of the various nations represented.

The last issue of the News, referring to St. Louis' position in the population ranking of cities of the country, put us in fifth place. Of course, we of St. Louis cannot permit such a statement to go uncorrected.

Just to settle this dispute we have dug up the latest census figures available and hereby officially announce that the cities rank thus: 1. New York; 2. Chicago; 3. Philadelphia; 4. St. Louis.—Ed.

San Francisco

C. L. Huyek, Correspondent

Baseball scores make their familiar seasonable appearances in the News. They're all champs, we guess, or the

scores wouldn't be printed—or even reported. But we doubt if any of these Western Electric Leagues can point to a greater star than our Peter Diehl, whose notable batting average of .455, gained last year as one of the smallest and youngest Sunday bushers, secured him a trial with the Oakland team of the Pacific Coast League, a class AA organization that is well known to readers of Ring Lardner and Charles Van Loan.

So join us in wishing the kid luck and a chance to perform on *your* home grounds.

UXTREE!

FIRST ANNUAL PICNIC OF THE EMPLOYEES OF THE WESTERN ELECTRIC COMPANY, SAN FRANCISCO

PINEHURST, May 19, 1917. (Via Oakland and Antioch.)

You and your friends are cordially invited to attend and participate. Consult your nearest traffic manager for rates.

- Are you eligible for the 200-lb. sprint?
- Can you drive a nail without yelling for arnica?
- Do you foxtrot a la Meadowbrook?
- Can you still smile when your best girl is one-stepping with one of our never-home roadmen?
- You don't really mind a few spiders in your lunch, do you?
- Remember: May 19, 1917, will be a holiday.

New York

H. H. Gamble, Correspondent

Show your face—picture passes, please! Hey you! Your pass—show your pass—your face—your commutation ticket or laundry check—anything to get in. Hurry up! There're only two lines of people, down to Christopher Street behind you. All right, go ahead.

Such is the life at "463." After fighting the winds, on the windiest street in the world—that reverberate with cyclonic vehemence around your eyebrows—you just manage to squeeze in the door, and in front of you is a whole ferry boat load of Jerseyites. It is dangerous—you are apt to suffer from a stitch in the side, especially as you are hemmed in by a crowd. You take off your gloves, unbutton your coat, dive into your pockets (if you're of that

sex) for your handkerchief, and while wiping the dust from the river out of your eyes, you use your one free hand searching for your face. You feel it, pull it out, show it and pass on. After you have finished gardening about your eyes you start to return it when you notice that you have shown your commutation ticket. Great system that—couldn't be better.

W. T. Walker—"Say, J. J. R., I might not be in tomorrow as I shall probably have to go to New Haven. If I do, I'll send you a note."

J. J. R.—"Never mind, I saw the note on your desk this morning."

J. J. Raftery won a prize offered by the Jovian Society for the candidate securing the greatest number of new members. The rumor has it that he won a watch, and upon showing it to Dinny, remarked that it was an eight-day watch.

"And faith, w'at is an eight-day clock?" says Dinny.

"Why, it runs for eight days without winding."

"Holy smokes, and how long would it run if ye wound it?"

There's no estimating. A very long time indeed—perhaps for a period equal to that elapsing since the first time this joke was sprung.—Ed.

The Township of South Orange, N. J., placed their lives in the hands of our Credit Manager, W. E. Rice, by choosing him from many to guard their water supply one night.

Could *anything* be safer than that?—Ed.

'Tis said that in heaven the gates are ajar,
 And to get by St. Peter is easier by far,
 Than to pass the grim portals of "463,"
 Where your "Passe Partout" St. Patrick must see;
 Who watches for man or maiden or lass,
 A trying to get through without the pink pass.

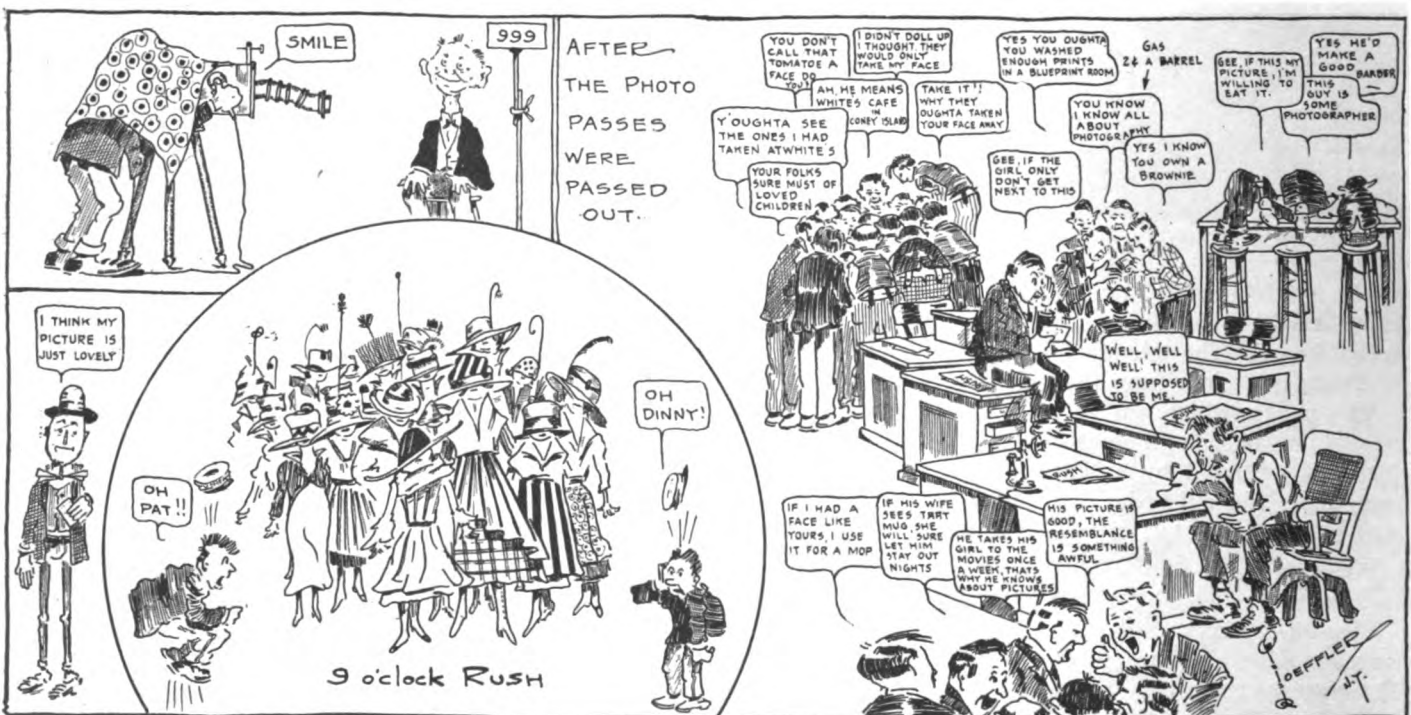

Cleveland

W. H. Quirk, Correspondent

Thomas J. Wheatley, the banker of the Cleveland organization, was the proud recipient at Christmas time of one chinchilla collared broadcloth overcoat of the pattern once favored by other footlight celebrities, notably E. A. Sothorn. Now go on with the story.

When Al Jolson's own show made Cleveland several weeks ago Tom put off getting tickets for the Saturday matinee until Saturday morning. The young man at the box office assured him that they were "just out," whereupon Mr. Wheatley stood up very straight and asked for Mr. Jolson—and Mr. Jolson stepped forward from the lobby where he was interviewing a reporter. The nerve that has never failed a Wheatley—yet, came to his rescue, and this is the conversation as recorded by the reporter:

Mr. Wheatley: "This is Mr. Wheatley. The boy tells me that we are sold out for to-day."

Mr. Jolson (business of shaking hands): "I'm sorry, Mr. Wheatley, but that is true."

Mr. Wheatley: "Mrs. Wheatley will be greatly disappointed."

Mr. Jolson: "I am indeed sorry—"

Mr. Wheatley (buttoning up of coat and expanding his chest): "Well, don't you recognize the profession?"

And it is reported by the interested reporter that Mr. Wheatley got his tickets.

Chicago

R. F. Young, Correspondent

City Limits

Speeders Welcome

The above unique sign, discovered by our farm-light specialist on disembarking from a train at Valparaiso, Indiana, ought to be a welcome sight to any motorist under certain conditions. But the sign at Valparaiso is a bit ironical in its significance because it is at the foot of an extra steep hill leading up into the town.

Here's a little story 'bout a little one-horse town,
That had been asleep for quite awhile, and always wore a frown.
The merchants didn't seem to care, how hard or dull times grew,
So days, and days, and days, slipped by, as days are wont to do.
There was no progress in the town, no hustle "pep" or "go,"
The people seemed to care for naught, a "live one" had no show—
If anyone should come along, with notions bright and new,
He then and there, forthwith would be, a man who was taboo.
Well, time passed on, the town remained the same old sleepy place,
Until a man, an error made, and put it in the race.

The Western force was busy, as the said force always is,
For it's ever on the hop and jump, to land and hold the "biz."
The time for mailing catalogs had come and gone, and yet,
There was a man who had been missed—an accident, you bet.
His name had been affixed all right, but somehow in the hurry,
His book was mailed to Slowtown, which caused him lots of worry.
This yarn is not about the man, but it concerns the town,
The town that had been fast asleep and always wore a frown.
Where merchants didn't seem to care how hard or dull times grew,
Where days and days, and days slipped by, as days are wont to do.

The daily train had just pulled out of Slowtown's little shack;
Upon the platform lay the mail, in a regulation sack.
The misdirected catalog was in that bag enclosed,
But it had a mission to perform in the town that always dozed.
No owner called to claim the prize, so the P. M. gave a look,
And saw the many, many things we've listed in the book.
It wasn't long before he'd shown HIS book to all his neighbors.
They couldn't help but understand that WE'D reduce their labors.
That little town, where merchants slept with lethargy, is through,
And days and days no longer slip, as days are wont to do.

—F. F.

A requisition for some office furniture recently from a storekeeper at one of our sub-warehouses was held up for more information, as sometimes happens. The storekeeper was asked for a "convincing story as to why the expenditure should be made."

His reply follows:

"A few days ago one of our boys inadvertently opened one of the windows on the windward side of the room and one of the desks that I had planned to replace blew over and collapsed. Mr. Tincer tried to get out of the way and bumped against the table which went the same way because it depends entirely upon three legs. I had planned to replace this table with one of those on the order, the other one was intended for Mr. Stewart. I



A "Reel" Love Affair



A Thing of Beauty Is a Joy Forever as Exemplified by All the Girls in the Chicago Office in a Picture Posed Especially for the News

thought it would be better to give him a new table rather than build a second story on his desk."

The auto-bug is certainly rampant at Chicago and its sub-warehouses this year. The "get-away" of the autoists at 5:15 P. M. from our building is actually an acute problem these days. The methods department at headquarters was asked for suggestions. Their recommendations after scratching their heads for several days were to either widen South Clinton Street or to send the cars away in groups at three-minute intervals at night—the Fords at 5:15 P. M., the Overlands at 5:18 P. M., etc.

Those New York banquets. How versatile and up to date they are.

Just imagine, if you can, parodies being sung in this day and age to those post-bellum tunes of *School Days* and *Every Little Movement Has a Meaning of Its Own*. Is there any place where that sort of a thing would be permitted outside of Manhattan without the interference of the police?

No! Never!

Wonder how they happened to pass up *The Sunshine of Paradise Alley* and *Bedelia*? We don't pretend to be a lot of spring chickens out here at Chicago but we do protest vehemently against the resurrection of one-time popular airs that have been dead, decomposed and turned back to ashes for fifteen years.

"Full many a flower is born to blush unseen and waste its fragrance on the desert air."

The above is said to be the finest sentence in the English language. The expression is approximately 200 years old, but it might have been applied to the sugar beets on the 20,000-acre farm of the Owasso Sugar Company of Verne Junction, Michigan. The sugar beets may continue still to waste their fragrance on the desert air of Michigan,

if it can so be considered, but they certainly will not have a chance to blush unseen in the future for the Chicago house has just sold a special farm-lighting plant to the Sugar Company to light its 60 buildings, various driveways, etc.



We have with us, on the left, Carl M. Updegraff, Assistant Buyer at our Cleveland Telephone Warehouse, who has been leader of the Cleveland Telephone Company's orchestra for the last two years. In March, the Cleveland Telephone Company produced a musical comedy, "*The Wonderful Thinkaphone*," which is said to have been the best show ever put on by the Bell people in Cleveland.

The orchestra took a prominent part and had all the earmarks of a professional crowd.

SERGEANT SCHLEICHER!



Just back from the Mexican border after a campaign of nine months amid the cactus, sage-brush and jack rabbits and side-stepping horned toads and rattlesnakes of the Texas plains when "BANG" went the Declaration of War with Germany. That is the experience of B. A. Schleicher, of our Cleveland Telephone Warehouse, who left us a private in June, 1916, and returned a Sergeant in Company A, 5th Ohio Infantry. Sergeant Schleicher was in service in Texas the longest, we believe, of any employee of the Western Electric Company. He

is an authority on trench digging and hiking with the thermometer 92 degrees in the shade and says that he is ready again to serve for Uncle Sam.

GEO. M. COHAN'S YANKEE DOODLE DANDY AS SUNG BY CHICAGO
EMPLOYEES OF GERMAN DESCENT

Ich bin ein famoser Jankee Doodle
Jankee Doodle seien oder sterben—
Mein Onkel's Sam echter Näffe
Geboren am July den vierten.

Hab ein Jankee Doodle Schätzchen
Sie ist meine Jankee Doodle's freude—
Jankee Doodle ging nach London
Um ein Ponsy Spiel zu spielen
Ich bin der Jankee Doodle Knabe.

Chorus

Du bist eine Stoltze Fahne
Die sich hoch empor erheb't
Irgend wo to täht'st wehen

Bist das Sinnbild
Des Land's, ich liebe
Das Heim der Freiheit und des schönen—
Jedes Herz schlägt—Treue
Für das Roth—Weiss—Blau—
Und beim prahlen und loben
Sollen alte Glorien auch nie vergessen bleiben
Blicke auf zur schöner Fahne!

The feature of the April number of the NEWS, so far as Chicago office employees were concerned, appeared on the back page. It is the practice at Chicago to address the office copies of the NEWS on the Addressograph, using the payroll lists of plates with a cut-off arrangement to obliterate the salary. The boy who ran off the names failed to use the right kind of a cut-off so that it was possible for each employee, by holding the back page of the NEWS to the light, to determine whether he got a raise or not in advance of the official notification which followed a week later.



An Advertising Adventure

“WE must have a Sunbeam Lamp Ad.,” says the boss, “and pretty quick.” Five minutes for thought—business of grabbing the telephone—calling up a photographer and indulging in conversation as follows:

“Say, we have to get up a Mazda Lamp Ad. I have an idea in mind of a great big Mazda Lamp above the sky line of lower Manhattan showing the windows of the skyscrapers illuminated after dark. Can't get a stock picture anywhere in town, so to-night at 6 o'clock meet me downstairs, and we'll take a photograph from the Jersey shore after the buildings are illuminated and the Woolworth and Singer towers lighted.”

At 6:15 the photographer, with a boy to help carry paraphernalia, and I stepped onto a Hudson Tube train, en route for the Jersey side to take a photograph, which, under ordinary conditions, would be difficult to obtain owing to the lights from the passing river craft and the distance from Jersey to the lower Manhattan shore.

With the wind blowing a gale and the temperature down to about 10 above zero is trouble enough. But, the worst was yet to come. Emerging from the Hudson Tubes, and stepping out two feet upon the pier nearby, as if by magic we were suddenly confronted with clubs and pistols in the hands of six or more deputy sheriffs and guards. We pleaded to be allowed to take the picture, used police cards, business cards and every other means without avail—each plea met with advice to “get off this pier just as quickly as you can.” We tried to stand along the river front on the avenue skirting the water's edge, but were kept on the move every time we stopped, being followed by policemen and guards. Meantime, people were going home from downtown Manhattan, and lights were beginning to be turned out in the skyscrapers which would soon spoil the night view for a Mazda Lamp Ad.

In desperation, we finally called upon the captain of police at the Pennsylvania Railroad, to see if he couldn't let us take a photograph from the ferry house or the Adams Express pier. He was very courteous but refused. Said he:

“It doesn't make any difference who you are or what your business is, nobody can get on a pier on the Jersey side after dark.”

Finally, our photographer confided that he had taken photographs in the daytime from Colgate's pier. We would try it from there, although it was a little too far down the river. This remark almost brought tears to the eyes of Captain Conley of the Pennsylvania Railroad police, who pleaded and begged us not to. “Boys,” said he, “don't go out on *any* pier,” they will shoot you full of lead. Go back to New York and give up this foolish idea of taking a photograph.”

We held a little council of war, and decided we would have to make a quick run back to New York and try to get a photograph from some of the bridges spanning the East River connecting Manhattan with Brooklyn. But, alas! this plan was doomed, too, for, as the captain assured us, every bridge in New York was guarded by the naval militia and the police department of New York, and if we had ever stopped, especially with those boxes, there would probably have been a decrease of three in the population statistics of the metropolitan district!

Even advertising men sometimes must give up, and we had to admit defeat and abandon the idea—at least while New York and the district around it is an armed camp.

P. S.—Oh, yes, the Mazda Lamp Ad. will appear just the same. There'll be a night view of Lower Manhattan even if we have to fake a view with black paint and white lead from a stock day photograph.

HEARD IN THE SHOPS

ACTIVITIES OF THE MANUFACTURING DEPARTMENT AT HAWTHORNE

Who's Who at Hawthorne



Who keeps the Works accounts, and knows where every penny's gone as well as you do when your clothes have felt wife's touch at dawn? Who plants and 'tends to all the roots whence little routines spring —(and you can bet your Sunday boots he gets *some crop*, by jing!) Who watches with a jealous eye, which nothing can escape, our guaranteed-fast-shades supply of extra-smooth red tape?

Whose name has copped the Smith tribe's fame as Chi's most numerous clan? (Aw, shoot—don't waste time taking aim). That C. L. Johnson man.

A Weigh Off

Of course copper is copper these days, but doesn't this example of ostentatious thrift strike you as rather over-accenting the "con" in economy:

A recent "Material Returned" record sent to the cost figuring section from store-room 6231 credits department 6326 as follows: "Description, No. 22, Bare Tinned Copper Wire. Quantity, .0000075." The cost section, figuring on a basis of \$18.22 per hundred-weight, computes the value at \$0.00, thus short-changing 6326 by a little over one one-hundredth of a cent—13,655 millionths of a cent, to be quite accurate.

Now while they are trying to make change, you can amuse yourself figuring out whether the storekeeper absent-mindedly copied down a pair of washers in front of his figures or whether his thoughts were on the doughnuts he meant to have for lunch.

And the End Is Not Yet

Good night! Philadelphia's Moon has risen and challenged Hawthorne's sons to a correspondence chess match. Luckily our sons are stars and they don't have to set when



Poetical Pete—If He Cared Anything About His Own Safety He Wouldn't Be a Poet



James Shallcross Who Has Taken Up Philadelphia's Challenge to Hawthorne

the Moon rises. Nohow. Contrariwise. Ere the echo of the NEWS distributor's feet had died away in Hawthorne, James Shallcross had snatched up the gauntlet. Viciously licking a stamp, just to get himself into fighting mood, Jim mailed his first move April 6th, and the big battle was on. The NEWS has made arrangements to have reports from the front sent by extra slow freight, so that they won't be too far ahead of the game. Because a chess game is naturally slow; a mail game is naturally slower and a Philadelphia game——

Once more we wish you one and all a fond GOOD NIGHT!

In the Exchanges They All Roll Bull It Is Easy for You to Roll Your Own

The object of running this photograph is not to tempt our young bachelors to avoid the prospective first army draft by becoming war grooms. The real reason for the picture is to show the plate which supports the operator's



transmitter. The backs of the former plates were covered with leather, which sometimes collected dust and soiled the girls' fresh white waists. To avoid this, the part is now backed with a heavy coat of white enamel, which at once shows any dirt that may have collected on it. Well, that's all right, too, except that it makes the plate look more than ever like a white-faced Texas long-horned steer and we have been besieged by numerous "contribs," whose

risibilities were struck by the resemblance. To satisfy them we are sharing this "bully" joke with those of the Western Electric family who have never seen the plate. But the thing must stop right here. Woe be it to the chap who tries to get us to add anything like, "Speaking of Texas dears, what State was the operator born in?" We are positively through!

Around the Wax Pot

THE CONFESSIONS OF AN ALLEGED CORN-CRACKER

With referencé to our installing stunt at West Palm Beach, Florida, which the NEWS very kindly described for us in the March issue, we feel very much hurt by having our Yankee friends jump to the conclusion in the April number, that we were posing as originators of that "didn't-interfere-with-service" stuff. *Because* the idea of getting our name in the NEWS was suggested by a similar stunt picture in a before-the-war issue of the *Southern Bell Telephone and Telegraph News* wherein a board was moved across an alley. This was in the days of open wire on Broadway.

After having it so forcibly impressed on us that most of those stunts up North were pre-historic we assume they happened before the days of photography—at least trick-photography—so we will not ask the NEWS to smear our Missouri address all over its pages.

We now hasten to our confession before we are caught again. Our pictures were fakes and cost us \$3.00. The board was not really raised at all. The exchange is located in the edge of the Everglades, and the ground being soft we merely pulled the building, which is of solid concrete, down into the ground the required distance. Furthermore, and to our discredit, the building skidded about 1/100 inch and the ringing control clock mounted on the cable turning section missed a tick and paralyzed the ringing system for most a second. The balance of our nefarious work has been well obscured, so we won't confess any more, at present.

As a final request we ask whom it may concern to look up the early history of that roof-raising job, which was thrown at us, and which we assume was at Williams Bridge, N. Y., and see who the real instigator was. Please make the investigation thorough—we mean way back when the Bell engineers were wondering how they were going to increase capacity—and see if some alleged corn-cracker now in the Southeastern district did not help lay the foundation on which our censors stand and proclaim their superiority.

[Signed] E. ARNOLD.

GO WEST YOUNG MAN AND LEARN "SPEED"

It has been rumored in the East that a certain general foreman operating beyond the confines of the Eastern District was so delighted with a certain gang of his that he opened negotiations with a moving picture concern for several hundred feet of film, only to be informed by the representative of said M. P. C., who had watched the gang at work that stereopticon views would be more appropriate.—J. J. Clifford, *New York*.

Western Electric News

PUBLISHED
MONTHLY

FOR THE
EMPLOYEES

BY THE WESTERN ELECTRIC COMPANY, INCORPORATED

H. B. Thayer, <i>President</i>	H. A. Halligan, <i>Vice-President</i>
W. P. Sidley, <i>Vice-President</i> and <i>General Counsel</i>	A. L. Salt, <i>Vice-President</i> and <i>Gen. Purchasing Agt.</i>
Gerard Swope, <i>Vice-President</i> and <i>General Sales Manager</i>	H. F. Albright, <i>Vice-President</i> and <i>Gen'l Superintendent</i>
J. W. Johnston, <i>Treasurer</i>	F. B. Jewett, <i>Chief Engineer</i>
G. C. Pratt, <i>Secretary</i>	R. H. Gregory, <i>Comptroller</i>
C. E. Scribner, <i>Consulting Engineer</i>	

Office of publication and address of President, Secretary, and Treasurer, 195 Broadway, New York City.

BOARD OF EDITORS

P. L. Thomson, <i>Editor-in-Chief</i>		
P. K. Condict	E. C. Bstep	S. W. Murkland
W. F. Hendry	F. J. Holdsworth	H. D. Agnew
John Colter		Reed Calvin

Subscription: \$1.50 per year, except to employees of the Western Electric Company, to whom copies are furnished free of charge.

All communications and contributions should be addressed to WESTERN ELECTRIC NEWS, 195 BROADWAY, NEW YORK.

Matter intended for any given issue must reach New York not later than the 12th of the preceding month.

VOLUME VI MAY, 1917 NUMBER 3

THE RIGHT MAN IN THE RIGHT PLACE

WE ARE at war—not simply that intangible “Government at Washington,” but all the people and all the institutions of the United States are at war. You and one hundred odd million other citizens, the Western Electric and thousands of other industrial companies, are at war.

While none of us are likely to forget that, it is possible that some, out of an entirely praiseworthy spirit of patriotism and responsibility to the nation, may, upon impulse, rush to shoulder some military burden for the Government—and leave a more important work behind. Englishmen made this mistake. Before England's flag had been long in the field she was bringing thousands of her soldiers back from the trenches because, although they were the right sort of men to fight, they were fighting in the wrong place. Back home in the factory they could do, and thereupon did do, much more for their country than was possible for them at the front.

We of the Western Electric often refer to our salesmen as the men who work “on the firing line.” We all realize the necessary of keeping them well supplied with goods to sell—with “ammunition.” Now we must recognize that adequate and efficient means of communication for a nation at war or for an army and navy in the field constitute a most essential part of its equipment. How important, therefore, that the

Western Electric Company—an inherent part of a system which is vital to the communication life of the country—should remain in a position to meet every military need of electrical requirement.

Particularly because this is an electrical war. It is said that twelve thousand British lives were lost at the Battle of Villa Neuve—because of a broken field telephone wire. The British soldiers advanced beyond their positions so far that their own artillerymen (unwarned because of the broken line of communication) annihilated them. Aviation and the wireless, together with the operation of battleships themselves and the control of gunfire, and many other developments of war depend upon electrical equipment.

The men on the fighting line are no whit more important than the men in the shops or factories. It is, possibly, more romantic to throw hand grenades from a concrete trench—although Irvin Cobb says that romance in war has perished. But, it may be a great deal more efficient war-making to stay home and continue with your work of helping make for the Government equipment that it needs. Whatever may have won other wars, this will be won only by the long, hard pull of the *right* man in the *right* place. The principles we are fighting for will triumph only if we respond loyally to a paraphrase of Lord Nelson's famous slogan of the sea: “America expects every man to do his duty—and, do it in the right place.”

WANT ANOTHER HOUR OF DAYLIGHT?

A CORRESPONDENT asks the News how he can register his vote in favor of the plan to move the clocks of the nation ahead one hour. The News' information is that the bill to this effect, which failed of passage in the last session of Congress, has again been introduced, and, strongly backed, will be brought to a vote. As a war move to conserve the nation's supply of coal, gas and electricity, this plan has much to commend it. The European nations which last year inaugurated it have, without exception, continued it this summer.

There are inherent difficulties in one organization attempting by itself to arrive at this result, for then it would mean an actual moving of the working hours ahead. The thought of arising an hour earlier than you are accustomed to do—an hour before your friends outside of the Company are doing, is not apt to make a hit; but think of that extra hour in the afternoon for baseball or tennis, or that garden!

The News is for it, not alone as a war measure, but on a platform of comfort, efficiency and common sense. If you are interested, therefore, write to your representative in Congress.

WE GROW

ON April 1, 1917, the employees of the Company reached 29,591, the greatest number in its history, and close to 50% more than were employed at April 1, 1915.



NEWS FROM HEADQUARTERS

Some Items of Interest from the General Departments



General Sales Department

W. A. Wolff, Correspondent

ON SUBJECTS

It must be a job—and a man-sized one—
To find a good subject to lead
The thirty-two pages that go every month
To make up this News that we read.

Though we make it a point not to question or doubt
Our Editors' motives one bit,
That questionnaire, sent out to gather in points,
Means more than we think they'll admit.

Our subconscious ego tells us they were out
Of topics for features and such,
And we'll bet that the questionnaires seemed like the straw
At which drowning men try to clutch.

So out of the goodness that dwells in our heart
We're going to offer a few
To follow the one on how cross-arms are made.
We hope, oh ye Eds, that they'll do.

"What makes the hot-galvanized cross-arm brace?"
And "Why does the pole support?"
A story that tells "How the guy anchor guys,"
With more of the self-same sort.

"The real inside story why can't hooks can,"
And "Why lag screws lag when they're good";
"The history of wire" on multiple reels;
We could give many more if we would.

But these will suffice. If the Board should wish more
That are equal to these or still better,
We are willing to help for the good of the cause
They can reach us by card or by letter.

—W. A. W.

It has been a job—and a man-sized one—to find good subjects, W. A. W., but it never will be again. Instead of wasting 20,000 good sheets of paper on questionnaires, we'll simply howl the traditional cry of "Wolff! Wolff!"—and watch ideas flow in!—ED.

ANOTHER EMPTY DREAM

Once upon a time, we looked upon the West as a place where everyone spent money with a free hand. When we read W. M. G.'s verse last month about using the Chicago column of the News to save postage—bang went another one of our few but cherished illusions.

INTRODUCING OUR NEW SALESMAN



George and the Washer and the Check

George Schmidt, formerly the factotum of the V. P. and G. S. M. and now custodian of the Exhibit room at 195 Broadway, made a real sale the other day. Of course, George has been expounding the merits of our goods to other employees and making sales to them. BUT all by himself, he landed a washing machine prospect and sold him one of the \$100 washers. George, the cheque and the machine are shown in the accompanying photograph taken by the light of a Western Electric Flood Lamp.

GETTING THE RIGHT ANGLE

It was indeed a lucky thing for the General Sales Committee that it had an expert photographer to take that banquet picture. Otherwise it would have been a very good photograph of those two little chaps, "Cap" Merrick and Bill Lindsey. An X-ray *might* have found the others.

ON DUTY FOR THE U. S. A.

The call to arms has already claimed one of our boys, Clarence O'Neil, of the Advertising Department, who is now serving with the New York Naval Reserve in Philadelphia. This is his second tour of duty within a short time. A few weeks ago he helped guard one of our bridges and the weather wasn't any too propitious at that.



MARRIED

February 10th.—Mary Jelinkova, of department 7381, Hawthorne, to James Loula, of Chicago.

March 14th.—Gladys Lillian Brady, of department 7154, Hawthorne, to Joseph Cotey.

March 17th.—Anna Drazin, of department 7381, Hawthorne, to Joseph Korbel, of Chicago.

March 20th.—Amanda Berg, of department 7393, Hawthorne, to Herman Pasche.

March 22nd.—Arthur Smith, of department 7176, Hawthorne, to Dolores Hartley.

April 7th.—Sophia Ellys, of department 7381, Hawthorne, to Gottlieb Hartwig, of Forest Park, Ill.

April 28th.—Helen Nogel, of department 7393, Hawthorne, to Richard Roehrig, of Chicago.

May 2nd.—Florence Lonergon, of department 7037, Hawthorne, to O. W. Sandberg, of Chicago.

·BY·
HAWTHORNE · E · A · ATHLETICS
 ·MEMBER·

Hawthorne Golf Club

THE Hawthorne Golf Club formally opened its season on April 28th at the Harlem Golf Links, with a membership of approximately seventy-five. The executive committee has outlined twelve tournaments, which will keep the players busy until the snow flies.

About \$150 worth of prizes, consisting of balls, clubs, merchandise certificates and silver cups have been hung up, so that everyone has a chance of participating in the prize list. The schedule follows:

- April 28th..... Blind Bogey Handicap-Medal Play
- May 12th..... Individual Handicap-Medal Play
- May 26th..... Handicap Match Play Against Bogey
- June 9th..... Individual Handicap-Medal Play
- June 23rd..... Handicap-Match Play—1st Round
- June 30th..... Handicap Match Play—2nd Round
- July 7th..... Handicap Match Play—Finals
- July 7th..... Handicap Medal Play—Two-Men Teams
- July 21st..... Handicap Challenge Match Play—1st Round
- July 28th..... Handicap Challenge Match Play—Finals
- August 4th..... Mid-Season Handicap—Match Play—1st Round
- August 11th..... Mid-Season Handicap—Match Play—2nd Round
- August 18th..... Mid-Season Handicap—Match Play—Finals
- August 25th..... Scotch Foursome
- September 8th... Hawthorne Championship and Sidley Cup-Scratch Qualifying Round—Medal Play
- September 15th... Hawthorne Championship—1st Match Round
- September 22nd... Hawthorne Championship—Semi-Finals
- September 29th... Hawthorne Championship—Finals
- September 30th... Country Club Outing
- October 6th-27th.. 36-Hole Handicap—Medal Play

Commercial League Baseball Season Opens

The 1917 baseball season of the Commercial League opened April 28th, for which date the Western Electric team drew a bye. Our complete schedule follows:

- | | | |
|----------|-------------------------|------------------------------|
| April 28 | Bye | vs. Western Elec. Co. |
| May 5 | Western Elec. Co. | vs. Wilson & Co. |
| 12 | Illinois Tool Co. | vs. Western Elec. Co. |
| 19 | Western Elec. Co. | vs. Stewart Warner Speed Co. |
| 26 | U. S. Ball Bearing | vs. Western Elec. Co. |
| June 2 | Western Elec. Co. | vs. Bye |
| 9 | Wilson & Co. | vs. Western Elec. Co. |
| 16 | Western Elec. Co. | vs. Illinois Tool Co. |
| 23 | Stewart Warner Sp'd Co. | vs. Western Elec. Co. |
| 30 | Western Elec. Co. | vs. U. S. Ball Bearing Co. |
| July 7 | Bye | vs. Western Elec. Co. |
| 14 | Wilson & Co. | vs. Western Elec. Co. |
| 21 | Stewart Warner Sp'd Co. | vs. Western Elec. Co. |
| 28 | Western Elec. Co. | vs. Illinois Tool Co. |
| Aug. 4 | U. S. Ball Bearing Co. | vs. Western Elec. Co. |

Bowling

The Western Electric Inter-Department Bowling League brought its 1916-1917 schedule to a close on Thursday, March 29th, the final game showing the Machine and Jobbing Department's team the winner by a margin of four games over the Switchboard Department's team. At the beginning of the season the Production and Merchandise team led by a good margin, but due to the loss of one of their best bowlers and the strengthening of the other teams, they finally landed in third place, eight games behind the leaders. The winners fought their way into the top position about the middle of the season and

stayed there to the finish, although hotly pressed at all times by their nearest competitors, the Switchboard team, who finished the season with an average of 901 81/84 pins per game, against 901 27/84 for the winners.

The Machine and Jobbing team was composed of J. Larson (captain), G. Voss, P. Lindberg, O. Skoog and O.



*Machine and Jobbing Dept.'s Team, Champions Season 1916-1917
 O. Skoog O. Pearson P. Lindberg J. Larson (Capt.) G. Voss*

Pearson. The anchor on the team was Gus Voss, the individual champion of the league, who bowled the splendid average of 191 46/75 in 75 games. The rest of the boys on his team tried to keep pace with his scores and consequently brought up the general average of the team. Besides being a star bowler, Gus did much to keep up the spirit of the team by his jolly nature. O. Skoog landed in fifth place with an average of 185. John Larson, the captain of the team, made eighth place, with an average of 184. O. Pearson's average of 177 put him in twentieth place, and P. Lindberg ended thirtieth with an average of 173. O. Skoog made the high game score of the season, which was 258.

The Works Clerical team landed in fourth place. At the beginning of the season they seemed doomed to one of the cellar positions, but they showed a wonderful spirit at the half-way mark and from then on were considered a strong team. G. Callender, of this team, carried off the prize for the high average for one night—220½ average in three games bowled. The Switchboard boys, besides

averaging 901 for the season, secured the high average for one night, 980 1/3; also the high team game for the season, 1,033. The latter score was bowled on the last night of the schedule, beating the score of 1,030 held by the Machine and Jobbing Department team.



G. Voss, Hawthorne's Individual Bowling Champion

The Inspection Department team did not keep up its reputation of former years, but landed in fifth place, although still lead by its old warrior, "Bill" Teichtler, who bowled his usual pace of 173. E. Shoda, who always has been the mainstay of the team in former years, dropped to twenty-third place, with an average of 176. Last year his average was 185.

The last year's champions, the Technical Department team, landed in sixth place, largely through the loss of E. Knoke, their former captain, who was transferred to the C. R. & I. Shops. The Engineering Department team kept up their usual pace of 840 average and only landed seventh place, although Al. Pruessman was still on the job with an average of 184 for the whole season. The C. R. & I. Shop team got cold feet at the half-way mark and was supplanted by the Installation Department team.

The Installation boys promise a real team next bowling season, this being their first taste of league bowling. At that they took games away from the other teams. The members of the Machine and Jobbing team and the individual champion will receive gold medals with Western Electric monograms.

WESTERN ELECTRIC BOWLING LEAGUE (INTER-DEPARTMENT)
Final Standing March 30th, 1916

Team	Won	Lost	Total Pins for Season	Average
1. Machine and Jobbing.....	57	27	75711	901 27/84
2. Switchboard	53	31	75765	901 81/84
3. Production and Merchandise. 49	35	35	73583	875 83/84
4. Works, Clerical.....	48	36	71711	885 26/81
5. Inspection	48	36	72971	868 59/84
6. Technical	37	47	73055	869 59/84
7. Engineers	32	52	70900	844 4/84
8. Installation	12	72	64126	791 55/81

High average for 1 night—Switchboard 980 1/3.
High game for 1 night—Switchboard 1033.

Individual Averages

Name	Team	Games	Total Pins	Average
1. Voss	Mch. & Jobb....	75	14371	191 46/75
2. Davey	Switchboard	57	10630	186 28/57
3. Callender	Works, Clerc....	57	10619	186 17/57
4. LaFont	Works, Clerc....	72	13349	185 29/72
5. Skoog	Mch. & Jobb....	81	14989	185 4/81
6. Fliger	Technical	81	14972	184 68/81
7. Pruessman	English	69	12729	184 33/69
8. Larson	Mch. & Jobb....	69	12718	184 22/69
9. Wehrmeister	Switchboard	69	12679	183 52/69
10. Bezdou	Switchboard	78	14311	183 37/78
11. Adamson	Switchboard	72	13076	181 44/72
12. Dehl	Works, Clerc....	75	13620	181 45/75
13. Jenkins	Technical	78	14128	181 10/78
14. Hort	Prod. & Misc....	81	14623	180 43/81
15. Heslin	Prod. & Mdse... 81	14540	179 41/81	

High average for one night—Callender—220 1/3.
High game for season—Skoog—258.

Inter-Corporation Bowling Tournament

A "Four-Cornered Bowling Match" was held Wednesday evening, April 4th, at the Illinois Athletic Club Alleys on Michigan Avenue, between teams from the Western Electric Company, Inc., the Chicago Telephone

Company, the Peoples Gas Light & Coke Company and the Commonwealth-Edison Company.

Each team consisted of five men who had qualified by their play in their company leagues. There were two team and two individual prizes. Our team took first team prize, and Mr. O. Skoog of our team took the high average individual prize, with a score of 205 for the three games. Mr. Christensen, of the Chicago Telephone Company, took the high game individual prize, scoring 219 against Mr. Skoog's 216. The results were as follows:

Team	Total Pins
1—Western Electric Company, Inc.....	2838
2—Commonwealth-Edison Company.....	2674
3—Chicago Telephone Company.....	2670
4—Peoples Gas Light & Coke Co.....	2624

The members of our team, with their scores, were:

Players	Departments	Games			Total
		1st	2nd	3rd	
LaFont	Works, Clerical.....	182	160	179	2838
Davey	Switchboard	195	157	177	
Skoog	Machine	216	199	200	
Fliger	Tool Room.....	212	202	186	
Voss	Machine	210	192	171	

Hawthorne Bowling Tournament

The Seventh Annual Tournament for Hawthorne employees was held under the auspices of the Athletic Committee at the Palace Alleys on Thursday, April 5th and Saturday, April 7th, with 96 entered in the singles, and 48 in the double events.

In previous years this tournament was a handicap affair; this year, however, by request of the majority of league bowlers, it was held on a scratch basis.

This tournament has always created considerable interest among employees at Hawthorne, and this year was no exception. The results of the tournament are given below:

DOUBLES

Place	Prizes	Score	Name
1	\$28.00	1230	{ Voss { Nevaril
2	19.20	1191	{ Davey { Callender
3	14.40	1190	{ LaFont { Fliger
4	9.60	1174	{ Klima { Baumgartner
5	7.68	1128	{ Thielen { Horton
6	6.72	1121	{ Teichtler { Fortner
7	4.80	1120	{ Janda { Rehor

SINGLES

Place	Prizes	Score	Name
1	\$19.20	661	Knoke
2	14.40	642	Higgins
3	11.52	630	Lindberg
4	9.60	626	Teichtler
5	8.64	622	Stefani
6	7.68	619	Richter
7	6.24	604	Larson
8	6.24	604	Free
9	4.80	600	Pearson
10	2.88	590	Pruessman

High Two-Man Game—Prize \$4.80—Score 434—Rosar-Moser.
High Game—Prize \$4.80—Score 268—Lindberg.

Activities of the Hawthorne Club

FOR this month the scribe is in the position of the cub reporter who "covered" a society wedding and failed to turn in any copy because the groom didn't show up and there was "nothing to report."

The Girls' Camp

Hold on, though! There is. In fact, there is so much that we'll have to tell it to you in a sort of verbal shorthand.

Girls' camp. To be at Round Lake, forty-three miles from Chicago on the Chicago, Milwaukee & St. Paul Railroad. Cost will be one-twenty-five for the round trip. The Hawthorne Club cottage contains fourteen large rooms, electric lights, running water, two large baths, excellent drinking water, etc. Week rates, \$8 for Club girls; \$9 for others. Week-end rates, \$1.50 for Club girls; \$2 for non-members.

The inspired press agent goes into considerable more detail. For instance, he says:

"The lake has been named by nature, for it is almost as round as if made by man. The banks are high and slope gently to the water's edge, and are covered with splendid groves of live oaks, hickory and basswood. Surrounding the lake are beautiful homes of many Chicago people.

"The bathing features are unsurpassed. Round Lake is fed by springs of pure, clear water and is very deep in places. The beaches are of sand and gravel, and in front of the camp is a sand bar which affords ideal protection. The water here graduates from three to twenty feet deep. A large platform and springboard has been provided. Only 25 yards separate the beach from the main cottage and light showers have been installed in a handy location.

"The surroundings will please everybody. Hawthorne Cottage, located on an elevation, commands full view of the beautiful lake and its park-like surroundings. One of those historical 'Indian Trail Trees' is nearby. All churches are only a short walk from the camp: Catholic, Congregational, Episcopal and Methodist. Auto



Round Lake, Where the Girls' Camp Will Be

livery can be had at the hotel. Several camps of Boy Scouts from Chicago and Oak Park locate near this spot each year. Tennis courts, baseball grounds, dancing pavilion, lawn and pier invite plenty of exercise. Movies and dancing at Round Lake every evening, and a dance at the pavilion on the grounds every Saturday night."

So there you are. We have let it go just as the prospectus put it, even to featuring the Boy Scouts, who are probably good boys and good scouts, too, but a bit too youthful for escorts. However, since girls claim to take vacations, largely to escape the tiresome masculine sex, perhaps that isn't such bad advertising after all.

Anyway, take a look at the shore of the lake. We'll show you some nice close-ups later.



CURRENT AWARDS OF OUR SERVICE BADGES

THIRTY YEARS			
Jacoby, A. L., Hawthorne.....	May	—	
TWENTY-FIVE YEARS			
Guerin, M., Hawthorne.....	May	—	
Klofat, J., Hawthorne.....	May	—	
Petersen, E. B., Hawthorne.....	May	—	
Eiselt, A., Hawthorne.....	May	27	
Beck, W. O., New York.....	May	22	
TWENTY YEARS			
Peterson, A., Hawthorne.....	May	5	
Phillips, R. H., New York.....	May	24	
Tulloch, J. R., New York.....	May	23	
FIFTEEN YEARS			
Stevens, G., Hawthorne.....	May	2	
St. John, C. B., Hawthorne.....	May	12	
Kerwan, J., Hawthorne.....	May	14	
Stone, L. A., Hawthorne.....	May	16	
			TEN YEARS
Cervenka, J., Hawthorne.....	May	21	
Kopp, G. H., Hawthorne.....	May	23	
Peterson, Hannah, Hawthorne.....	May	30	
Todd, J. D., Kansas City.....	May	17	
Bickler, J., New York.....	May	8	
Quirk, John C., Chicago.....	May	13	
Remes, John, Chicago.....	May	23	
Dickson, F. C., Hawthorne.....	May	2	
Parker, G. A., Hawthorne.....	May	3	
Hershberger, E. F., Hawthorne.....	May	5	
Leather, B. H., Hawthorne.....	May	13	
Thurston, E. W., Hawthorne.....	May	22	
Bouchard, W., Hawthorne.....	May	28	
Wiscons, F., Hawthorne.....	May	31	
Chestnut, Charles W., Omaha.....	May	1	
Samacek, John, Pittsburgh.....	May	11	
Lennon, Edward, San Francisco.....	May	15	

A. L. Jacoby, Hawthorne

A. L. Jacoby

Back in 1887, when Andrew L. Jacoby came with the company, there was no central employment office. Each foreman secured his own men. Mr. Jacoby was offered a job by the late William Culley through a friend who had worked with him outside. However, in the time that elapsed before Andy got down to see Mr. Culley, a busy-body had got in his work. This worthy declared that Jacoby was leaving his former employers in a bad hole by quitting them during their busy season. Now, Culley needed men badly, but not badly enough to get them that way, so he asked the applicant to go back and give a month's notice. This, Jacoby assured him, was not necessary, since his former employers, instead of being rushed with work, were in the midst of their slack period, but he finally went back and got a letter from the superintendent before "Pop's" conscience was entirely satisfied. Apparently, both Andy and the letter were perfectly satisfactory, however, for he is still with the company. Also, he still has the letter.

Most of Mr. Jacoby's service has been in the wood-working departments. He was foreman of the box factory for many years. By subtracting 1887 from 1917 you will see that he is now eligible for his four-star button.

M. Guerin, Hawthorne

Generally, a man who looks down on his work does not do a good job, but M. Guerin is an exception. He operates an overhead crane. Mr. Guerin's first work for the company was in the millwright department under Widdicombe. He also worked for awhile in the commutator department when the Western still made power apparatus.

Mike was one of the millwrights that installed the Western Electric Company's exhibit at the Chicago World's Fair in 1893. That was a year after he came with the company, and it was also 24 years ago, so Mr. Guerin gets a 25-year button this month.

[Where
Mr. Guerin's
Face
Would Have
Shone
Had He Sent
in
His Photo]

J. Klofat, Hawthorne

Joseph Klofat, of dept. 7391, knows more of the habits of a machine for stranding switchboard cable than many engineers in the business. The reels are so familiar to Joe that he can call each one by a separate name. While the other fellows are busy trying to start a balky strander, Joe just pats his machine on the neck, whispers some magic words, and away she goes.

Mr. Klofat started his career with the company when 16 years old as a helper of the girl operators on paper insulators. Later he repaired machines, tried press work in the rubber plant, and then took up cable stranding, which has been his line ever since, with the exception of a short period on rubber finishing. This month he will get another star to put with the two on his present service button.



Joseph Klofat

E. B. Petersen, Hawthorne

E. B. Petersen

No, Eloise, a nut-burring machine is not a device for removing the burrs from chestnuts. The burrs it removes are rough particles of metal left by the punch that makes holes in the kind of nuts used to hold bolts and screws in place. If you care for more detailed information on the machine, we shall have to refer you to E. B. Petersen, repair man on special tools at Hawthorne. He helped in the development of these machines and has nursed most of their troubles ever since.

Mr. Petersen came to Hawthorne from the New York shops. Although he has worked in various departments, his duties have always been the same—diagnosing and repairing machine troubles. He gets his 25-year button this month.

A. Eiselt, Hawthorne

Anton Eiselt

One of the men who has done much to make things brighter at Hawthorne is A. Eiselt. Mr. Eiselt is a metal polisher, who began with the Western in New York. Eastern shop men will remember Tony as a member of the buffing department's tug-of-war team in the New York shops in 1910 and 1911. He was transferred to Hawthorne

when the department was moved in 1913. Mr. Eiselt gets a 25-year button this month.

A. A. Peterson, Hawthorne

A. A. Peterson

Statistics don't mean very much to most people. If we told you that altogether the Company has made 5,000,000 subsets, or 50,000,000 subsets, or 500,000,000 subsets, the chances are that you would get no real idea as to how much any of these figures meant. But if you had been turning out subsets boxes constantly, six days in the week for 20 years, and had worked beside dozens of other men, all doing the same thing, you would begin to get some conception of how big a million is. A. Peterson has had that experience, and when you take a one with six ciphers after it and put it ahead of subsets, he has a pretty god idea of how many you are talking about. Mr. Peterson adds another star to his button this month.

W. O. Beck, New York

W. O. Beck

W. O. Beck's career with the Company began about the same time that the great World's Fair began—and in the same place, Chicago. The exact spot was the model shop. Fifteen years later—it was September, 1907—he was transferred from Chicago to New York, still in the model shop. Two years later the Development Branch of "Apparatus Design" claimed him. For the last eight years Mr. Beck has been in that department—a total of twenty-five years' service in the engineering department.

J. R. Tulloch, New York



J. R. Tulloch

J. R. Tulloch drew his first Western Electric pay as a messenger in New York. After several years of clerical work he entered the export sales department and there added copiously to his geographical knowledge. (You never know these foreign countries and cities till you get into commercial touch with 'em.) In 1907 Mr. Tulloch was transferred to the Telephone Sales Department for several years, and in 1909 went with the Foreign Sales Department where he now is. He is one of the men in the Company who has insomnia when the ocean freight rates are aeroplaning—as they often are nowadays. And the upward trend of marine insurance rates in these days of submarines—well, ask any of the Foreign Department people what they think of it.

R. H. Phillips, New York



R. H. Phillips

R. H. Phillips began earning his Western Electric service badge in the Iron Working Department of the shops at New York. Six months later he was transferred to the drafting department where he remained for five years. He was then transferred to the blue-printing department—Engineering Department—where he is now in charge. R. H. Phillips' favorite sport, they say, is arguing.

Denver's Service Badge Contingent



Reading from left to right, back row: M. Taylor, H. H. Argabrite, M. Cassidy, E. E. LaDuke, J. C. Crupper, F. C. Rebell. Middle row: H. W. Dye, A. Brown, E. Neill. Front row: A. T. Slack, E. F. Luscher, W. J. Laufenburg, A. N. White

We do not know exactly the aggregate number of years' service represented in this picture, but we do know that the number of employees at Denver (not including Salt Lake) is 85. Furthermore, that the picture shows twelve men and one lady, or 15% of the total, and while this may or may not be a record, the percentage is probably above the average.

"If we cannot call this showing a record, we are willing to declare that we have one, beyond question, when we list our employees who have five years' service," writes our Denver scribe. "If necessary we will include our Salt Lake City employees to help us increase the number!"

HOLDERS OF 15 YEAR SERVICE BADGES



L. Stone



C. B. St. John



J. Kerwan



J. Cervenah



G. Stevens

Howard E. Coffin on "Business During War"

HOWARD E. COFFIN, of the Advisory Commission of the Council of National Defence—a man well known to many Western Electric people—said recently that he feared that the results of a too enthusiastic rush to enlist for war might harm America's best interests.

His words were:

"Upon the industrial side of the war three great problems—or perhaps I should better say tasks—confront us.

"First and foremost, we must facilitate the flow of raw materials and finished products to our allies, and must provide the means of rail and water transportation therefor.

"Second, we must meet our own great military and naval building schedules.

"Third, we must plan to do all this with the least pos-

sible disarrangement to our own vast commercial and industrial machines.

"Through it all we must keep a close eye upon the possible conditions of peace following the present war. We must insure the business success and general prosperity of the country during the war if we are to hold our present strong place among nations in the commercial competition of the future.

"Patriotic service does not of necessity mean the making of shells or the carrying of a musket over the shoulder. This would soon become a sorry sort of country if it did. There is no doubt of the willingness of any manufacturing plant or individual to serve should the call come. But until the call does come it is best to stick on the job. Let us make 'better business' our watchword and keep our factory fires burning."

Some Weighty Statistics on Cable Output

BEARING in mind how heavy a piece of lead is, you can probably guess how much 7,200,000 pounds of it weigh. In any event, if you will look at the illustration of the Cable Plant lead pits, you can see what that much lead looks like. That ought to cover cable until the war is over, you would think—or say at least a year. Let's see. There must surely be a year's supply there. Because if it was only for a month that would be—2,000 pounds in a ton, aren't there? That would be 2,000 into 7,200,000 or 3,600 tons, don't you make it? Now there would be four times six or twenty-four working days in a month, and that would make twenty-four into 3,600 or 150 tons *a day*. Looks impossible, doesn't it?



Some Pigs Can't Be Led, But These Are

As a matter of fact, it isn't right. The actual average consumption of lead from January 20th to April 7th was 2,200,000 pounds a week—1,100 tons—which your arithmetic will show you make a little over 183 tons a day instead of our little 150 tons.

During these same eleven weeks the average weekly output of cable contained 338,000,000 feet of wire. That means about 64,000 miles or more than 10,000 miles each working day. If the little old flivver could do that much in an eight-hour day over all kinds of roads (including ocean paths), she would carry you around the earth at the equator in about 2 1/3 days.

The largest single week's output of cable was reached during the week ending March 10th. It contained 374,000,000 feet of wire. Just figure that in miles for yourself; we've traveled far enough.

The biggest shipment of cable from Hawthorne was made during the week ending April 1st. It amounted to 177 carloads, 2,267 reels or 3,916 tons, whichever way you prefer to look at it. That shipment was about two times the average shipment during the eleven weeks we are considering; and, as you can well imagine, it required a considerable concentration of men upon the firing line to get it out. The flexibility of the functional organization system at Hawthorne aided decidedly in getting out this immense overload shipment. Under the old plan of organization it would have been difficult to shift the necessary number of extra men required—especially with the shops crammed with work, as they are now.

Now for a few more figures on the cable output and then we'll let you up. The average number of reels used each week from January 20th to April 7th was 1,300. The cable wound on them each week contained 1,000,000 pounds of copper wire. Yes, that makes 500 tons. And *per week* is quite correct. Incidentally, we used 200,000 pounds of insulating paper. Per week also.

There, that's better! It's some relief to get a weight like that off your mind.

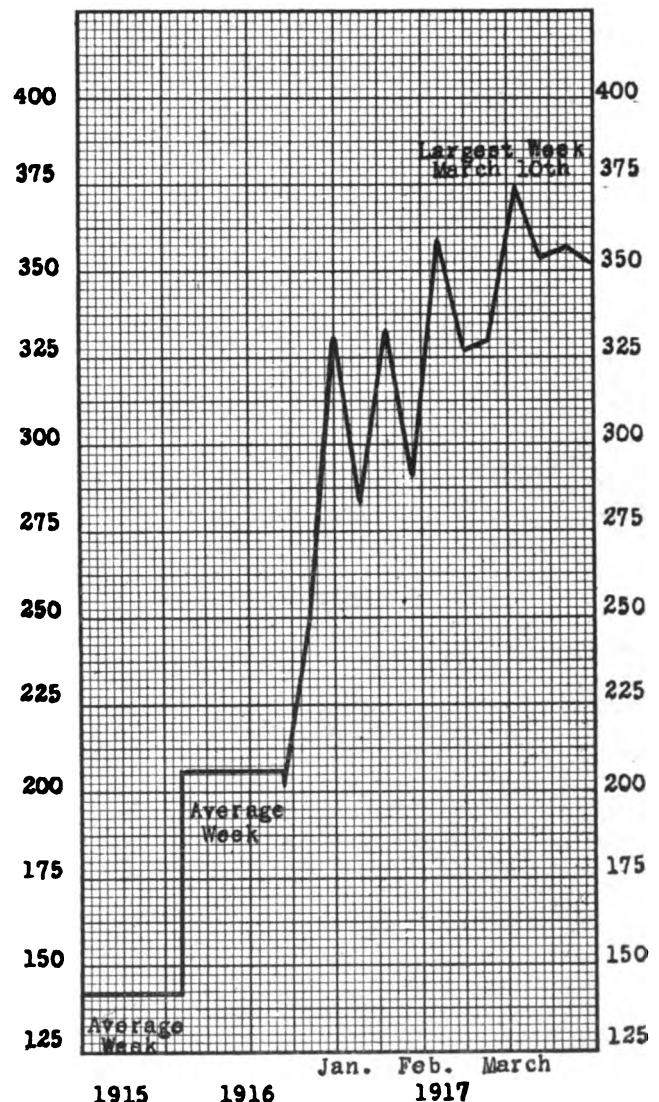

Weekly Output of Land-Covered Cable (Millions of Feet of Wire) for Years 1915, 1916 and 1917

Preparedness Begins in Your Own Garden

BROUGHT face to face with the heavy responsibility of feeding well nigh the whole world, and stimulated by President Wilson's message, the agricultural leaders of the country have launched the Back-yard Gardening Campaign. The boy scouts, we are told, are going to answer for some millions of pounds of food-stuffs by next fall. But that will be only a drop in the bucket.

The NEWS suggests that the back-yard or the front-yard gardening campaign is a mighty efficient way of doing your bit. More than one young chap has been heard to say around the NEWS office that there was going to be less tennis, baseball and golf in his life this summer and more digging and hoeing.

The newspapers and magazines these days are full of hints to garden-makers; but that all of the employees might have a digest of the best information available, the NEWS reprints here a *Garden Primer* prepared for the Committee on Food Supply appointed by Mayor Mitchel of New York City, through whose courtesy it is made available to us.

First of all, clear the ground of all rubbish, sticks, stones, bottles, etc. Choose the sunniest spot in the yard for your garden. Dig up the soil to a depth of 6 to 10 inches using a spade or spading fork. Break up all the lumps with the spade or fork.

After your garden has been well dug it must be fertilized before any planting is done. In order to produce large and well-grown crops it is necessary to fertilize before each planting. Very good prepared fertilizers can be bought at seed stores, but horse or cow manure is much better, as it lightens the soil in addition to supplying plant food. The next best fertilizer is sheep manure—pulverized—which is sold in seed stores for about \$2.25 for a 100-lb. bag. The manure should be well dug into the ground, at least to the full depth of the top soil. The ground should then be thoroughly raked, as seeds must be sown in soil which has been finely pulverized.

Lay out the garden, keeping the rows straight with a line. The next step is the opening of the furrow. (A furrow is a shallow trench.) This is done with the hoe. After the furrow is opened, it is necessary that the seed be sown and immediately covered before the soil has dried. In covering the seeds the soil must be firmly pressed down. This is important.

In buying seed it is best to go to, or to order by mail from some well-established seed house, rather than to take a chance on seeds distributed in stores. With most kinds of seeds a packet is sufficient for a row 30 feet long.

Begin to break up the hard surface of the soil between the plants soon after they appear, using a small stick, hoe or hand cultivator, and keep it loose throughout the season. This is called cultivation; it kills weeds; it lets in air to the plant roots and keeps the moisture in the ground. By constantly stirring the top soil after your plants appear, the necessity of watering can be largely avoided except in very dry weather. An occasional soaking of the soil is better than frequent sprinkling. Water your garden either very early in the morning or after sundown. It is better not to water when the sun is shining hot.

Never handle beans when they are wet from dew or rain; rust may follow and ruin the plants.

If insects or diseases appear, it is advisable to inquire of your seed store as to the proper remedy to use.

The dates given for planting will not suit all localities. The kind of season we have would also change the date of planting. In raising vegetables, as in everything else, one should use one's common (or garden) sense. A good rule to follow is to wait until the ground has warmed up a bit. Never try to work in soil that is wet enough to be sticky, or muddy; wait until it has dried enough to crumble readily.

Directions for Planting

Spinach can be planted like radishes just as soon as the ground can be prepared in the spring. The young plants should be thinned to about 1½ to 2 inches apart. An ounce of seed will plant 100 feet. Spinach is difficult to grow in summer, and Swiss Chard, which is really a leaf beet, may well take its place at that season. In gathering spinach the entire plant is removed, the largest plants being taken first.

Corn should be planted about the middle of May in a place where it will not shade the other crops and can be grown in rows or hills, with extra quantity of manure in the bottom of each hill. Have rows 3 feet apart and thin to single stalk every 14 inches. Hills should be 3 feet each way, 6 or 8 grains to a hill; cover with 1 inch of soil, and thin to 4 stalks when 8 inches high. Plant about every two weeks, using early varieties for the first three plantings and the last planting. One-half pint of seed will plant 100 feet. If "smut," a black fungus, appears break off the affected part and burn.

Peas—Plant peas very early; varieties like Alaska will stand heavy frosts. Do not fertilize just before planting or you will have more vines than peas. For early use plant 1 or 2 inches deep. For later use plant in a trench 6 inches deep and cover not more than 2 inches. After the plants have grown to 4 or 5 inches the soil should be worked in around them until the trench is filled. Rows should be 2 to 3 feet apart. One-half pint of seed plants 25 feet.

Beans—Plant when all danger of frost is past and repeat about every three weeks. Sow in rows 2 feet apart, having seed 2 or 3 inches apart and 2 inches deep. Pick when half grown, to get tender beans; always pick thoroughly, so the bushes will bear longer. This rule applies to all beans, whether string or shell. One pint of beans will plant 25 feet.

Lettuce—The seed of all lettuce should be sown every two weeks in a box and transplanted to rows, or sown in rows and thinned. It heads better if transplanted. Plant in rows 12 inches apart and keep plants 6 inches apart. The Cos or Romaine makes a good hot weather lettuce. When plants are 8 inches high, the leaves should be tied together with raffia or strips of cloth so as to head the inner leaves and make them tender. The outer leaves of lettuce can be cooked as spinach; they make excellent greens.

Beets—Sow seed as early as possible 1 inch deep in rows 12 to 18 inches apart, and when plants are well up thin to 3 inches apart. A half ounce of seed will sow 50 feet. For succession of young beets during summer, plant once a month until June 15. For winter keeping, sow seed in July; harvest before hard frost and store in cellar or pit, removing tops before storing. The young plants removed in thinning can be cooked as spinach, for they, and all beet tops, make delicious greens.

Tomatoes—Set plants, when weather is settled, 3 feet apart each way. Tomatoes can be grown on a trellis or tied to strong stakes 6 feet high. When latter method is used the side branches are removed and some of the foliage trimmed to allow the fruit to ripen. Be careful not to pick off any flower buds. In late fall pick the green fruit and place it in a sunny protected spot to ripen. Buy early and late varieties. Twelve plants will supply a family of six.

Potatoes require much space, but can be planted after early peas, using wood ashes and sheep manure for fertilizers. The furrows should be 6 inches deep and 3 feet apart. Cut potatoes in large pieces with two eyes, so each plant can get nourishment while making root growth. Drop pieces every 15 inches and cover with 4 inches of soil. Look out for bugs, and when they appear spray with Paris green mixed with water.

UNIV. OF MINNESOTA
LIBRARY
COL. OF ENGINEERING

Western Electric News

Vol. VI. No.4 June, 1917



E.T. FELLNER

• One Means of Relieving Freight Congestion •

Protection

For
Night
Drilling

with
Western Electric
Davis
Flood Lamps

For
Industrial
Plants



For Inside Use or
for Mounting on
House Tops.

These lamps furnish ideal illumination for night drilling, for illumination of industrial plants, docks, athletic fields, playgrounds, public buildings, beaches, pageants, etc. They are easily installed, are waterproof, and can be connected to any lighting circuit.

The light is furnished by a 1000-watt Western Electric Sunbeam Mazda Lamp. It is pure white and so diffused that there is neither glare nor shadow. One of these lamps placed 60 feet above ground will illuminate an area of 100,000 square feet.

Write to our nearest house for Booklet No. 521-BJ, giving complete details.

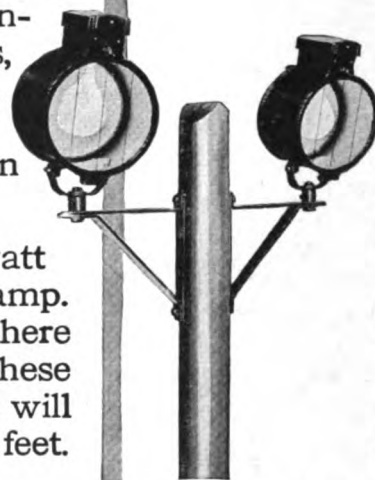

Bracket Type for
Mounting on Poles.

WESTERN ELECTRIC COMPANY

INCORPORATED

New York
Buffalo
Newark
Philadelphia
Boston

Atlanta
Richmond
Savannah
New Orleans
Birmingham

Pittsburgh
Cleveland
Milwaukee
Detroit

Chicago
Indianapolis
St. Paul
Minneapolis

Kansas City
St. Louis
Cincinnati
Dallas

Denver
Salt Lake City
Omaha
Oklahoma City
Houston

San Francisco
Oakland
Los Angeles
Seattle
Portland

EQUIPMENT FOR EVERY ELECTRICAL NEED

An Advertisement Appearing in Current Issues of *World's Work*, *Review of Reviews*, *Red Cross Magazine*, *System*, *Independent* and *Outlook*

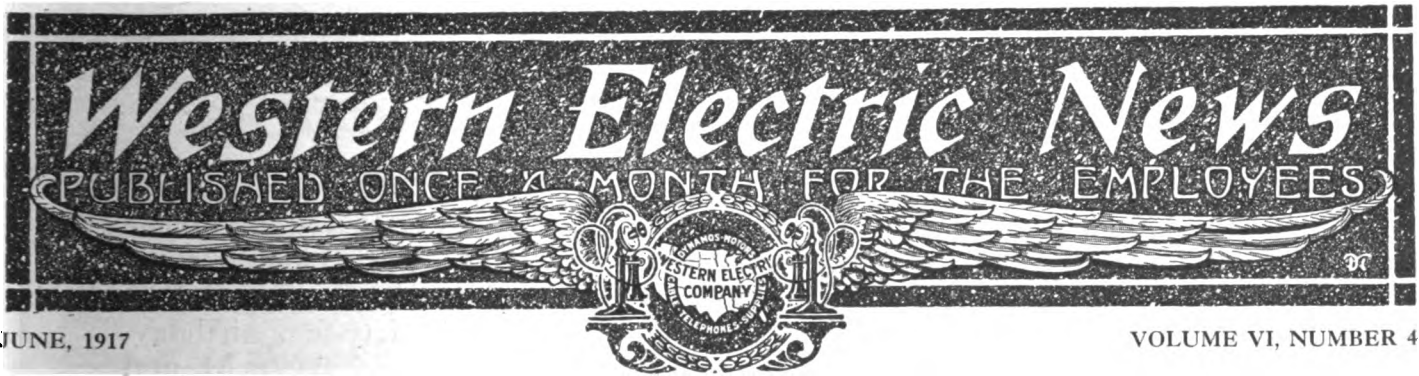

JUNE, 1917

VOLUME VI, NUMBER 4

The Liberty Loan

MR. VAIL has issued the following memorandum addressed to the employees of The Bell System:

"As announced in the press, the United States Government is receiving subscriptions for *Two Billion Dollars* of Government Bonds to be known as the 'Liberty Loan.'

"This is the largest piece of financing ever undertaken in this country, and to be successful it must be subscribed for generally by individuals and corporations all over the country.

"The interest rate is $3\frac{1}{2}\%$ per annum. Denominations are as low as \$50. Applications must be filed on or before June 15, 1917. It is understood that payments of 2% must be made with application and partial payments thereafter as follows: 18% June 28, 20% July 30, 30% August 15, and the balance—30%—August 30; or payment in full may be made earlier.

"The Bell System Companies have subscribed for \$5,000,000 of these bonds.

"In addition to this we assume that employees of the System will desire to participate, whether in large or small measure, in this patriotic undertaking.

"Doubtless many employees will subscribe through banks, post-offices and other agencies of the Government, but any who prefer may communicate with the Treasurer of the Company, who will assist them with full information and advice."

The Western Electric Company, Inc., is joined with the Operating Telephone Companies of The Bell System in the subscription of \$5,000,000, to which Mr. Vail refers. The Treasurer's Department will be glad to be of assistance to such employees as may desire to make use of its services in the purchase of these bonds.

Any employee who may desire to apply a part of his pay to the purchase of these bonds may arrange with the Treasurer through his department head for the delivery to him of bonds in any multiple of \$50 in lieu of cash at the current rates with interest adjustments.

A handwritten signature in dark ink, appearing to read 'W. Vail', is written over the word 'President'.

May 25, 1917.

President.

[EDITORIAL NOTE—Details of the employees' purchase plan will be found on page 24.]

Registration Day

Under authority of Congress, the President of the United States, under date of May 18, 1917, has made proclamation calling all male persons between the ages of 21 and 30, both inclusive; i. e., those who shall have attained their twenty-first birthday and shall not have attained their thirty-first birthday, to present themselves on the fifth day of June, 1917, between 7:00 A. M. and 9:00 P. M. for registration.

Employees of this Company subject to this call will be excused from duty for such period as may be reasonably necessary on that day for the purpose of this registration.



May 22, 1917.

President.

Former Western Electric Doctor and Nurses Called to France

DR. R. V. GRACE, until recently physician at 463 West Street, and Jane I. Rignel and Madeline Evans, who many Western Electric people in New York know as the nurses at "463," sailed recently on the steamer *St. Louis* for Red Cross work in France. All are connected with Presbyterian Base Hospital Unit No. 2, of

the American National Red Cross which, together with other Red Cross units, has been called for service with our Allies abroad. By the time this issue of the *News* is distributed, Dr. Grace and his former assistants will be reporting to the Surgeon-General of the British Army at London. Dr. Grace is now of the rank of Lieutenant, U. S. A.



From Left to Right—Miss Rignell, Lieut. Grace, Miss Evans, and Below, the "St. Louis," Upon Which They Sailed

Seeing That It Gets There

What There Is in Life for the Traffic Department

IF the Western Electric Company should die and go to Heaven, and the various departments stand grouped in wonder before the floodlighted pearly gates which stand at the top of the Sunbeam-Mazda illuminated golden stairs, gazing out upon those vacuum-swept streets all paved with gold, whereon stands mahogany reel after mahogany reel of radi-um-covered cable—through fleecy



Copyright, Underwood & Underwood.

The Lighterage Involved in Traffic Movements Through Our Big Cities is Enormous in Quantity. Taken Near Brooklyn Bridge

clouds electrically washed and a Milky Way pressed smooth by the even bosom of a No. 1 iron, they might behold St. Peter taking down his interphone to ascertain who was at the gate. The engineering department, with a frank smile of relief on its face, might press eagerly forward; General Sales, we dare say, might be scanning the subsidiary angels of the outer hinges for prospects; and the manufacturing folk, perhaps, might be searching the ether for a large flat nimbus whereon to start a second Hawthorne—but elbowing all these aside, and striding up to the very topmost stair, would come another department with quick, energetic step and address the reverend door-keeper in something like the following urgent words:

“Do the trains here always run on time? Are your tariffs on file with the Interstate Commerce Commission? Is it true that in the bright lexicon of Heaven there are no such words as “embargoes” and “freight congestion”? And *are* the cerulean insurance rates really only $\frac{1}{8}$ of 1%? And do we correctly understand that cargo space to Mars is *never* at a premium? . . . 'Cause if all these things aren't true, we're not sure this is Heaven!”

And that—it is celestially and terrestrially certain—would be the traffic department!

Now descend, if you will, from this rarified atmosphere and resume your position on earth with both eyes upon the method of handling the traffic of the Western Electric Company's great annual output of goods. Observe the organization which looks after it all. As General Traffic Manager, Vice-President Salt; as Traffic Managers at New York and Chicago, respectively, Messrs. DeWitt and McDonnell; and in charge of our foreign shipping, Mr. Tulloch, of the Foreign Department, are responsible for the

expeditious and most economical movements from place to place of nearly one million tons of Western Electric freight each year, to say nothing of a few million pounds of stuff that travels by express and parcel post. The freight shipments naturally far outweigh all others, but a considerable lot of material, particularly small orders, is handled that way. During normal times this is usually confined

to such small shipments as offer a saving—during these abnormal times, and when emergencies require it, full carloads are often moved by express. Millions of pounds are moved each year to and from our distributing houses and suppliers. When you consider that on this earth trains do not always run on time, and that there are such words as “embargoes,” “freight congestion,” “differential rates,” “overloaded wharves,” “irregular sailing schedules,” and that war insurance rates on foreign shipments have been recently jumping as high as 20%, and moreover that cargo space to all parts of the world is not only extravagantly expensive but extremely scarce, then you will believe that the job of “Seeing that it gets there quickly, and at the cheapest rate,” is a real big one—in fact, you might say that it was an emergency job 98% of the time.

The function of the Traffic Department is first, to route Western Electric goods by the quickest and at the same time most economical route. Then, to keep these goods moving speedily, and, lastly, and by no means of least importance, to be aware of the whereabouts of the goods in transit so that they can lay hands upon them and rush them to any part of the country upon short notice.

The Railroad Tariffs

The first work of the Traffic Department is that of routing shipments from the hundreds of points of supply to distributing houses and direct to customers, and from distributing houses to customers. This work is complicated by the fact that railroad rates in this country are about as simple as a Chinese puzzle. For instance, there are filed each year with the Interstate Commerce Commission, by the hundreds of railroads in the country, approximate-

ly 140,000 different tariffs, containing freight rates and rules and regulations, ranging in size from one to sixteen hundred pages each. The law permits these to be changed by supplement upon thirty days' notice, so that there is an endless chain of revisions which the Traffic Department is supposed to keep posted on. It is often necessary for the rate man to consult eight to fifteen different tariffs to obtain one rate, so don't feel neglected when you call the Traffic Department, and do not get your rate off-hand. There are long rows of tariff cabinets in the New York Traffic Department which contain most of the important tariffs affecting the Company's business, but even this limited quantity is staggering to the layman. These tariffs are important, because on the knowledge of them depends the efficiency of routing and obtaining reasonable freight rates on our goods.

In addition, the Traffic Department must keep posted on the traffic laws of the various State Commissions as well as those enforced by the Federal Government, in order to avoid legal complications and controversies with these bodies.

Suppliers' Contracts

They must also keep informed of the conditions in the purchasing contracts with suppliers, so as to take full advantage of such terms when giving routing instructions. For instance, the rate on insulated tape from Chicago or the East to San Francisco is \$2.20 per one hundred pounds less carload. From a rate view alone they would ship this tape from Chicago in the Hawthorne-Frisco car at a carload rate of 1.60 per one hundred pounds. But a contract with supplier allows freight of .799 per one hundred pounds from the East, not allowed from Chicago, therefore it can be shipped through from the East at 2.20 less .799=1.401, and at the same time avoid handling through the Hawthorne Shipping Department.

Rates via rail and water routes are usually cheaper than

via all rail, although the service is considerably faster in some cases. Routes selected by the Traffic Department are based on requirements of distributing houses, the customer, or our Hawthorne plant, at the time order is placed. Material for Hawthorne is usually routed direct all rail, while other shipments move via the cheaper or "differential routes."

It Pays to Consolidate

The Traffic Department keeps the distributing houses posted on traffic matters and rates they are interested in. It will probably be interesting to a good many to know that you cannot hire a freight car from a railroad, but that all carload rates are based on a minimum carload weight. These vary from 8,000 lbs. on bulky articles to 100,000 lbs. on coal. Besides, the minimum carload weight differs in various parts of the country. For instance, in the State of Illinois 24,000 lbs. of iron wire is equivalent to a carload; in the South and local in Texas, 30,000 lbs. is necessary; in the East and West, 36,000 lbs., whereas from any of our suppliers to the Pacific Coast 80,000 lbs. is needed.

The savings effected by the calculations of the Traffic Department simply by consolidating the shipments going to Texas points in the year 1916 amounted to \$8,545. In other words, if every shipment to a Texas point had gone through all rail without receiving a special routing by the Traffic Department, and if the carload minimum had not been considered, our freight bill for the carriage of these goods would have cost us that much more. The total savings effected by using water and rail instead of all-rail routings, and by consolidating shipments, was over \$100,000 for the year 1916.

The Traffic Department receives copies of all orders placed covering material weighing 3,000 lbs. or over, and it is from the information shown thereon that they decide on routings, arrange for consolidations or call attention to



the house issuing it of a saving in freight by some change in quantity of material ordered. Orders of less than 3,000 lbs. move on standardized instructions filed with suppliers. Recently it has become necessary, because of the unusually congested condition of transportation, to pitch in and help the concerns who sell us raw materials, in an effort to get copper, paper, wood, lumber, etc., to our suppliers, who convert these things into such form as the Western Electric Company requires. In all such cases quite naturally the Traffic Departments, both East and West, work in close co-operation with the Service Departments, and with the General Purchasing and General Merchandising Departments.

Sometimes Carloads by Express

The great bulk of Western Electric freight comes from our suppliers. Poles, line hardware, copper and iron wire, motors, conduits and electrical equipment of all kinds are continually flowing in great streams from our factory, or suppliers, to our customers throughout the world, either direct or through our distributing houses. All sorts of emergencies arise which demand quick action and special unusual instructions. A Western distributing house may be setting up an awful holler for a car of hardware that is coming on from the East and has been lost temporarily in the traffic jams that clog the railroad gateways of some of our large cities. It becomes absolutely necessary, the Traffic Department learns, to get hold of that car and arrange for special service or possibly re-forward its contents by express. It may cost as much again as the stuff is worth to get it there on time, but the unusual conditions—the fault of nobody—demand it.

Our Traffic Department to meet this situation works through the traffic and operating departments of the railroad over which the shipment is routed and, finally, after making the wires burn for a few hours, locates the car, perhaps, in a railroad storage yard, or on a side track in some suburb—long overdue. If necessary immediately arrangements with an express company to transfer the contents of the freight car to an express car which travels with a right-of-way equal to that of passengers themselves. Hurry! Rush! Hurry things up!—that is the slogan of the Traffic Department.

Indeed, it is not an unknown thing for the traffic people



This is What the Traffic People Mean by Freight Congestion. Goods Piled Up On a New York Wharf Awaiting Steamer to Carry Them Abroad



The "Ruth Stark" Which We Chartered

when they simply *have* to get a certain car into a certain city at a certain time, to bid the railroad company pluck out that car from a traffic jam by crane. You could not say that this was a frequent happening in Western Electric traffic circles, but it is certainly not an unusual one. The railroads are prepared for just such emergencies, and when the desired car is finally spotted, it shoots the crane car down on an adjoining switch and lifts the desired car clean to a free track where possibly a special engine, which our company has hired, is waiting to drag it quickly off toward destination. The whole situation, of course, is frequently aggravated by storms which not only delay freight movements, but increase fourfold the urgency of the demand on the part of some telephone company or distributing house which wants extra wire at that particular time on account of damage by the same storm.

Nearly a million tons of freight, we said, moves for the Western Electric Company every year. To be exact and a whole lot more impressive, it is one billion, eight hundred million odd pounds. We seldom have a whole train load of freight, although a very large consignment of lead-covered cable from Hawthorne bound overseas was shipped out last fall, but we do have a great many carload lots. The aggregate weight of carload-lot shipments far exceeds the L. C. L., or less than carload-lot shipments. Our goods do not always move by a railroad, of course, even within the United States. Cargo ships on the Great Lakes, coastwise vessels and barges upon some of the canals play their part in carrying Western Electric goods. Nor are the interurban trolley and the auto truck slighted. Frequently, in case of emergency, the trucks of the telephone companies help expedite movements into the big cities from nearby freight points.

Getting the Stuff Out of the Country

When it comes to getting the stuff out of the country an entirely new set of problems arises for a solution, and the traffic branch of the Foreign Department has to worry not only about many of the problems of railroad congestion, but about cargo space, submarines, mines, sky-rocketing insurance rates and contraband restrictions.

The Foreign Department traffic supervision begins where the Domestic Traffic Department leaves off—generally speaking, at the wharves. Even in normal times it

is an intricate task, for our shipments go to the ends of the world—Iceland, New Zealand, South Africa, India and Argentina, for instance—but in the last few years Mr. Mars has stepped in and complicated matters with a capital “C” so that often foreign traffic work does not begin simply at the wharf.

The railroads learning their lesson from freight congestion have been obliged to refuse to haul outbound shipments to the wharves at the seaport unless they have formal assurance that there will be a steamer available to carry them away. Western Electric folks at 453 West Street know what it is to look out upon pier after pier stacked high with freight. It is for just such reasons that the railroads have come to demand steamship permits guaranteeing removal of the goods, before they will carry them from an inland port to the coast.

The Contraband Shipping Conditions

Booking freight, taking out insurance and arranging shipping papers are all traffic jobs of the Foreign Department. But before these things, of late, there has been the necessity of complying with the contraband shipping conditions of the countries which are now our allies in the Great War. No steamship company would agree to carry a shipment to neutrals in Europe which had not been approved by the British War Trade Bureau in London or Washington, D. C.—an organization whose function it is to prevent the needless shipping abroad of materials which would be liable to seizure by the Allied Naval Patrol on the grounds of their being of use to the enemy, had these materials found their way into the countries of the Central Powers. Like all other concerns shipping abroad, therefore, the Western Electric Company through its Foreign Department, has shipped with great care, and has reported the make-up of all cargoes consigned to neutral countries in Europe to the British War Trade Bureau. Any shipment, for instance, which contained more than 10% of that precious metal, copper, has been a poor thing to try to make foreign delivery on, even to neutral countries.

Cargo space in vessels has, of course, been at a great



THE “RUTH STARK” IN PORT

Taken Just Before She Sailed. In the Background Observe the Ill-Fated “Chemung,” which Was Sunk by a Submarine on Its Next Voyage to Genoa

premium now for nearly three years. Sometimes it has been impossible even to get space to certain ports at any price whatever. In such a case, not long ago, the Foreign Department had to rise quickly to an emergency and lay hands upon a sailing vessel. Sailing vessels are perfectly good carriers, but your modern exporter would turn up his nose at anything short of a steamer in normal times. In war-time, however, even though sailing vessels are slow, they are sometimes very welcome. This particular shipment was a large and urgent one—twelve carloads of clay conduit and several hundred poles—and to carry it the iron bark *Ruth Stark* was chartered in conjunction with another large shipper. The temporary Western Electric ship, which was one of those scarce vessels flying the American flag, made the journey in sixty-five days, and the Foreign Department considered itself very lucky to meet the unusual traffic conditions in this way, even though the time which a steamer usually takes is only twenty-five days.

So now you have an inkling as to the Traffic Department’s motives in asking St. Peter all those questions.



Results of New Customers and New Business Contest for March, 1917



A. B. Spicer

THE salesman securing the largest number of new customers during March was:

F. O. Lightfoot, Chicago.

The salesmen securing the highest number of points or sales to new customers for the period ending March 31st were:

A. B. Spicer, St. Louis, 239 points.

A. B. Vandercook, Los Angeles, 188 points.

J. E. Lowrey, Dallas, 187 points.

Change in Organization

A. M. COLLINS has been appointed Sales Manager at Detroit. The change became effective on May 14th.

A. M. Collins who, on the 22nd of this month, will celebrate his eleventh anniversary with the Company, began his Western Electric career in the Telephone Engineering Department, Equipment Division, in 1906. Two years later he was transferred to Indianapolis as Telephone Apparatus Salesman, and later became Sales Manager at that place. In 1914 Mr. Collins was moved to the Chicago House where he took up work as Telephone Sales Specialist. Since 1916 he has been handling supply quotations at Chicago.

Mr. Dooley on Who's Hurt and How

(Mr. Dooley Borrowed from F. P. Dunne; Statistics Borrowed from Various Government, State and Insurance Company Publications)

MR. HENNESSY leaned over to read the title on the pamphlet lying across Mr. Dooley's knee. "Vittle Statistics," he read. "Sure, an' phwat moight that be, Dooley—anither book on the hoigh cost av livin'?"

"No, no, Hinnessy," answered Mr. Dooley. "Not 'vittle,' man. The oye is long, as in Chinamin, aven if ut aint sit on the bias. 'Vital' ut is, an' ut concerns the low cost av doyin'."

"Sure, thin, ut's got me bate," replied Hennessy. "Foiht all' Oi cud undershtand as good plain Oirish, but when yez throw a V into ut yez knock ut sinseliss intoirely. Phwat moight ut mane?"

"Will," answered Mr. Dooley reflectively, "ut's har-rud to put ut into wor-ruds, but ut's stuf about births an' diths an' sich loike. This here is wan av the books me niphef lift wid me. The b'y has gone into the loife an' accidint insurance business an' he wants me to insure me loife, the scamp, so thot as long as Oi live he kin cash in on the praymium an' thin, afther he's laid me tinderly away, he kin lay me insurance money legal tinderly away, also, the young rapscaillon. But Oi suppose Oi'll have to humor the b'y."

"Thin 'statistics' r'ally manes somethin', does ut?" asked Mr. Hennessy. "Sure, Oi always thought ut wuz a wor-rud made oop be some woife to tist her hoosband's sobriety."

"Oh, yis," replied Mr. Dooley, "'statistics' manes somethin'. They ar-re what you an' me, now, wud call 'figgers,' only ut sames there's a bit av a diff'rince bechune 'em. Jist what ut is Oi don't know, onliss ut's that 'figgers don't loy.' Annyways, statistics will, unliss yez quistion thim moighty close, an' take what wan lot tills ye an' compare ut wid the informashun yez git from anither sit. But if yez use 'em koindly an' woisely they'll till yez a lot, an' they sure do a poile av wor-ruk for the insurance companies."

How This Insurance Business Really Works

"If yez'll think ut over careful, Hinnessy, yez'll say that whin yez insure yer loife what yez r'ally do is this: Yez bit the insurance coompany that yez wun't live long anuff to pay in as mootch as yer widdy'll git be tradin' in yer corpse, an' the coompany bits that yez'll pay in more. Now, yez don't shtay awake noights dayvisin' manes to win thot bit. Yez ar-re perfictly satisfoid to lose. But the insurance coompany ain't. They ain't playin' ut to loose. So they git together their boonches av statistics an' they draw conclusions from the Governmint's statistics an' the raysoolt is thot whin they ar-re done they're bittin' on a sure thing. Not in your case, neissarily, yez moind, but on the average. They've got things so that the average man can't doy a year sooner nor later thin what they till him to, nor he can't git hurted aftener thin they'll allow."

"Hurted?" queried Mr. Hennessy. "Yez don't mane to

till me they insure a man agin injury—ispishally thim thot wor-ruks in facthories, where thousands ar-re killed an' hurted ivery day?"

"Oi mane jist thot," replied Mr. Dooley. "But lit's not go so fast wid our killin' av thim thousands ivery day. Now yez have bin workin' at the mill fer 30 years. How many have yez known to be kilt in thot toime?"

"Will," said Hennessy, "there wuz O'Connor's b'y."

"Sax years ago thot wuz," broke in Mr. Dooley, "an' he wuz kilt boy shtandin' on want fut to loight his poipe while raypairin' the shmoke-stack."

"Yiss, Oi know," said Hennessy, "our mill ain't bin so bad, but luk what happens in most facthories."



"Ivery Machane is So Protected Yez Almost Cudn't Hur-rut Yersilf if Yez Troyed"

"All roight," replied Mr. Dooley, picking up a pamphlet, "lit's luk. Here's an accidint raypoort from the state boord av Massachusetts, a state thot has made iverything from history to shoes, first an' last—the first fer the history' and the lasts fer the shoes. The raypoort siz thot durin' the year indin' June 30, 1915, 95,000 pa-apele wuz hur-rut in industhries. Now, jist a minnut, Hinnessy! Forty-foive thousand av those only had little cuts or scratches an' were able to go back to wor-ruk as soon as they wuz toid oop. Sax hoondred and forty-four lost a

finger or a toe. Only wan lost both oyes, only two lost both fate an' none lost both hands. Thray hoondred an' sivinty doid. How minny av these were loightin' their poipes on top av schmoke-stacks, loike O'Connor's b'y, the raypoort don't state, but loikely they wuz severial. Pa-able will be careliss. Oi raymimber me frind, the plant inspiector av the Wistern Alietric Coompany, tillin' me about visitin' a facthory an' sayin' a wan-oyed man chippin' castings. He didn't have on anny oye-protictin' goggles, sich as he wud have been compilled to wear at the Wistern, an' me frind ast him if his coompany didn't sooply him anny. They did, but he had thim in his pocket. 'Boy the way,' ast me frind, 'how did yez loose yer oye?' 'Chip-in' castings,' sid the man.

How It Goes in Massachusetts

"So there yez have it, Hinnessy. Ayther boy their own fault or widout ut thray hoondred an' sivinty pa-able wuz kilt in industhries in Massachusetts, an' durin' the same toime joost thray hoondred an' sivinty-four pa-able doid av thim two 'harmless' disayses, whoopin' caff an' measles. An' most av those wuz little childer, Hinnessy, thot didn't troy to mate the oondertaker half way be loightin' their poipes whoile shtandin' on wan fut at the top av a shmoke-stack. So, ye say, a couple av harmless disayses has got the facthories bate boy four diths, at that.

"But howld on, here, Hinnessy. Ut's wrong Oi am. They got the facthories bate boy *two hoondred an' sivinty-noine*, fer Oi foind here thot only nointy-foive av thim thray hoondred an' sivinty fatal accidints was in facthories. The ither two hoondred an' sivinty-foive wuz kilt in strate an' buildin' wor-ruk, on railroads an' in ither wor-ruk outside av facthories. An' Oi foind here thot ordinary pea-neumonia kilt 30 toimes as manny pa-able as all manufacturin' plants together.

"An' here's somethin' fer yez, Hinnessy. Durin' this same period 294 persons in Massachusetts thought they hear-rd an auto horn an' woke oop to find it was Gabriel's trumpet. Yiss, sore; more thin thray toimes as miny pa-able was flivered into the Great Beyant than was kilt in all the facthories in Massachusetts, where there is a total av 600,000 facthory workers. Liss than wan in 6,000 av thim was kilt at wor-ruk.

Not a Bit Like Farming

"Will," admitted Mr. Hennessy reluctantly, "thot don't sound so bad. But ut ain't loike farmin'."

"No," assented Mr. Dooley. "Ut ain't loike farmin'. Takin' the counthry over, wan farmer out av ivery twinty-noine hoondred is kilt ivery year, whoile in manufacturin' only wan out av ivery *four thousand* is kilt. So don't go to the farm for safety-first, Hinnessy. Go to the facthories an' yez'll be safer. An' go to the careful facthories an' yez'll be safer yit. Some toime Oi'll take yez fer a thrip through the Wistern's plant at Hawthorne, Hinnessy. Whoy, ivery machine that kin be guarded is so protictied yez almost cudn't hur-rut yersilf if yez troyed. Oi don't belave a babby cud aven cut ut's tathe on wan av thim. But on the farm ut's diff'rint. Sure, if cows is still vige-tarians ut's only becuz they rayfused to lit their tastes be

corrupted boy the stubs av farmers' b'ys' fingers fed to thim wid the fodder cut oop fer thim in the hay chopper whin they wuz calves. Ut's far aisier, Hinnessy, to scowld yer kids fer carelissniss thin ut is to put guar-rds on yer machanery. On the farm yez git the scoldin's, in the facthories yez git the guar-rds. An' both places yez git the carelissniss. Here's a careful ricord kept for a noomber av years boy a big public service corpora-ashun an' ut shows thot fifty-sivin per cint av all accidints wuz dirictly caused boy carelissness on the part av the person hur-rut, and elivin more per cint wuz due to fellow employees' carelissniss—more thin two-thirds av thim in all.

"Yez'll probably be sorproised to learn the cause av most av the hur-ruts, Hinnessy. Yes have hear-rd av the foorce av gravity, Oi suppose?"

"Yiss," answered Mr. Hennessy, "Oi hove, but thot sort av a bluff don't go down wid me. No man kin foorce me into doin' somethin' boy lukin' loike an oondertaker. Give me the boss that shmoiles wanst in awhoile."



"He is Sint at Wanst to a Modern, Foine an' Illigent Hospital" (A Minor Injury Dressing Room of the Hawthorne Works Hospital)

"No, no, man, ye're wrong again," exclaimed Mr. Dooley. "The foorce av gravity is the pull somewheres down in the ground that makes things fall. Ut wuz dishcovered boy Sir Isaac Newton about the year sixteen hoondred an' sivinty—too late to git a patent, as things hod bin fallin' iver since Moother Ave fill fer the sarpint's blarney in the Garden av Edin. Now this same old foorce av gravity—(pa-able fallin' theirsilves or bein' hit boy somethin' fallin')—was raysponsible fer 15,000 av the 82,000 fatal accidints in the whole counthry in a year. Stame railways only got 13,000, an' autos, strate cars an' ither vehicles came nixt wid a bit over 9,000. Anither 9,000 wuz kilt be drowndin'. Av coorse, thot didn't include anny of the floatin' popylashun, as most av thim niver touch watter internally a-tall, a-tall, an' aven liss often ixternally. Sivin thousand sivin hoondred pa-able doid from burns; 3,800 wuz kilt in mines and twinty-sivin hoondred cashed in becuz the wither man wuz intoirely too liberal wid his sum-

mer temperature. Eighth on the list av causes av dith is machanery, wid 2,230. An' thot's all sorts av machanery in all sorts av ba-ad loighted dangerous places—garages, small machane shops, barns, et cettry. Will-loighted, will-guarded machanes in oop-to-date facthories hurt moighty few.

"Thim Raymarkable Hospitals"

"Whoy, the bitter facthories nowdays don't stop wid gua-ardin' their machanes an' supployin' foine, loight, elane workin' places wid the bist av toilit facilities an' numerous sanitary dhrinkin' fountains av cooled an' filthered wa-ather. These days they aven protiet a man agin his own carelissniss. Suppose he cuts his finger. He wants to wrap ut oop in a rag tore off'n his han'kerchiff an' fergit ut—that is, ontill blood-poisonin' sits in. Do they lit him? They do not! He is sint at wanst to a modern foine an' illigint hospital, where he resaves the very bist av careful attintion. Moreover, he must rayport at the hospital ivery day thereaftherwards ontill the cut is intoirely healed oop. The coompanies loose toime in mebbe elivin cases out av twilve, where nuthin' wud happen from niglictin' the cut, but they save toime on the twilfth man—an' mebbe save his loife into the bargain. Whoy, the Oh-hio raypoorts show that wan-tinth av their serious injuries amounted to nuthin' ontill thim spalpeens av microbes got in their wor-ruk. As ut wuz, 30 diths occurred from the koind av hur-ruts you an' me pay no attintion to. But, as Oi've jist been after tillin' yez, Hinnessy, they don't allow sich things in the bist facthories. Av coorse, the only wan Oi know annything about from personal observa-ashun is the Wistern's plant at Hawthorne, but Oi oonderstand thot ither progrissive plants around the counthry ar-re workin' along the same loines."

"Ut sames to me," remarked Mr. Hennessy, "thot they make altogether too mootch fuss over microbes these days. They wuzn't no sich things whin Oi wuz a b'y. Oi've cut meself hoondreds av toimes an' Oi ain't niver yit disrespected the hur-rut wid pure ox hide, er whatever yez call ut. An' Oi ain't niver doid from wan yit."

"Mebbe not, Hinnessy, mebbe not," answered Mr. Dooley. "Oi noticed be the pa-apers thot a man rockin' a boat wuz drowned fer the fir-rust toime yisterday. He hod rocked boats lots av toimes befur, so he knew ut wuzn't dangerous."

Mr. Hennessy hastened to change the subject. "Av coorse," he remarked, "min is moighty loikely to git hurted wid their rough play an' ginerall ricklissniss an' prob'ly they ar-re jist as safe or safer at wor-ruk thin ilsewhere. But the gir-ruls now. They oughtn't to wor-ruk in facthories an' take all thim ixtry risks."

"Will, now," answered Mr. Dooley, "wan av the Unoitid Sta-ates raypoorts here has somethin' to say on thot subject, too, but Oi raygrit to say thot Uncle Sam is rude anuff to conthradict yez, Hinnessy. He goes roight afther the fact in manufacturin', an' his figgers show thot, considerin' the same noomber av aitch six in facthories, tin min is hur-rut to ivery wan woman, but takin' aqual noombers agin outside av the wor-ruk shops, wan woman is hur-rut to ivery thray min. So on the average a gir-rul is over thray toimes as safe in a facthory as anywheres ilse."

"Will, now," remarked Mr. Hennessy, "thot sure is

funny. Oi always thought from what Oi've rid in the newspa-apers thot facthories wuz turrible dangerous places."

"Thot's only natural, Hinnessy," replied Mr. Dooley, "becaz most av the serious accidints in facthories happen

Fatal Accidents Per Thousand Men Engaged in Various Industries

(Estimated for 1913 by F. L. Hoffman from all available statistics. See bulletin of U. S. Bureau of Labor Statistics, issued March, 1915, under the title "Industrial Accident Statistics")

Occupation	Fatal Accidents per thousand workers
Metal mining	4.00
Coal mining	3.50
Fisheries	3.00
Navigation	3.00
Railroad employees	2.40
Electric light and power.....	2.25
Navy and Marine Corps.....	1.85
Quarrying	1.70
Lumber industry	1.50
U. S. Army.....	1.49
Building and construction.....	1.25
Draymen, teamsters, etc.....	1.00
Street railway employees.....	1.00
Watchmen, policemen, firemen.....	.75
Telephone and telegraph employees (including linemen)50
Agriculture (including forestry and animal husbandry)35
Manufacturing (general)25
All other occupied males.....	.75

"Don't Go to the Farms Fer Safety-First, Hinnessy. Go to the Facthories An' Yez'll Be Safer"

in some old foire-trap av a place, where mebbe a hoondred or more employees ar-re hur-rut be a floor cavin' in or as the raysoolt av a bad foire. But the bitter shops don't have foires an' cave-ins. Aven if there wuz no danger to their pa-ape, they cudn't afford the loss in prodooction. Whoy, out at Hawthorne ut's almost ridiculous the pray-cautions they do take agin foires. In the fir-rust place all the buildin's ar-re brick, deyvoided into sictions be brick foire walls fitted wid hivvy stale foire-doors. Thin there is an automatic sprinkler system thot wud put a damper on anny foire, noight or day, at the same toime ringin' oop the foire daypartmint. Oh, yiss. They've got a foine trained foire daypartmint. Not only thot, but they've got an auxiliary sit av foiremin among the workers. Also they hove foire drills in diff'rint daypartmints av the shops, which ar-re called at irrig'lar toimes, so thot if iver a rale emergincy shud aroise, they cud impty the daypartmint widout gittin' scared an' causin' a panic."

"Will, will, will," exclaimed Mr. Hennessy, "thot's all news to me! Oi always thought thot facthories wuz the fir-rust loine av tranches, so to spake, av the industrhal ar-rmy. But it sames, thin, thot a man ain't kilt very often in the facthories afther all."

"Roight fer yez, Hinnessy," answered Mr. Dooley. "Sil-dom indade is annybody kilt aftener thin wanst."

Swinging Around That Circuit

Part II: Sidelights on Our Houses in the Rockies

“ALL aboard train No. 8, for the West—for Buffalo, Cleveland, and Detroit,” calls out the man in uniform at the Grand Central station in New York; but after you have traveled around our distributing houses west of the Mississippi, you have to be careful not to refer to any of our offices in Ohio or Michigan as any more “western” than is little old New York itself.

Indeed, almost every section of the country seems to be jealous of that designation “western.” Your Boston man, of course, and your Philadelphian have little use for mere geography as a claim to civic distinction, and your New Yorker, with his Wall Street and his Broadway, is quite ready to believe that the sun rises in Long Island Sound and sets just back of the chimneys of Hoboken. But after you leave the Atlantic coast you will find that the natives have some conception of distance, of their home town's elevation above sea level, of the State's rank in the production of grain, of the number of railroads that traverse it, its rate of increase in population, etc.

The Western Electric boys of the middle and far West share these native characteristics, and good-naturedly excuse many things emanating from the East, because they are well convinced that New Yorkers are the most provincial people in the country.

The traveler among these houses in the “real west” is sure to find a warm welcome. The local men—loyal to their city, their State, their mountains, and their institutions—have genuine pride in showing their guests all these things of interest. Automobiles are always available, and many a delightful ride is afforded the visitor.

A Mile Above Sea Level

Denver, the “mile-high” city, will impress you for its clear, dry atmosphere, its well-paved and well-lighted streets. Curtis Street, upon which our office is located, fairly rivals in its brilliancy Broadway in New York and State Street in Chicago. Hundreds of thousands of Mazda lamps are to be found on the electric signs and building fronts there, concentrating in the motion-picture district, which corresponds to the theatre districts of eastern cities. In Denver, even the churches have their electric signs.

A never-to-be-forgotten automobile drive out of Denver was one up Lookout Mountain, at the edge of the Rockies, twenty-five miles away, in company with Manager Alexander Brown, of our office, and J. A. Greenawalt, Publicity Manager of the Mountain States Telephone Company. This drive took us up 7,700 feet above sea level to Wildcat Point, where it is proposed that Buffalo Bill be buried and a shaft erected in his honor.

From this elevation the eye can see the plains of Colorado stretching off hundreds of miles to the east with Denver in the foreground twenty-five miles away, and at the base of the slope Golden, Boulder, and other former mining towns, with here and there a straggling smelter no longer in use. For the miners have long since pushed their operations back into the mountains, and the placer mining in the beds of the streams, which have their source up

on the snow-capped heights, are now marked only by the remains of shacks and dismantled machinery along their banks.

Our Denver manager, Alexander Brown, has a bungalow up on one of these mountains where his family summers and he spends his week-ends. It is far enough from the beaten track of automobilists to have made the problem of reaching it in his own car “some job.” But he did it, and his was the first car to climb the mountain.

A Midnight Scare

The boys in the Denver office are telling a good story about their chief. Last fall he tempted fate by prolonging his stay up on the mountain until pretty late in the season. In the middle of the last night that he and his family were there, they were aroused by the sound of an automobile horn. It blew continuously, and it wasn't the most cheerful sound in the world either, up there as they were, all by themselves.

Brown arose, got out his gun, and crossed to the other side of the house. With the aid of his electric lantern he could see his own car, which had been left out alongside of the porch. It was snowing hard and the wind was high. Nobody was visible anywhere near the car, but it was his own horn that was making the racket, and it certainly was in trouble. So Aleck hurried on some clothes and went out to investigate.

The wind had driven the wet snow under the hood or up from the ground under the engine, and there was a thin coating of it reaching across two exposed wires which lay close together. This dampness had caused a short circuit, and the horn had responded with its signal of distress.



Colorado's Famous Cave of the Winds is Lighted by Sunbeam Mazdas

Most of us object to one of these raucous blasts even for a second or two as we cross the street in broad daylight. Brown says that the howl of a coyote or mountain wolf hasn't anything on a Klaxon as midnight music up on a Colorado mountain.

The Company has two places of business in Denver. At the Curtis St. location, referred to above, is the retail store—consisting of the main floor and the basement of a modern brick building with a wide frontage, permitting of two long window displays on either side of the entrance. On this main floor, in addition to the counters and display racks, are located the offices of the manager, sales manager and stores manager, and the others engaged in the cus-

tomary office work. Supply stock is carried in the basement.

Our other place of business is the telephone warehouse and shop, conveniently located to a railroad siding upon which material is received and shipped in carload lots. This building is typical of others of the Company in different parts of the country, selected primarily for their convenience in handling large quantities of materials at minimum cost.

From this centre, with Salt Lake City as a sub-warehouse, is handled our business with the Mountain States Telephone Company. They serve a territory embracing approximately 750,000 square miles and covering seven States and a part of an eighth.

With a territory so vast, and with transportation problems necessarily so acute, the job of serving Denver's customers is a very different one from that of some of our eastern houses with a thickly settled territory. The territory of our New York house, for instance, is 55,000 square miles, or about one-fifteenth the size of Denver's.

The most picturesque route west from Denver lies over the Denver and Rio Grande Railroad through the celebrated Royal Gorge. On the way you will doubtless stop over for part of a day to visit Colorado Springs, and from there drive by automobile in sight of Pike's Peak all the time, to the Garden of the Gods, to Manitou at the base of the mountain, and up to the Cave of the Winds. This natural cavern of more than a mile in length is of special interest to Western Electric people, because it has just been lighted by electricity and Western Electric Sunbeam Mazda lamps. It is easy to believe that they are an improvement over the old-fashioned hand lamps that thousands of tourists have heretofore carried.

Over the Great Divide



Through the Royal Gorge

which in the East would be far above the clouds.

When you start out from Colorado Springs you are more than a mile above sea level, and by nightfall the train has climbed over 4,000 feet more, until at Tennessee Pass you are over 10,000 feet, or close to two miles, above the sea. At this elevation one will find his ears "ringing"

If there is a single day's railroad travel anywhere in the United States that compares with that from Colorado Springs, through the Royal Gorge and on up the eastern slope of the Rocky Mountains to the summit of the Great Divide, then I have yet to find it. Here is one case where the railroad company's literature doesn't overstate the case, nor the picture postcards overcolor the beauty and grandeur of that ride up to elevations

and his head light. Moreover, if you alight at the railroad station, and start to walk, you will soon notice that your heart is pumping along as though you were doing a Marathon.

I'd like to use the NEWS to tell you by written word and show you through the eyes of my camera some of the wonderful things to be seen from the observation car of



At Wildcat Point on Lookout Mountain, Near Denver

that train, but the Editor has already warned that the NEWS isn't running in competition with either a railroad prospectus or the *National Geographic Magazine*—and, besides, this started out to be a story about Western Electric people; so we'll be on our way.

Salt Lake City

A half-mile tunnel through the very summit, and, when we emerge, the tiny stream that trickles alongside the roadbed tells the story. It flows in the direction the train is moving, and we are on the Pacific slope.

We ride all night, coming out of the mountains in the morning, and by the middle of the day reach Salt Lake City. Like other provincial Easterners we find that, instead of the more or less crude "town," here is a flourishing metropolis of the plains, that fairly radiates progressiveness and prosperity. First of all you notice the broad streets, and then you learn that they are, all of them, 132 feet wide. Then you observe that in each of the deep gutters is a fast-flowing current of water, and you are told that this is the city's continuous bath, winter and summer, and its source the overflow from the municipal reservoirs up in the mountains. Then you look around for the typical inhabitant you have been imagining—a long-bearded, long-coat-tailed, religious-looking man followed by a group of twelve or fifteen women, and by that time our Salt Lake manager, Charley Talmage, or somebody else, tells you to "come to" for you're talking about things which do not exist—an old order that has long since changed.

True, the guide in the "rubber-neck wagon" still points tourists to the house where Brigham Young's fifteenth wife lived, and to another where his "favorite wife" lived, but, after all, these are only curiosities. Of real interest though is the famous Mormon Temple, the tabernacle, and the administrative buildings of the present-day Mormon church. The Great Salt Lake, which is six times as salty as the ocean, is another point of interest. According to the guide-book, the Lake is inhabited only by "a minute shrimp." That you will have to take on faith, as it wasn't

around the day I was there. This, however, was all I did miss on the visit, because it happened just at the time Manager D. J. Butts was leaving for his new post at Los Angeles, and Manager C. H. Talmage was arriving to take his place. The Salt Lake office is under the jurisdiction of Manager F. B. Uhrig, of Kansas City, so he, too, was on hand to help out at this time of the change in organization. The sales conference we had that week takes rank as the "top heaviest" in the history of the Company.

Salt Lake City is laid out like a checker-board. Our sales office at 41 Third Street South is well located in the wholesale section, but the building is inadequate, and there is now being erected, especially for us, on an adjoining lot, a fireproof building into which we shall move this fall. The associate telephone business is conducted at another location under a similar arrangement to Denver's.

Utah becomes dry on August 1st, on account of which some depression in business and real estate values has been prophesied, but even as early as February, when Fred Uhrig and Charley Talmage visited almost every retail and wholesale liquor establishment in the city [now wait a minute—you're wrong again], they were unable to find any possible location for our sales office that had not already been taken up by some other business. A similar condition of prosperity was to be found in Denver and the rest of Colorado which went into the "dry" column some years ago.

Your eastern tenderfoot looked in vain for some sign of the "wild and woolly" in Salt Lake City, but there was nothing but civilization on every hand. Not wishing to

have him leave in the shadow of this disappointment, the kind-hearted Fred Uhrig towed the quartette to a picture-postcard place and posed us thusly in an effort to develop



"Nick Carter" Uhrig and Three of His Outlaw Pupils, Photographed After Being Taken Into Captivity

some local color which the visitor had found wanting. Fred, himself, rose nobly to the occasion with a cowboy glare that was 100% to the good, and likewise "Buttsey," as the driver, but Charley Talmage just couldn't look fierce under any conditions, and so he did the hardest thing in the world when your picture's being taken—he just looked natural, and thereby spoiled our group.

[This instalment was supposed to conclude the series, "Swinging Around the Circuit," but you can see for yourself what a slow swinger the author is. After two months he's swung only as far as Salt Lake. Shall we let him have another crack at it?—Ed.]



Untechnical Talks on Technical Topics

THE HEAT COIL

THE manufacture of the No. 67 type heat coil, which is the standard American Telephone & Telegraph Co.'s Central Office heat coil was clearly described in the May NEWS. Reference was also made to its function, and the purpose of this article is to explain that function in detail.

The majority of telephone wires are out of doors and above ground and, consequently, are exposed to two kinds of external electrical disturbances. Under the first class may be listed lightning and accidental contact with high voltage wires, while the second class includes excessive electric currents which may flow in the telephone wires due to accidental contact with 110-volt and 220-volt lighting wires. For the protection of telephone circuits and telephone apparatus against this latter class of foreign currents, it is usual to employ fuses and heat coils placed in the telephone exchanges and at the subscriber stations. Not only is the complicated apparatus in the telephone exchange exposed to foreign currents which may come in, but it is liable to be injured by currents which are generated by the power plants within the exchange itself. Heat coils are depended upon to give the necessary protection against these possible internal disturbances.

In case a lighting wire comes in contact with a telephone wire, the amount of current which will leak into the telephone circuit depends upon the voltage of the light-

ing circuit and on the quality of contact between the two wires. If the electrical resistance at the contact is small a relatively large current will flow into the telephone wire, thereby heating it to a point where a fire may result. When this condition prevails the fuse will blow, thereby opening the circuit and preventing a further flow of current. Conditions may be such, however, that the amount of current leaking is not sufficient to blow the fuse or to injure the telephone apparatus if its duration of flow is short. If this relatively small current continues to flow for several minutes, however, it may generate heat enough in the windings of the telephone apparatus to char the insulation and otherwise cause damage. It is the function of the heat coil to prevent this happening.

The operation of a heat coil depends upon the generation of heat due to the flow of electric current through a resistance element, and the application of this heat to a junction soldered with a metal having a low melting point. This low melting solder is an alloy of the metals—lead, tin, bismuth and cadmium—and melts at approximately 165° Fahrenheit.

The No. 67 heat coil is a part of the Central Office protector, and is placed in a protector mounting located on the main frame. In figure No. 1 is shown two No. 67 heat coils placed in a standard protector mounting. The coil on the left is unoperated. The path of the normal tele-

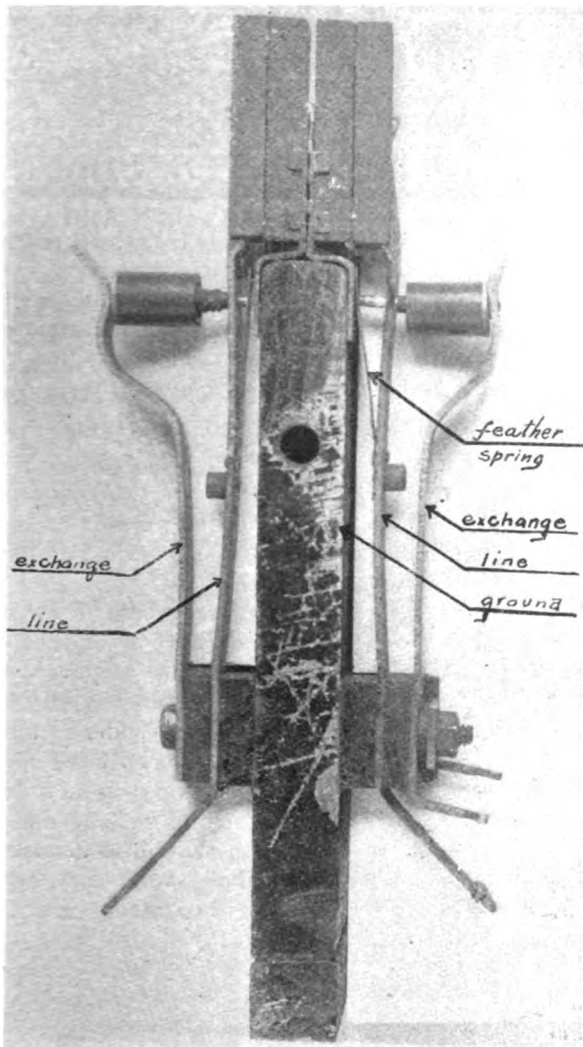

Who's Who in a Heat Coil

phone current is from the subscriber's telephone wire to the line spring, thence into the copper tube, through the heat-coil winding to the brass washer, which is in contact with the exchange spring, and then to telephone apparatus in the Central Office. When an excessive current flows in a telephone line the winding of the heat coil becomes hot, due to the passage of the current through it, and melts the solder holding the pin and tube in their proper relation. The outside spring marked "Exchange" then pushes the heat-coil shell and pin forward, and the thin or "feather" spring on the line spring comes into contact with the ground plate, as is shown on the right of the picture. The dangerous current is thus deflected from the telephone apparatus to ground. A new heat coil must be inserted in the springs before service is renewed.

The heat coil at subscriber stations is assembled in a fibre tube with the standard subscriber station fuse. In principle it is the same as the No. 67 type, except that the melting of the solder breaks the electrical circuit instead of deflecting current to ground. In the pull-out type of heat coil, which is used very little by the A. T. & T. Co., the pin is pulled completely from the tube when the solder melts, thus breaking the electrical circuit.

There are also heat coils on the market in which the winding is replaced by a small cylinder of graphite composition. The principal objection to this type of heat coil

is the inability to keep the graphite element within reasonable limits of resistance which, from the Telephone Company's standpoint, it is very desirable to do.

FOREIGN NOTES

New York

DURING the past month we had the pleasure of a visit from Mr. J. G. Van Kuyk, Sub Director of the Colonial Government Telephone Administration of Java. Mr. Van Kuyk came on a special mission from the Governor General of the Netherland Colonies to study American telephone practice, and was greatly impressed with all he saw.



Mr. J. G. Van Kuyk

London

H. Barnett, Correspondent.

We wish to anticipate the Editor's remark, "We can't afford to run any more motor car yarns" by explaining that the following is actually true:

Some few weeks back the district was visited by a particularly black—London special—fog. To those who live in the "clear air and conscience" districts we would explain that these fogs are the limit. The London papers regularly, once a year, during the fog season, print the yarn about the fog being so thick that a respectable suburban resident who went to the end of his street to post a letter, lost his way, and knocking at the door of a strange house to inquire the way home found that he was knocking at the door of his own house.

J. W. Skinkle owns the car in question, and usually gives Messrs. F. Martin and F. S. Giller a lift on the way home. On this fearfully foggy afternoon, the ferry having stopped running, this car found its way across the river to where most of the public houses are. After some slight delay it made for the main road. It there tried to burgle a bank by running against the doors. The door standing the shock, the car turned and passed by on the other side, only, however, after trying to kill W. Coomber, Master Mechanic, during its orgy of hate. The occupants of the car thought they would help the car do some thinking, so Giller and Martin hung over the side, leaving J. W. Skinkle glued to the wheel. Each gentleman had a small pocket torch with which they were locating the edge of the pavement. The car eventually took matters into its own hands and nearly knocked down two nice young ladies. Naturally, the "Three Musketeers" made the blushing damsels enter the luxurious limousine and took them home.

The "goods" were safely delivered into the arms of the ladies' mothers, who had given their girls up for lost. When things were explained the mothers agreed that the Western Electric Company was *most considerate* in sending out some of their most important officials to protect defenseless girls on a foggy night!

AROUND THE CIRCUIT

GOSSIP GATHERED BY THE DISTRIBUTING HOUSE CORRESPONDENTS

Cleveland

W. H. Quirk, Correspondent

Cleveland enjoys the distinction of having four Western Electric offices, each of which is independent of the others. Most of the telegrams (including messages from other Western Electric houses) addressed to the Western Electric at Cleveland bear no street address and consequently are delivered to the Supply House at 413 Huron Road (that's us) except for some few which are telephoned to J. T. West's residence at 2:30 a. m.

If you want your mail to go right, and if you care what becomes of your telegrams, better paste this in your hat.

Western Electric Telephone Warehouse (sub-warehouse of Chicago and handling associate telephone business only) is located at 6215 Carnegie Avenue.

Western Electric Installation Department located in Engineers Building.

Western Electric Installers' School located at 2037 E. Fourth Street.

Western Electric Supply (that's us again) located at 413 Huron Road.

Didn you never git
 A telegram from a
 Feller that sounded
 As if he wuz in a awful
 Hurry an ment biznes
 An you couldn find
 Out what he wuz in a
 Hurry about becas he
 Went and left out three words
 So as to ekonomiz in
 These hard times although
 He did put your name
 On the front end of the
 Message and tacked his own
 Onto the back end
 When you didn know
 Who he wuz and didn
 Care and you spent
 Two daze and three nites
 Trying to find out what
 He ment, And then the
 Confermashun came
 And you saw he didn
 Mean nuthin at all
 Aint that a grand and glorious
 Feeling?

It is probably old news, but it's a fact that the Cleveland Jovians won the loving cup in the "Hundred Point Contest." "Tribune" Bateman was the man behind the gun.

Recently, the Cleveland Bell Telephone girls conducted a Red Cross campaign, which has just closed. The final

count was \$5,786.50, of which the Western Electric Supply girls succeeded in soliciting 115 members. There was only one other organization in the city which secured more members. In this way the Western Electric girls showed their loyalty to their country and to the Red Cross Society, which is doing so much for their country.

Seattle

Jo Sorensen, Correspondent

During a recent visit to Alaskan customers Mr. Ward, our telephone specialist, had many unique and interesting experiences. One of them was witnessing the removal of a totem pole, the property of a recent Indian bride. In parts of Alaska it is still the custom among certain tribes in marriage for the wife to add her totem to that of her husband, be it whale, wolf, eagle or fish. Among the totems are Clan, House, Burial, Individual and Genealogical poles. Totems are read from the top downwards. Sometimes two clans are joined together, such as



half Eagle, half Fish, signifying their ancestors belonged to the Eagle and Fish clans. Totem symbols are regarded with superstitious, almost sacred, reverence, but not idolatry. The accompanying photo shows a typical pole snapped by our adventurous specialist.

Recently M. H. Nichols, one of our road salesmen, had a unique and most interesting experience near Monmouth, Oregon. Discovering to his dismay that he had but 45 minutes at his disposal before train time in which to visit

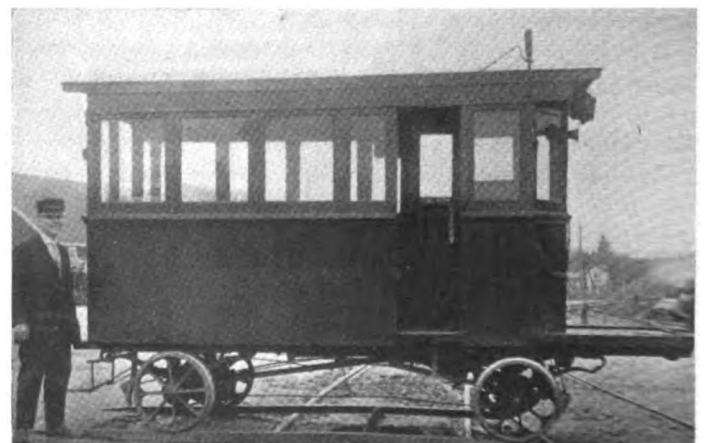

Mr. Nichols' Petrol Chariot

a lighting plant prospect in a neighboring village three miles distant, he cast about for a means of conveyance to and from his prospect. There were no roads in fit shape to drive over, and walking was out of the question. After five minutes of frantic efforts he located an idle railroad train, but no crew. Throwing discretion to the winds, much after the fashion of his kind, he climbed into the cab and, after jerking a lever or two, was off in a whirl, his suit-case and other impedimenta reposing on the ground where he had been such a short time before. The train gained momentum, and it was not before the village hove in sight that he was able to slacken his terrifying pace. Our resourceful salesman calmly made his sale of a Western Electric Lighting Plant, and with the aid of a native, succeeded in turning the train about and in due time arrived at his starting place to find a group of startled citizens about his aforementioned impedimenta.

A kodak enthusiast found the crew's cap and, after much persuasion, succeeded in securing the accompanying snapshot. We are informed that the business end of this train consists of an automobile engine of a much-talked-of and popular car, and is the only one of its kind in "captivity." The whistle is a relic and not used. A real Klaxon note is secured from a Klaxon clearly shown, sold by Mr. Nichols on a previous trip.

Nothing seems to daunt our Mr. Nichols.

St. Louis

A. C. Cornell, Correspondent



Joseph Borgel

In these strenuous war-times it is but fitting that we not only recognize the men in our organization who are "doing their bit," but also the men who have performed their duty courageously and well in the past. In the St. Louis organization we have such a character.

Our warehouse manager, Mr. Joseph H. Borgel, was born in Cincinnati, Ohio, on January 12, 1879, and in his early days studied and became an accomplished linguist, and learned to speak six different languages fluently. At the outbreak of the Spanish-American War he enlisted in the United States Cavalry and served throughout the war. While stationed in the Philippine Islands he was assigned to detached service as official interpreter to General Frederick Funston and General McArthur, and was a member of the detachment with General Funston when Aguinaldo was captured.

He was in China during the Boxer Rebellion and was with the expedition that marched to the Relief of Peking, and also saw active service in South Africa with the Canadian Mounted Rifles during the Boer War.

Mr. Borgel, with all his "Soldier of Fortune" record, is one of the most modest and unassuming members of our organization, and it has not been an easy task to secure this information and photograph. At a recent Patriotic Meeting and Flag-Day Ceremony, held by the St. Louis Jovian League of Electrical Interests, Mr. Borgel made

a very interesting address on "WHAT THE FLAG MEANS TO A SOLDIER," and was complimented on every side for his splendid effort.

Mr. Borgel entered the employ of the St. Louis distributing house in October, 1908.

Philadelphia

L. R. Browne, Correspondent

Dear Ed:

I don't know what your last name is cause you never sign it to none of your scribes no matter where it is you simply take a krack at some poor feller and sine yourself ed and i think you ought to have enough spunk if you are going to wack somebody to at least put your lastname down to or write out your first one compleet Some of us has other things to do besides sittin down and makin up stuf out of our own heds no matter how hard we try and some of it is good stuf two you don't lose no chance to bang us over the hed with something sarcastik and then sine your nickname we notis that most evry feller wat has some thing good in the news cums in for a krack now and then we wish you would put your name down so we could lay fer you and giv you wat you disserve at sum fuchure time.

—Co.

p.s. If you don't know wat Co. menes it serves you rite. we can be just as foxey as the nex feller wen it cumes to

~~.....~~
(Deleted by the Censor)

We have as much sympathy for the Russian revolution as anyone, and these revolts of the masses on the whole are great stuff, but when it comes to our contribs revolutioning about the way we sign our name—then we draw the line.

—Ed.

Possibly the reason the Pittsburgh selector was unable to find the 227 feet of floor space was that I. B. S. was doing some standing around on said space, and the man was too polite to ask him to move.

Some claim to have detected much significance in the fact that the girl employees of the Chicago office in the recent picture were all sitting on their feet. (Business of the quick springing to their defense by a few of us in Philadelphia who are of Chicago.) We know better. Chicago girls have not big feet. However, to preclude the possibility of criticism, we suggest that next time the girls of Chicago have their picture taken standing up.

To T. L. H. at W. H., Connecticut:

Can you get that plate from the Editor or else have it declared obsolete? Some of us who love you don't like it. We find it too serious, for one thing, and for another, it has not the genial expression becoming a T. S. T. M. S. T. R.

By the way, what has become of that much looked for, read-with-relish page in the NEWS?

We have a victim on the toaster now.—Ed.



At the Baltimore Flag Raising. J. E. Boisseau Making the Address

Baltimore

G. G. Young, Correspondent

Baltimore is now on the map. With a flag-raising on Monday, April 23rd, including speeches, singing and salute, the Baltimore Warehouse auspiciously flung "Old Glory" to the breeze and entered the field as a real American branch. The proceedings were worthy of the event, and two squads of soldiers from the Fourth Regiment, Maryland N. G., helped to make the event a success. A stand was erected for the occasion, and was beautifully decorated with flags. J. E. Boisseau, Publicity Manager of the Chesapeake and Potomac Telephone Company, made a spirited patriotic speech, telling what co-operation

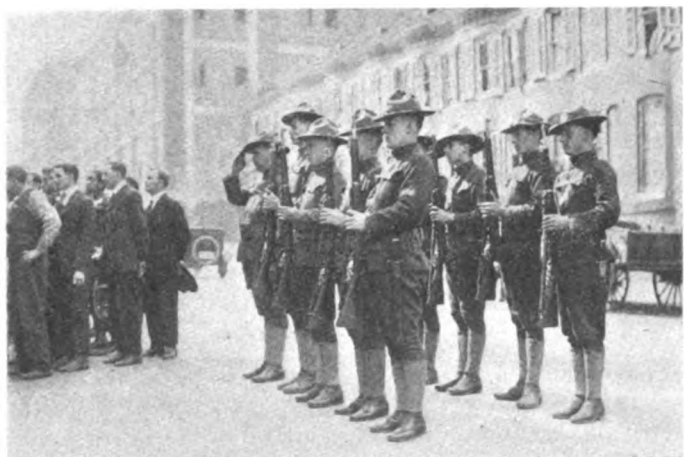

The Soldiers Saluting As the Flag Was Raised At Our New Baltimore Office

the A. T. & T. Co., in connection with the Bell interests and the Western Electric Company, were doing for the Government. The flag was raised by Scout Master B. C. Cooper and M. E. Boss, Baltimore Shop Foreman.

The Baltimore girls helped to make the flag-raising a success with their voices as they sang the "Star-Spangled Banner" with a gusto.

Pittsburgh

I. B. Stafford, Correspondent

We put a new salesman upon the road giving him instructions that his reports must be thorough. The first report read:

"To-day met Mr. 'So and So' of 'Such and Such' a Com-

pany, and had an interesting talk. I find that he *belongs to the same order** that I do. Possibly I can get some business."

* Was it one of those small orders?—O. D. S.

Charlie McClary, our long, lean salesman, has just purchased one of those foreign cars known as a "Ford." While enjoying one of his first drives he tried to beat a street car across the street. The motorman noticing his trembling hand and his bewildered eyes, threw on the emergency brake as well as the sand and succeeded in bringing the trolley to a stop within a foot of the big "Ford." The motorman threw open his door and in a disgusted way said: "Say, you big simp, don't you know you can't get under these cars with your top up?"

The Western Electric Company, as part of its advertising scheme, is furnishing window decorations for various campaigns, free of charge. Our Display Room, which is opposite to the entrance of our office, has been equipped with a large window. This window is dressed weekly by our various specialists. Our visiting customers have made many interesting comments on our decorations, and we feel that it is doing a good work toward helping along the cause besides giving our specialists valuable suggestions, which they in turn may offer to our customers.

New York

H. H. Gamble, Correspondent

Are you a statistician? No! Well, how do you manage to get anywhere on the elevators? Oh! You walk—well, that's the best way. Climbing six or seven flights of stairs, shaking hands with all those you meet, and getting a stopover at the sixth floor for lunch, you can manage to save a few hours over the elevator service. By puzzling out the directions posted on each floor with a pair of near-sighted glasses, and using a slide rule, you find out which elevator stops at your floor and the floor you are going to between the hours of half past now and then. After all your mental activities you discover you have gone over the time limit and missed the day's car—result—you increase the demand and price of leather by using the stairs. You ask, who is responsible for this? Well, on account of the censorship, we cannot reveal his name—an engineer? Of course. One of our inventors? Most certainly. What other complicated invention has he made? Oh, nothing as complicated as the elevator schedule—just the inside of a telephone switchboard.

The Engineering Department informs us that the elevators traveling, under the new schedule, saves 13,723 1/7 seconds per round trip. Operating under the old schedule, a round trip took 2 minutes, 39.876 1/9 seconds. The time now is but 2 minutes, 26.152 61/63 seconds. If you don't believe it, subtract it yourself.

DARK IS THE NIGHT

No longer gleams throughout the night
Our wondrous sign of faded light;
The lights were dim the frame was rusted,
Many sockets were entirely busted.
So we tore it down to put it in shape,
When the war came along! Bring on the crepe.

Newark, as usual, has no contributions for the NEWS this month.

WAR EXTRA ON NEW YORK LOCATIONS!

The storming of the new 28th Street warehouse was successfully carried out during April. Small, but important gains being noted as wagonfuls of merchandise, night after night attacked the new location. As space was vacated at hill number 463 West, it was consolidated by the Engineering corps, who promptly prepared it for permanent holding. The entire front is now in shape except the record room, which will be dropped, by the aid of miners and sappers, several floors on an auspicious date.

At the present time, when practically all raw materials and manufactured products are bringing record high prices, it may be of interest to note some of the extraordinary figures realized for our junk. Practically all grades of scrap material were sold during 1916 for prices greater than ever before realized. A review of the situation shows that the scrap handled by the New York house during 1916 was valued at about \$1,450,000. The principal items going to make up this total were approximately:

- 3,150,000 lbs. bare copper wire
- 501,000 lbs. mixed insulated wire
- 2,716,000 lbs. cable and sheath
- 36,000 lbs. battery plates
- 35,000 lbs. tinsel cords
- 34,000 pieces incandescent lamps
- 15,000 lbs. rope
- 60,000 lbs. cable clippings
- 227 Troy ounces platinum

The chief item in value was bare copper wire, with a total value of approximately \$950,000, the average scrap price for the year being about 30 cents per pound.

The next item in importance was paper insulated lead-covered cable, the copper from which is included in the copper figures.

Such second-hand material as motors, office furniture, gasoline engines, Oriental rugs, safes, blueprint machines and batteries were sold to second-hand dealers, this class of material being disposed of on advertised sales.

Our total accumulation of 227 Troy ounces of platinum, with a small quantity of gold and iridium, due to the extraordinary situation created by the war, was sold for a total of approximately \$19,000, or an average price of \$85 per Troy ounce, this average being over four times the Government price of gold (\$20.67 per Troy ounce). The larger part of the platinum was in the form of points from telegraph instruments. The platinum was refined in the chemical laboratory of the engineering department, and was disposed of to the highest bidder on advertised sales.

Denver

Miss M. Cassidy, Correspondent

We sent an order from one of our customers to a nearby distributing house. Said house filled the order and billed our customer direct. When taken to task they offer the following original defense—which we admit is humorous, to say the least:

"I find that our cost on it was \$72.63 and that we sold it for \$80.70. If you will figure this out you will find that in case we had billed you we would have billed \$72.63, plus 5% service charge, which would have made the total billing to you \$76.26. As the difference between this \$76.26 and the amount we sold it for is only \$4.44 you, of course, have no claim, as the amount involved is under \$5.00."

If our service man is arrested for stealing chicken feathers, or any other similar crime, we will send for the writer of the above to defend him.

Dallas

S. Zercher, Correspondent

Herewith are some pictures of our patriotic parade held April 10th. The official count shows that we had ninety-six in line. More than fifteen thousand people participated in the parade.



R. W. Van Valkenburgh, a Marshal of the Parade



C. K. Lawson, Texas National Guard



Ready to Leave the Building

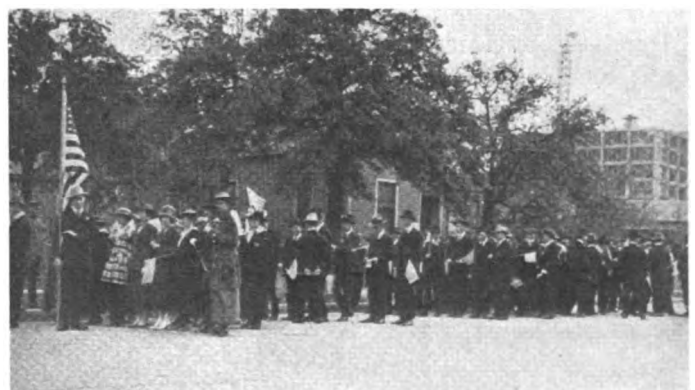

Before the March

A dinner-dance was held on April 12th in the palm garden of the Adolphus Hotel, which was decorated with flags.

Just to keep the record straight we find it necessary to ask Chicago for a show-down on their statement in the April NEWS with regard to military service in Texas. Sergeant Schleicher has an excellent record, and we congratulate him on having such a good press agent. Two of our men were on the border some time themselves. Their records are below:

C. K. Lawson—Regimental Supply Sergeant, 4th Texas Infantry, stationed in the Big Bend country from May 6, 1916, to March 7, 1917.

A. B. Clayton—Private, Company B, 2nd Texas Infantry, stationed at Corpus Christi and Donna from May 6, 1916, to March 26, 1917.

There is just one question we would like to ask: Where did Sergeant Schleicher find such cool weather as 92 degrees in the shade? We are looking for such a place to spend our vacation.

Atlanta

O. Whitmire, Correspondent



Chicago

R. F. Young, Correspondent

A new household utensil that is apt to make its appearance on the market here soon, unless the weather moderates, is an electric warming pad for gardens.

Our latest alibi, now, when we fall down on service is that the order is—

“SOMEWHERE IN HAWTHORNE.”

D. H. F.

Both New York and Atlanta have expressed considerable discontent lately because their sub-warehouses fail to contribute to their columns in the NEWS. Our suggestion is that they call them “Branch Warehouses” instead of “Sub-Warehouses,” and then note the result.

Aleck, our progressive young office person, has invented a submarine exterminator that promises to revolutionize warfare. The invention consists of a dynamite bomb surrounded by electric magnets. These bombs would be set afloat and any metal object, either on or under the surface, such as a submarine, would attract them and presto! —the bomb coming in contact with the submarine would

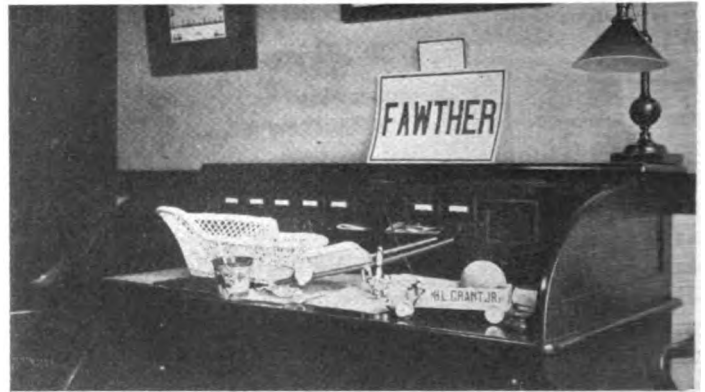

This is How Sales Manager H. L. Grant's Desk Looked On the Morning of April 14th, the Occasion Being the Birth of a Son

explode and destroy it. It was hinted to him that these bombs might also destroy, in the same way, all of our precious steel warships, or any other friendly ships, that might be about, and Aleck replied that that was a little detail in connection with the invention that he had not yet been able to perfect.

What was the best feature of the May NEWS outside of the Chicago column? Our one guess is that it was the picture of the alfalfa-fed Kansas City girls, posed behind the home-made American flag.

Why drag in Chicago?—Ed.

In the citizenship blanks which we were all required to fill out, you will doubtless recollect, was a question reading as follows:

“What kinds of work can you do in addition to what you are doing now?”

A good many of our girls answered, “*Domestic Science—Expertly.*”

It is presumable that, following the return of peace, Mr. Ketcham would consent to the publication of the names of the above young ladies for the benefit of any men who are contemplating the matrimonial plunge.

One hundred and sixty-five employees of the Chicago house met a few days ago at an efficiency dinner. Among other things, it was decided at the meeting to declare ruthless warfare on some of our friends of long standing. It is now a misdemeanor at Chicago to use certain expressions in correspondence, and for a second offense one is apt to be sent up for life and ten years more. Here are some of the blacklisted phrases:

We beg to acknowledge
 We beg to inquire
 Your kind favor received
 We are sorry to learn
 Contents duly noted
 This is to inform you
 We wish to advise
 In reply will state
 We would ask or request
 After investigation we find
 Our records show.

May 1st, Moving Day, was observed along Mahogany Row, in the form of a general shake-up of the private offices. George “Husky” Porter, of the Railway Sales Department, is the latest to make his headquarters along the “Row.” He has promised to have a file of timetables, or

something else, on tap in his half of the office formerly occupied by Sales Manager Grant.

**Chicago's Agricultural Battalion
Gardening in Dead Earnest, Not Merely as a Back-
Yard Sport But As a War Measure,
Has Set In**



Miss Frieda Hennig, of Our Order Entering Division, Posing As the Newest Type of Patriot. This Picture Was Taken in Her Own Private Little Garden Plot, To Tūl Which She Arises Each Morning At Five O'clock

"Wall-l-l, my tater crop I reckon's goin' to be a hum dinger this season. Say—I'm 'spectin' to realize 'bout fifty bushel to the acre. And, gosh all fish hooks, if they keep on goin' up in price I'll be able to hire Sousa's band to play right at my feet all next year. And bugs, too—Gee, whiz, I never did see so many since I moved away from 125th Street, New York!"

The scene of the above monologue is the crowded elevator in our building a few minutes before 8:30 A. M. Power Apparatus Sales Manager Gleason, with an eye to

business, pricks up his ears and starts to feel about in his rain coat for that little volume of ready reference, "The Farmers' Electrical Handbook." He imagines he sees the order in his hands right now for that Farm Lighting Plant, and he looks around preparatory to offering the prospect a Roi Tan by way of introduction.

He expects to see a prosperous, bucolic individual, but is disappointed. Instead his eyes fall upon our Bill Clerk, who pushes a pencil all day and pulls weeds and hoes corn on his own little plantation night and morning. His intimate association with the soil is beginning to affect his vernacular. He aims to be an agricultural plutocrat in all that the name implies.

The above is only an incident showing what is going on in Chicago and its suburbs this summer. We are all doing it; Mr. Ketcham, Mr. Grant, Mr. Holmes, and so on, right down the scale, both male and female. To make a long story short, we are getting back to the soil with a vengeance.

Our Cleveland Telephone Warehouse organization has hired a half-acre for intensive cultivation adjacent to the warehouse. Most of this ground has been planted already with piece part 88800 spuds per Spec. C. L. 6215.



John Valenta, of the Chicago Sales Department, in the Act of Demonstrating That He Can Do Real Work When the Occasion Arises



George H. Lounsbury, Chicago Sales Department, Taking His Morning Exercises Right Out in the Middle of His Own Potato Patch



Stores Manager West's Ford Furnishing the Motive Power for Plowing Up the Potato Patch Next to Our Cleveland Telephone Warehouse



Our Cleveland Telephone Warehouse Agricultural Crew Lined Up for Inspection. BACK ROW—Head Farmer Lewis, Worm Specialist Schramm, Chief Grubber Brown, Grub Inspector Bloom. FRONT ROW—Hoe Specialist Stackhouse, Plowboy West, Waterboy Brenkman



Salesmanager H. L. Grant Fighting the High Cost of Living in the Front Line Trench of His Own Vegetable Garden

ROLL OF HONOR

CURRENT AWARDS OF OUR SERVICE BADGES

To Be Awarded in June

THIRTY YEARS			
Kraven, J., Hawthorne.....	June	—	
TWENTY-FIVE YEARS			
Bancker, J. W., Hawthorne.....	June	2	Frazer, C. N., Hawthorne..... June 15
Budenbender, W. G., Hawthorne.....	June	30	Haslam, E., Hawthorne..... June 16
TWENTY YEARS			Higgins, E. C., Hawthorne..... June 16
Bicknell, D. E., Hawthorne.....	June	6	Dietz, J. W., Hawthorne..... June 28
Conniff, T., Hawthorne.....	June	22	Smith, F., Hawthorne..... June 30
Brennan, S. B., Hawthorne.....	June	29	Darrah, H. L., New York..... June 23
FIFTEEN YEARS			TEN YEARS
Hintz, W., Hawthorne.....	June	5	Harris, Martha, Atlanta..... June 24
Polak, C., Hawthorne.....	June	9	Carlson, C. O., Hawthorne..... June 14
Wheeler, L. M., Hawthorne.....	June	9	Marth, W. J., Hawthorne..... June 17
Bruebach, H., Hawthorne.....	June	12	Spangler, J. J., Hawthorne..... June 17
Waghorne, H., Hawthorne.....	June	12	Raab, M. J., Hawthorne..... June 18
Wilkerson, F. B., Hawthorne.....	June	13	Scherrer, C., Hawthorne..... June 18
Pierce, E. H., Hawthorne.....	June	14	Jessup, R. D., Hawthorne..... June 19
			Kuehl, W., Hawthorne..... June 22
			Avery, A. O., Hawthorne..... June 24
			Burke, Elmer J., Philadelphia..... June 28
			Rohrman, N. L., Philadelphia..... June 30
			Whitehurst, Cecil B., Richmond..... June 20

J. Kravens

Western Electric metal finishers thirty years ago used to drink about ten times as much water as they do now. J. Kravens knows, because as the "kid" in the finishing department-one of his jobs was to carry the drinking water and the ice for it from the first floor of the old Clinton Street shops. To be real Kiplingesque, Jim was the department's one and only "Gunga Din"—and the number of trips he used to make in the dog days was large. Nowadays, with sanitary drinking fountains all over the place, nobody cares how much a man drinks, but in the old days Jim certainly did hate to see a bunch waiting around the water cooler. However, between times, when he wasn't carrying water, Kravens learned the japanning game, and he has stuck to it ever since. He is now one of the section bosses in the japanning department.

W. G. Budenbender



Twenty-five years ago W. G. Budenbender entered the New York shops as a polisher of screw machine work. He didn't stay a polisher for long, however, but soon graduated into the hand-screw machine-operator class where, under the output bonus system, he was soon one of the most highly paid operators in the department. Then he got a job on the automatics and again soon worked up among the leaders. He was transferred to Hawthorne in 1913 and is now a section boss in the automatic screw department. You see "Bood" has a way of getting what he goes after—unless it is a greased pig. In one of the outings of the old New York shops at Greenwald, Staten Island, he tried his hand—or rather his legs—at that too. Now to catch a greased pig you must clamp him between your knees. But suppose your legs are not built to clamp to-



J. W. Bancker

gether—how do you catch one then? Budenbender tried to solve that problem for some time, much to the amusement of the pig, until it was captured by some one else after "Bood" had transferred most of its grease to his trousers. But he has probably forgotten all about that years ago, even if his friends haven't. Anyway, one more thing that he is going to get is a third star for his service button, due this month.

J. W. Bancker

The very first edition of the News contained an article on "The Man Who Knew the Answer." He started as an office boy. Two years later he was head of the payroll department. From that time on he jumped to more and more responsible positions in rapid succession—head of the shop cost department, secretary to the shop superintendent, head of the material department, head of the stores department, and finally assistant works manager. Those of you who "know the answer" have already said: "J. W. Bancker." Mr. Bancker is now assistant general superintendent at Hawthorne, in charge of the clerical branch, the production branch, and the employment and welfare branch. He gets his 25-year service button this month.

D. E. Bicknell



D. E. Bicknell

D. E. Bicknell, who has charge of the apparatus draftsmen at Hawthorne, is now in the predicament of a man who has to swallow his own medicine or deny its potency. For "Bick" was assigned to the inspection department in New York shortly after coming with the Company in 1897, and while on that job one of his principal amuse-

ments was jumping the drafting department to get limits changed on some part that the shops couldn't make to pass inspection. In August, 1908, he was transferred to the drafting department, since when he has forgotten all those "change of limits" arguments—except the answers to them. "Bick" doesn't smoke, drink, chew or run a buzz wagon. In fact, he is free from all the modern vices except attending the movies, and he took his first antidote for that a short time since. It seems that, while he and his wife were out seeing "The Great Diamond Robbery," or some such thriller, a few nights ago, they missed some really clever acting along the same line at home. Not only that, but they missed everything of value in the house. Luckily, however, "Bick" was wearing his service button, so he won't have any explanation to make when it comes time to turn it in for a two-star emblem this month.

T. Conniff

Nobody can know everybody else at Hawthorne unless he has a mind like a city directory, but T. Conniff can probably call as many by name as any person around the Works. He began making Western Electric acquaintances twenty years ago at Clinton Street, and he has kept it up ever since. Tom took an active interest in the Western Elec-



T. Conniff

tric Benevolent Association in the early days, and many of its members were introduced by him. Mr. Conniff's work for the Company has all been of a clerical nature, although he has worked in various departments. At present he is adding stars to his service button in the tool records section of the hand-screw machine department.

S. B. Brennan

Telephone assembling was S. B. Brennan's first job with the Company. Since then he has worked at telephone testing, line-material inspection, switch-board inspection, stock-room work and equipment engineering. He is now in the exchange equipment section of the price department. When he isn't setting prices on switchboards, "Beau's"



S. B. Brennan

hobby is setting hens on eggs and hatching out the finest White Orpingtons in the suburb of Berwyn. From one pen of 15 pullets he gathered 299 eggs during January. And yet he claims he is not a millionaire. Well, maybe he ate them instead of selling them at January prices.

Mr. Brennan gets his 20-year service button this month.



Their Badges Now Show One Star



F. B. Wilkerson



E. C. Higgins



C. N. Frozee



H. Bruebach



E. H. Pierce



Chas. Polak



Edward Haslam

**J. C. McDonnell Forty-Three Years
a Western Electric Man**

It is not often that the News has the pleasure of recording the awarding of a six-star service badge. In fact, it has heard of such a thing only once before, a few months ago, when C. E. Scribner received one. At the same time this special badge was made up for J. C. McDonnell, of Hawthorne, who, with forty-three years of service to his credit this month of June, makes some of the other badge recipients whose names have appeared recently on these pages seem like mere youngsters in comparison. Mr. McDonnell really became entitled to his 40-year badge in 1914, but at that time no such badge had yet been planned. It has recently been presented to him.

Are You Interested

in knowing how you can help float the Liberty Loan? The Company has arranged a plan of purchase through pay deductions which is fully explained on page 24.

Turn the page.

Around the Wax Pot



One of the Favors Presented at the Installers' Banquet Purports to Show an Installers' Training School in Full Blast. W. A. Titus, Who is Said to Have Posed for This Gem, Considers the Artist Took Unwarranted Liberties With His Figure

songs, stories, and a lot of good-natured fun poked at those present.

TH E R E have been banquets and banquets, but none in the history of the Installation Branch to equal the get together spread held in Chicago April 5th. Ninety-two men from all departments and from nearly all districts rubbed shoulders and got better acquainted with each other through the mighty effective means of



"Ben" Skinner Congratulates Toastmaster DeVoss. The Presentation of the Medal, Which May Be Faintly Discerned on the Manly Bosom of the Aforesaid DeVoss, Was One of the Special Features of the Installers' Banquet. Mr. DeVoss is the Champion Tongued Toastmaster of the World. At Least No One Has Offered to Dispute His Title Up to Date

Toastmaster DeVoss and C. J. Hurley, the dean of our story-tellers, provided most of the chin music from the head of the table. Superintendent B. K. Filer opened the ball with an interesting talk in which he outlined a number of the important developments of recent times and dwelt in detail on the problem of education for the beginner.



Installation Branch Annual Banquet, Chicago, April 5th. Mr. Wolff Objects to the Joyless, Unfed Appearance of Our Banqueters. How About This Bunch of Installers? Most of Them Look Happy, and It Will Not Strain Your Eyes to Pick a Few Who Look Fairly Well Fed

The evening was one long laugh. The Production Department trio and the Installation Branch Jassack Band, with Ben Skinner as leader, furnished a good share of the fun. We hadn't suspected that Ben had so much rousic in his soul.

By the way, we tried to get a picture of that band, but the photographer refused to take any further chances with his camera.

The Installation Branch Bowling League brought its winter season to a close last month. While no records were broken, the season's activities were marked with an abundance of good fellowship and of the real "get together" spirit.

Standing of the teams for the series:

Team No. 1	Team No. 5	Team No. 2	Team No. 3
Fairweather	Simpson	St. John	Olschner
Frydle	Hynd	Hurley	Bennett
Titus	Zachata	Hackner	Bottger
Kading	Burke	Painter	Galinsky
Hansen	Molitor	Lindgard	Scherzer
Total pins, 7202	Total pins, 6503	Total pins, 6456	Total pins, 6308
Team No. 7	Team No. 6	Team No. 4	Team No. 8
Hill	Mason	Johnson	Abes
Page	Morrison	Daley	Walters
De Voss	Lorrige	Iverson	Hackburg
Peckham	Barry	Ficken	Kammeron
Bartlett	Honnold	Stocker	Malley
Total pins, 6151	Total pins, 6109	Total pins, 6052	Total pins, 6004

Modesty forbids stating how many games were required to roll these totals. —W. O. Titus.

With all due respect to our brothers in the south, who, from the evidence outlined in a recent issue of our publication, might be considered experts with the block and tackle and lifting jacks, and also to our New York organization whose hair- or roof-raising achievements is well worth attention, and let me add that in J. J. Clifford, the BEACON of 203 Broadway, they have a very able and most



•Who Said There Were No Bowlers in the Installation Branch? Evidence to the Contrary—Captain Fairweather and Manager St. John and the Winning Team With the Trophy Awarded for the Season Just Closed

convincing press agent. I quote from a letter received not long ago from South America, the writer of which is H. J. English, who, up to June of 1915, was connected with our Installation Branch in the capacity of Division Foreman. He is now associated with the telephone company operating in Brazil.

"Last August I started the installation of a new exchange, and for four months I worked from 7 a. m. to 10 p. m., with only one man who understood the business, and with 80 to 95 'rookies.' I had Japs, Spaniards, Italians, Portuguese, Englishmen, Frenchmen, Germans, Russians, Belgians, Canadians, Armenians, and one American from Chicago. Imagine the difficulties arising from a 'melting-pot' containing these ingredients." —M. SHANNAHOFFSKI.



The Western Electric in Rio Grande City

RIO GRANDE CITY, Texas, albeit 23 miles from the end of a railroad, has its own electric light plant. Western Electric material is almost exclusively used in the city, whose population is 1,200 Mexicans and about

40 Americans. Besides the electric light plant, owned by Messrs. Calixto and Jose Valle, both the movie houses in town use our materials, having individual light plants, and the Star Telephone Co.—O. T. Hazleton.

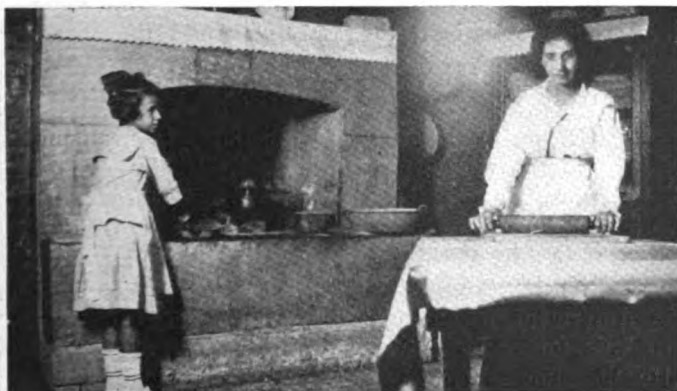

Now That They Have Electricity in Town, It Looks Like a Chance for a Range Sale. Mrs. Valle's Kitchen, with Charcoal Fire

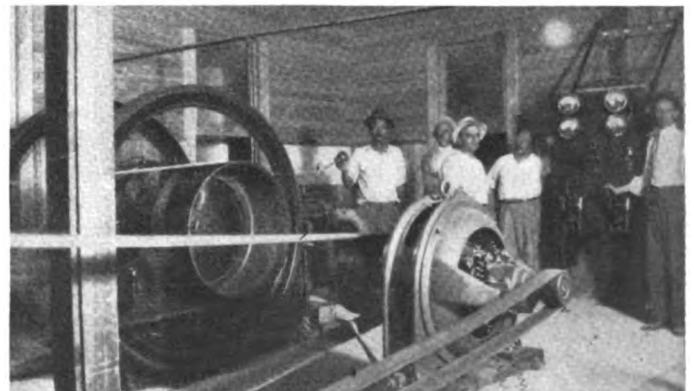

Messrs. Calixto and Jose Valle and Salesman Faubion (right) Turning on the Electricity at Rio Grande's New Light Plant

Western Electric News

PUBLISHED
MONTHLY

FOR THE
EMPLOYEES

BY THE WESTERN ELECTRIC COMPANY, INCORPORATED

H. B. Thayer, *President*
W. P. Sidley, *Vice-President and General Counsel*
Gerard Swope, *Vice-President and General Sales Manager*
J. W. Johnston, *Treasurer*
G. C. Pratt, *Secretary*
C. E. Scribner, *Consulting Engineer*
H. A. Halligan, *Vice-President*
A. L. Salt, *Vice-President and Gen. Purchasing Agt.*
H. F. Albright, *Vice-President and Gen'l Superintendent*
F. B. Jewett, *Chief Engineer*
R. H. Gregory, *Comptroller*
Office of publication and address of President, Secretary, and Treasurer, 195 Broadway, New York City.

BOARD OF EDITORS

P. L. Thomson, *Editor-in-Chief*
P. K. Condict
W. F. Hendry
John Colter
E. C. Bstep
F. J. Holdsworth
S. W. Murkland
H. D. Agnew
Reed Calvin

Subscription: \$1.50 per year, except to employees of the Western Electric Company, to whom copies are furnished free of charge.

All communications and contributions should be addressed to WESTERN ELECTRIC NEWS, 195 BROADWAY, NEW YORK.

Matter intended for any given issue must reach New York not later than the 12th of the preceding month.

VOLUME VI

JUNE, 1917

NUMBER 4

YOU AND THE LIBERTY LOAN

LIFE seems much the same as usual. Your city goes on smiling. The crowds still stroll the street. The news headlines are a little larger and band music a little commoner, but life has not changed much for war, has it?

For the most of us it has not. But do not let the surface movements trick you. We are deep, deep in the greatest war that the world has ever known, and our immediate responsibility—the responsibility of feeding and financing our Allies, who are bearing the brunt of the fighting—is becoming a heavier one each day. Life may seem to go on just the same—and to the thoughtless perhaps it will—but it can never be the same to the man, woman and child of *spirit*. For, there are things to be done, burdens to be shouldered.

Of the fact that men, women and children are already shouldering burdens we must be proud. And it is literally a fact that even the children of the country are helping, for any day you can see the boys and girls in their gardens. They are helping feed the Allies, helping win the war. And it is extremely gratifying for the News to note that it is carrying in its news pages this month accounts of widespread garden activities on the part of Western Electric men. They are doing their bit in an agricultural way.

But how of financing? "Count on us for feeding and financing," we have told France, Russia, Italy and England. There are great loans to be floated as well as great crops to be raised. Have you considered how you can do your share toward financing our Allies?

There is a very easy and practical way in which you can help. By periodical deductions from your pay

you can buy Liberty Bonds and help your Government and its Allies materially. And, of course, this involves practically no sacrifice, for you get 3½% interest, and your bond is probably the safest and strongest in the world.

For any employee who wants to buy a Liberty Bond the Company offers its services. Here is the way:

First, determine how much of your pay you wish set aside each week. For convenience' sake the Company has determined that this portion must be in multiples of \$2 per week, i.e., \$2, \$4, \$6, etc. Next, tell your immediate superior of your desire to buy a Liberty Bond. They are sold in denominations as low as \$50. Your superior will see that you are furnished with a printed request on the Treasurer (see the form on the opposite page). Then, all that it is necessary for you to do is to fill in the amount you have decided upon as what you want set aside, date and sign it, and forward through your immediate superior to the Treasurer of the Company, 195 Broadway, New York City.

The receipt for the first deduction from your pay will constitute the acknowledgment of the request. Deductions will be made as soon as possible after June 14—the date by which you must mail your printed request to the Treasurer. When deductions have amounted to the cost price of the \$50 bond you will receive the bond itself.

The Company will purchase these bonds and deliver them to you at their cost, but at no higher price than the quoted market price at the time of delivery, plus interest at 3½% from the last interest date (June 14th or December 15th) to the date of purchase.

The following illustrates how this scheme of deduction from pay will work out:

\$2.00 per week will pay for one \$50 bond in approximately 25 weeks—or 2 bonds per year.

\$4.00 per week will pay for one \$50 Liberty Bond in less than 13 weeks—or 4 bonds per year.

\$6.00 per week will pay for one \$50 Liberty Bond in a little over 8 weeks—or 6 bonds per year.

\$8.00 per week will pay for one \$50 Liberty Bond in a little over 6 weeks—or 8 bonds per year.

Those on the monthly payroll may pay, through deductions, in multiples of \$10. Separate forms have been provided which they can obtain from their local cashier.

Thus the Company has made it easy for you to do your bit in a financial way. Remember that your applications must be in the mails by June 14th.

WAITING TILL THE WAR SITUATION CLEARS UP

ARE you one of those who believes in "waiting till the war situation clears up" before going ahead to buy things that you really need? Is your portion of the purchasing power of the nation going to be idle at this time?

From buying absolute luxuries let us hope so—for no American citizen ought nowadays to be running up bills for unnecessaries. But as to the staples of life, the same slogan seems to be: "Let there be *economy* but no *paralysis* of business."

Great Britain entered the war with the slogan, "Business as Usual," and awoke a couple of years later to find that she had made a mistake. Now she distinguishes between essentials and non-essentials in business.

Of all times, just now the business life of the nation must continue to flourish. Business needs your support, small though that may seem to you. If you and 10,000 other Western Electric men hoard money—refrain from buying the normal necessities, then your lack of patronage will surely contribute to a paralysis of business, which in turn will place an additional burden upon the State.

Remember the importance of the sinews of war. There are great taxes to be raised, great loans to be floated. Business must flourish to enable these taxes to be paid out of its profits and the loans to be made out of our surpluses. Insignificant as an individual income may seem to the recipient, in comparison with the billions upon billions that we read of in the newspaper columns every day, the need of personal economy in this war is going to be an extremely important one. But let it be an intelligent economy.

"LIBERTY LOAN"

To the Treasurer,
Western Electric Company, Inc.,
195 Broadway, New York, N. Y.

In accordance with the published offer of the Company of May 25, 1917, I hereby authorize you to deduct from my wages, until further notice, in multiples of \$2, \$. per week for the purchase of United States Government 3½% bonds (Liberty Loan). It is understood that delivery of each \$50 bond will be made when deductions aggregate the purchase price at the current rates on date of delivery, plus interest.

Dated 1917.

.....

(Signature of Employee.)

Location of Employee.
Department or House.

Town State

Form 1161-GN

This is a Reprint of the Special Form Provided by the Company for Those Wishing to Buy Liberty Bonds According to the Method Explained on the Opposite Page.

Success Through Good Health

By Edwin F. Bowers, M.D., Author of "Side-Stepping Ill Health," "Alcohol—Its Influence on Mind and Body," "Zone Therapy," etc.

ONCE upon a time there lived in Italy a nobleman named Luigi Cornaro. You would never have known, without being told, that he was a nobleman. For he was a pale, little bit of a man who spent his time not in making himself generally useful to the king, but in consulting doctors, and in taking large quantities of disagreeable-tasting medicine.

This nobleman made it his business to see all the greatest and most intelligent doctors of his day, and they, without exception, told him that he was in a very bad way, that he had but a short time to live.

Now, this nobleman was undersized and emaciated, but what there was of him was largely nerve and backbone. So when these wise and high-priced doctors gave him his death-sentence he then and there made up his mind to disappoint them.

He inaugurated a "cutting-out" campaign. Instead of eating food that "was good" he ate only what "agreed." He subjected everything eatable to one test. If it didn't distress him he adopted it as part of his steady diet. If it disagreed he put it in the *index expurgatorius*. He followed the same course with all his habits of living. Anything that proved detrimental to his health he tabooed.

He was among the first ever to adopt the open-window habit—at that time held to be pernicious in the extreme, as it let in the night air. The doctors of those days didn't know that night air was the only kind of air there was at night, and that it was much better for being pure than it was after being used a half a dozen times. Also, our noble

Count embraced the "exercise for exercise-sake" habit, at that time rather an unusual proceeding.

However, the consequence was that soon he began to gain in strength and appetite. His ability to assimilate food was increased, as was also his muscular power. His mind cleared, and he became the leading advocate in a movement to reform doctors—which, as everybody knows, is almost a hopeless task.

By scrupulously avoiding the things which experience taught him to avoid, and by living an abstemious and natural life, he attained almost a century of years. When he was ninety or more he wrote a most interesting book, proving that bad health was an asset—provided one took good care of it—and, on the other hand, that the rugged, red-cheeked rowdy, by abuse of his physical functions, indubitably shortened his existence.

Our nobleman led a busy and useful life. His chief diversion consisted in attending the funerals of all the doctors who had told him he was to die young. And so his taste in bouquets was developed to the highest pitch of excellence. Also, he lived happily ever after.

What Cornaro accomplished can be done by any one with courage and persistence. And much more certainly than he did it, because we now know what bad foods do to good health, and what good foods do for bad health. Also, we understand the reason why it is necessary to burn up effete products in the blood by those Bunsen burners—the lungs. We know, and can accurately advise, as to the proper kind and amounts of exercise adapted to each in-

dividual. For the Science of Medicine and the Science of Common Sense are no longer considered incompatibles.

But, above all, we are recognizing that a person's efficiency—physical, mental, and even moral—depends very largely upon whether he is properly nourished, properly cleaned—inside and out—properly "aired," and properly clothed. And also we have proved, beyond any shadow

of a doubt, that, unless one happens to be afflicted with one of the very few incurable diseases left, he may, by making a business of living, and by studying his peculiarities or weaknesses, overcome almost anything that may afflict him, and thereby become strong, rugged and robust, and live to be a hundred—as did Luigi Cornaro.

AMONG THE ENGINEERS



NEWS OF THE DEPARTMENT FROM NEW YORK AND HAWTHORNE

Hawthorne

W. E. Viol, Correspondent

The Monday night bowling league of the Hawthorne equipment engineering departments brought its season to a successful close with a handicap bowling tournament. G. C. Joseph and V. W. Langborgh became the proud possessors of the gold and silver watch fobs with scores of 602 and 533, respectively. Fifteen other prizes were awarded.

J. L. Harrington, A. E. Robinson and W. E. Viol won the individual high game prizes, with totals of 208, 200 and 200, respectively.

The Monday night league was composed of eight five-man teams. The following were the prize-winning teams:

	Won	Lost	Pin Avg.
Team No. 4 (J. Carr, Capt.).....	31	11	681
Team No. 2 (W. E. Viol, Capt.).....	27	15	642
Team No. 7 (E. B. Rice, Capt.).....	25	17	662

IT CAN'T BE DONE!

We hate to admit it, but there seems to be a peace-at-any-price advocate among us, as witness this recent change-order: "Change red-white-blue and red-white-orange loop leads to yellow and yellow-green loop leads."

HEARD IN THE SHOPS



ACTIVITIES OF THE MANUFACTURING DEPARTMENT AT HAWTHORNE

Who's Who at Hawthorne?



Who has to have a seer's far sight to order shop supplies? (If he should slip these days—good night! The shops would have his eyes!) Who's lost at least a herd of goats to firms that "Beg to state this cancels all our former quotes; also our promise date"? Who totes around a G'o'gia drawl that surely is a peach, yet "cain't see what the deuce you-all fawnd quee-ah abawt mah speech"? Who, when the band plays "Dixie Land," most



A Light Plant on Wheels

One of the things that has interested Western Electric men of a mechanical turn of mind is the Farm Light Plant Demonstrating Auto. Agent J. W. Stokes, Jefferson City, Mo., owns and operates this one.

wildly claps that gem? (Come, guess this time—now. Try your hand.) Right! Marshall, one P. M.

Our Mail Sustains Divers Damages

At the bottom, as the kind old lady remarked, the crews of the Kaiser's kultur-boats may not be half bad, but the trouble is to keep them there. Which serves to introduce "Exhibit A," Hawthorne mail, American borne, which knows all about U-boats and their pleasant ways.

This envelope of correspondence left Hawthorne for London about February 24th and returned April 28th, smelling of the sea and bearing the label: "Damaged by seawater. Found loose at Liverpool." That was all, but it doesn't require an especially expert suspicioner to suspect who led it astray and induced it to get pickled with sea-brine.

Some of the effects of its souse were peculiar. The blank page shown in the illustration when sent out bore a specification printed in the regular aniline duplicating ink. It did look tasty, we admit, and the lapping waves must have found it so, for they licked it off clean. This happened in several places throughout the pile of correspondence. Blue-prints were uninjured, but red-ink changes marked upon them had faded out to a light-pink blot, spread over the locality where the writing had been.

Hereafter we hope submarine and others will please note that, although our technical correspondence may be dry, we prefer it that way.

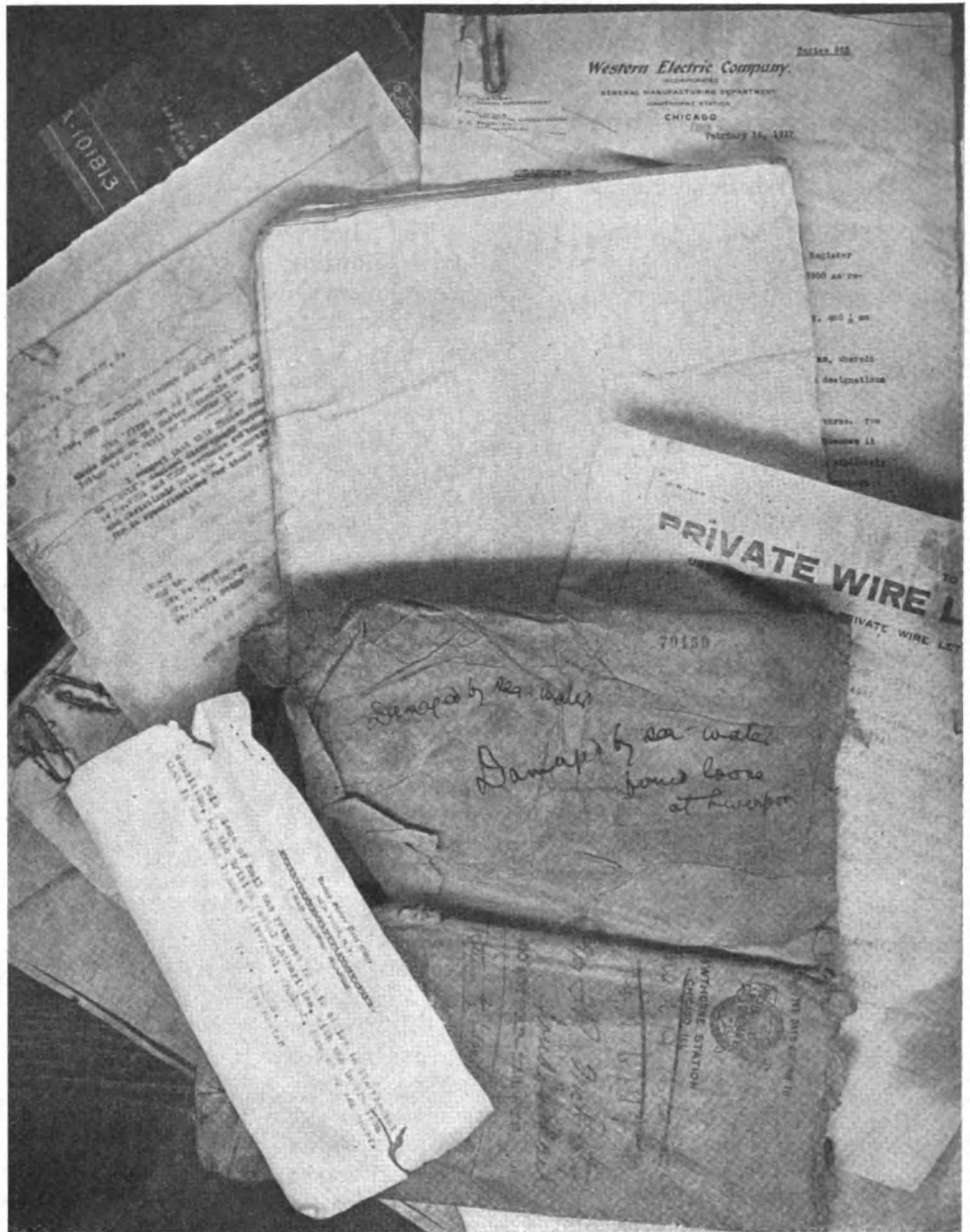

At the New Fairmont Exchange

Every once in a while, for a long time, the News has been getting some good contributions from Fairmont, West Virginia. Invariably they have been signed "E. C. Gatrall." Verse and prose—always from the Installers' standpoint—and it has been very welcome.

Now, as the magazine romps to press, in comes a picture from the same source which he tells us is "A Group of Installers at the New Exchange in Fairmont." But just who's who—who can tell? And which is E. C. Gatrall? It is asked to be known.



HAWTHORNE E. A. ATHLETICS



Industrial League Bowling



Industrial Bowling League Champions, 1916-17. STANDING, LEFT TO RIGHT—G. Fortner, F. Greinke, G. Rude. SITTING, LEFT TO RIGHT—Wm. Teichtler, F. Viduna. George Fortner is the individual champion

The Industrial Bowling League season was brought to a close May 10th with a banquet at the Sears, Roebuck Department of the Y. M. C. A. Our boys, again the league leaders, were presented with the winners' trophy by H. R. Isaacson, chairman of the league. Supt. F. W. Willard accepted the trophy in behalf of our team.

Besides capturing first place for the Western, our bowlers won six of the twelve individual prizes given by the league. G. Fortner bowled high game for the season—253; "Big Bill" Teichtler pulled down the high average for three games (222-199-202; average, 207 2/3); and in addition, four of our boys got prizes given for high season average for the first ten men, Fortner finishing first with 182 44/48, Teichtler second with 179 10/57, Grienke third with 176 1/57 and Rude eighth with 166 33/45. Veduna, our fifth man, finished eleventh.

Last season, also, our bowlers took first place in this league.

The teams this season finished in the following order:

First—Western Electric Company (Inc.).

Second—Chicago Screw Company.

Third—Sears, Roebuck & Company.

Fifth—Ward Baking Company.

Sixth—Heywood Bros. & Wakefield Co. (Did not finish the season.)

Commercial League Baseball

Playing against adverse conditions our team is not yet in the best possible form. Four practice games were played, and we were on the wrong end each time, one run being the difference between victory and defeat. Three of these games were played with the strong Fairbanks-Morse team of Beloit, Wis. The scores were 3-2, 2-1 and

7-6. At least two of these games would have been won by us if it had not been for lack of control by one of the three pitchers used by the manager to find out just what men were getting into condition.

On Saturday, May 5th, we beat the T. E. Wilson & Co. team at our park in our first official game of the season. The box score follows:

<i>Western Electric</i>	R.	H.	P. O.	A.	E.
Fox, rf.	2	2	0	0	0
Evans, ss.	1	0	1	5	0
Jamieson, 2b.	1	2	2	1	0
C. Kavanaugh, lf.	0	0	1	0	0
Fieme, 1b.	0	1	9	0	0
Swanson, cf.	0	0	2	0	0
Chouinard, 3b.	0	0	2	1	0
Rehor, c.	3	1	5	1	0
Cantwell, p.	0	1	2	0	1
Young, p.	0	0	0	0	0
Totals	7	7	24	8	1

<i>T. E. Wilson & Co.</i>	R.	H.	P. O.	A.	E.
Cross, cf.	0	2	1	0	0
L. Kavanaugh, ss.	1	1	0	2	1
De Lave, 3b.	1	0	0	3	0
Delaney, c.	0	0	1	2	0
Stock, 2b.	0	0	5	2	0
Hohm, rf.	0	0	1	0	0
Gorman, lf.	1	1	3	0	0
McNichols, 1b.	1	1	10	1	0
Doherty, p.	0	0	0	2	0
Totals	3	5	*21	12	1

*None out in eighth inning; game called by agreement.

Innings	1	2	3	4	5	6	7	8
Western Electric Co.	0	0	0	0	2	0	1	4-7
T. E. Wilson & Co.	0	2	1	0	0	0	0	0-3

Western Electric Tennis Team Wins Opening Match, 9-0

Our Commercial League Tennis team won its first match of the season by a score of 9 to 0. The details of the score are given below.

	<i>Western Electric</i>	Points	Points	<i>Commonwealth Edison</i>
Singles—	Latane	1	0	Howland
	Biggar	1	0	Benson
	Cook	1	0	Kollman
	Hess	1	0	Heitman
	Pratt	1	0	Parker
	Huscher	1	0	Schreiner
Doubles—	Latane-Biggar	1	0	Howland-Benson
	Pratt-Baldwin	1	0	Kollman-Heitman
	Cook-Huscher	1	0	Parker-Schreiner

The standing after the first match is as follows:

	Won	Lost	P. C.
Western Electric	9	0	1.000
Chicago Telephone	6	3	.667
Peoples Gas Company	3	6	.333
Sears-Roebuck	0	0	.000
Commonwealth Edison	0	9	.000

The tennis committee has decided to abolish the handicap and inter-department tournaments this year and substitute a class tournament. All tennis players in the Hawthorne Works are eligible for this tournament. The committee is dividing the entrants into classes, based on their known ability or their standing in previous tourna-

ments. The first prize in the highest class will probably be a gold medal, and it is expected that some additional prizes will be given.

Payroll Bowling League



The Payroll League Trophy

The Western Electric Payroll Bowling League rolled their final series April 9th, winding up in a three-cornered tie for first place.

A roll-off and tournament was held one week later, resulting in a victory for the Gang Piece-

work Section over the Office Roll Section by a narrow margin of three pins. The winners were presented with a beautiful silver loving cup donated by F. Kohout, of 3622 West 26th Street. The doubles tournament was won by P. J. Palka and J. A. Carroll with a total of 1150 pins. P. J. Palka duplicated his good work by winning the singles with a 594 score.

FINAL LEAGUE STANDING

	Won	Lost	P.C.
Gang Piece-work Section.....	35	26	.574
Weekly Roll Section.....	34	27	.557
Checking and Figuring Section.....	34	27	.557
Service Section	27	33	.450
Adjustment Section	27	33	.450
Records Section	25	35	.417

High Team Game—Records Section (592).

High Team Average Three Games—Service Section (546).

High Individual Game—Heitzman (234).

High Individual Average Three Games—Mudra (195).

High Grand Average—Palka (189).

Activities of the Hawthorne Club

THE only thing quieter than a chess or checkers match is a group of deaf-mute students giving their college yell. Yet if you have good eye-sight you can hear the report of one, so we are publishing below the results of the 1916-1917 playing season of the Hawthorne Club Chess and Checkers Section.

The first honors in chess this season go to H. Hokensen, one of the new men, who defeated J. M. Stahr, last year's champion, after playing off a tie with him. In checkers the leader is John Howe, Jr., who also holds the checkers championship of Illinois.

The Chess and Checkers Section numbers 193 active members. To accommodate all, several class tournaments were arranged, following preliminary matches to group players according to ability. The results in the various classes are given below:

PRIZE WINNERS—CHESS

CLASS "A"				Prize
Won	Lost	P.C.		
1. *Hokensen, H.	12	1	.923	Gold Medal
2. *Stahr, J. M.	12	1	.923	Gold Medal
3. Shallcross, J.	11	2	.846	Silver Medal
4. Weselak, C. F.	9	4	.692	Silver Medal
5. Apsit, C.	8	5	.615	Bronze Medal

*Hokensen and Stahr played an extra game to decide championship.

CLASS "B"				Prize
Won	Lost	P.C.		
1. Grosvenor, J. F.	8½	3½	.709	One copy "Freeborough's Chess Openings"
2. Boot, C. W.	8	4	.667	One year's subscription to American Chess Bulletin
3. Kunert	7½	4½	.625	Pocket Chess Board

CLASS "C"				Prize
Won	Lost	P.C.		
1. Hamblin, L. T.	9½	2½	.790	One year's subscription to American Chess Bulletin
2. Rassmussen, C. R. ..	8½	3½	.709	Pocket Chess Board
3. Stalknecht, G. R. ..	8½	3½	.709	Lasker's "Common Sense in Chess"

CLASS "D"				Prize
Won	Lost	P.C.		
1. Dunlap, H. E.	6	1	.857	Pocket Board
2. Vanselow, J. C.	6	1	.857	Lasker's "Common Sense in Chess"

CLASS "E"				Prize
Won	Lost	P.C.		
1. Kalina, O. J.	3	1	.750	Same as "D"
2. Jones, A. C.	2	2	.500	

CLASS "F"				Prize
Won	Lost	P.C.		
1. Rice, T. C.	7	0	1.000	Same as "D"
2. Fajrajal, J.	5	2	.715	

CHECKERS

CLASS "A"				Prize
Won	Lost	P.C.		
1. Howe, Jno., Jr.	55	9	.859	Gold Medal
2. Dvorak, F.	37	27	.578	Gold Medal
3. Walton, O. F.	35	29	.547	Silver Medal
4. Rada, F. J.	33	31	.516	Bronze Medal

CLASS "B"				Prize
Won	Lost	P.C.		
1. Raush, G.	52	20	.723	Call's "Vocabulary of Checkers"
2. Jacobson, B.	48	24	.666	Jordan's Pomeroy Match
3. Hamblin, L. T.	48	24	.666	Pocket Checker Board

CLASS "C"				Prize
Won	Lost	P.C.		
1. Moose, W.	40	24	.641	Checkers and Board
2. Gaul, B.	39	25	.609	Pocket Checker Board
3. Dupere, J.	39	25	.609	Call's "Literature of Checkers"

		CLASS "D"				
1.	Kristufek, C.	51	5	.910	Pocket Checker Board	
2.	Purcell, P.	39	17	.697	"Yates' Checker Player"	
		CLASS "E"				
1.	Cavan, C. A.	27	5	.844	} Same as "D"	
2.	Kozlowski, Walter.	17	15	.531		
		CLASS "F"				
1.	Pratt, D. F.	20	4	.833	} Same as "D"	
2.	Sommers, E. R.	14	10	.583		

	Won	Lost	Pct.
Chicago	39	9	.815
Kenwood	33	15	.687
Northwest	29	19	.603
Western Electric	25	23	.520
Sinai	24	24	.500
Federal	14	34	.292
Telephone	4	44	.083



H. Hokensen, Dept. 5058, Hawthorne Chess Champion

Our club finished fourth in the Chicago City Chess League, which is a good showing considering the strength of the teams engaged. Three of our men — Apsit, Harrington and Shallcross — qualified among the individual prize winners, all tying for eighth place with Howe and Nietzsche, of the Chicago Chess Club.

The standing of the league follows:

Nuts and Raisins to the Credit Men

The following letter, recently received by Mr. Bray, our Credit Manager at San Francisco, is self-explanatory:

"Please accept the enclosed three dollars in payment for an article which I appropriated from the stock of W. E. Co. for my own use some years ago. The enclosed money will fully pay for same and remove me from the last of my debts.

"Hoping this will be satisfactory, and believing honesty is the best policy, I remain,

"Yours truly,

"W. E. KID."



Our Oakland House

By C. L. Huyck, San Francisco Correspondent

Six miles from San Francisco, and separated from it by San Francisco Bay, is the city of Oakland and a chain of surrounding cities and towns, all of which we serve through our Oakland house. The photographs depict the personnel of the Western Electric Company, Oakland, and its new location—the third within ten years, owing to the exigencies of this fast-growing territory.

The new store, at 300 Harrison Street, provides about 5,000 square feet of floor space for its various activities. In the very heart of Oakland's wholesale district, and distant but a few blocks from the center of the retail district, the new City Hall, Oakland's fine modern hotel and the Auditorium, the location is extremely good. The territory comprises Oakland, with a population of 236,000, and nine other cities, with a total of 150,000 more.



From left to right—Messrs. Crowson, Martinez, Power, Zahniser and Rimassa.



The Oakland house is managed by E. A. Crowson, whose staff comprises: W. C. Martinez, office salesman; L. Rimassa, counter salesman; L. Zahniser, stockkeeper; F.



E. A. Crowson, Manager of the Oakland Store

Power, service and delivery, and John Haas, messenger, between San Francisco, Emeryville (where our shop, warehouse and cable yard are situated) and Oakland.

The territory is remarkably flourishing. Formerly considered a suburban city, Oakland has recently made skilful and generally successful efforts to acquire an industrial rank, and to attract outside plants by her rail and water convenience of location.



NEWS FROM HEADQUARTERS

Some Items of Interest from the General Departments



General Sales Department

W. A. Wolff, Correspondent
CAPTAIN KICK SALUTES YOU



We were fortunate enough to be able to take a photograph of our farm light plant expert, J. A. Kick, in his new regimentals just before he was summoned to Chicago to take up his duties on the staff of the Chief Signal Officer of that district.

You can plainly see that Captain Kick is not a bit scared, for there is a smile upon his otherwise stern lineaments. Any one who has seen service in the Philippines wouldn't be frightened at going to Chicago.

ON IMPROVING ONE'S MIND

Once when we were young and quite credulous, too,
And had plenty of knowledge to get,
We aimed to devour all the books that were writ
By men of success and who deigned to transmit
How all of their problems were met.

So a few years ago, we consulted the boss,
Who seemed to be pleased with our hunch,
And he said, "I've collected full many a tome
Just full of good lore; you can read 'em at home.
You'll find them a worth-your-while bunch."

We fell for it, brethren, and took them in turn;
We burned our Sunbeams each night.
Not a word did we miss—for we avidly read
All the worldly-wise things that these sages had said,
And for years we basked in their bright light.

But one day we sat back and started to think,
Which we should have done long years before,
And found out that our brain (if we may use the term)
Was beginning to turn like the so well-known worm
With this queer contradictory lore.

For it seemed A. B. climbed to success in one way;
While C. D. in another came through,
And everyone else had a different way
With which he had gained his much vaunted entrée
To the ranks of the men in "Who's Who."

We confess that we do not yet know any rules
That will hold true in more than one case,
So we'll keep right on drilling—mayhap e'er we die,
Our guess will be better than some other guy;
Then we'll write the book in his place.

—W. A. W.

According to a report from one of the eastern houses,
at least one city in the east is not suffering from want of
food or money, according to the following statement:
"The local banks are bulging with fat depositors' accounts."

—A. S. K.

THE RAMIFICATIONS OF A BIG CAMPAIGN

All sorts of things get into E. A. Hawkins' office these
days for use in connection with farm light plants. They
now have an electric churn reposing there. All that is
needed to make it complete is a cow to supply the milk.
Can anyone oblige?

DEMAND AND SUPPLY OR WHILE YOU WAIT

The time is 4:50;
We've ten minutes more
Before we dive out
Of the old office door.
Ye ed. tells us sweetly
He needs a short pome
To fill out. We've done it—
And now we go home.

—W. A. W.

General Merchandise Department

J. H. Hellweg, Correspondent

Gerard Swope, vice-president and general sales manager, pleasantly entertained the division heads of the General Merchandise Department and Telephone Sales Department at the Union League Club one evening during his recent visit to Chicago. This was the fifth annual affair of this kind.

W. O. Ramsburg, recently of the General Merchandise Department, has been transferred to New York to the chief stores manager's staff.

We have ordered an extension to our empty box conveyor, so that empty boxes may be transferred direct from cars to the mezzanine platform on the second floor with but one handling.

As an entertainer, F. Windt, of the foreign sales division, New York, is a real rip-snorer, and we can prove it. J. G. Van Kuyk, sub-director of the Netherlands East Indian government telephone department, relates with gusto how friend Windt took him to the Majestic one evening, on their recent trip to Hawthorne, and fell asleep before the entertainment was half over. Mr. Van Kuyk, being mercifully inclined, took him to the hotel and tucked him away carefully for the night.

The Inspiration of a Woman's Needs Produced this New Kind of a Sewing Machine



Keep it on the closet shelf



Carry it upstairs or down



Put it on any kind of a table



Connect to any light socket



Take it with you when you travel



Use it on the cool porch



Western Electric Portable Sewing Machine

THE ordinary foot-power sewing machine is a clumsy affair at best. You cannot easily move it around, so you must bring your work to it. As a piece of furniture it is no ornament, and it takes up a lot of room. And the woman who uses it pays dearly in a tired body and tired nerves.

Recognizing these defects, the designer of the Western Electric sewing machine made it portable. The heavy, unnecessary parts of the old-fashioned machine were eliminated. The new

outfit—sewing machine and motor complete—is not any larger than a typewriter.

The motor is built in as a part of the machine. There are no belts or attachments to bother with. You control the speed by a touch of your foot and you can run the machine for five hours on one and a half cents' worth of electricity. With a Western Electric 2-way Plug you can operate both the machine and a lamp from a single socket at the same time.

If your lighting company or electrical dealer cannot show you this new kind of sewing machine, write to the nearest office for Booklet No. 512-J.

Costs Only **\$35**

(\$37 West of the Rockies)

**WESTERN
ELECTRIC
COMPANY
Inc.**

Gentlemen:

Please send me Booklet No. 512-J, describing your portable electric sewing machine

WESTERN ELECTRIC COMPANY

INCORPORATED

New York	Atlanta	Pittsburgh	Chicago	Kansas City	Denver	San Francisco
Buffalo	Richmond	Cleveland	Milwaukee	St. Louis	Salt Lake City	Oakland
Newark	Savannah	Cincinnati	Indianapolis	Dallas	Omaha	Los Angeles
Philadelphia	Birmingham	Detroit	St. Paul	Minneapolis	Oklahoma City	Seattle
Boston	New Orleans				Houston	Portland

EQUIPMENT FOR EVERY ELECTRICAL NEED

Name _____

Address _____

enum

Western Electric

Vol. VI. No. 5 **News** July 1917



COPPER MINING IN SOUTH AMERICA

Fellner



“THE SUPREME TEST OF THE NATION HAS COME. WE MUST ALL SPEAK, ACT, AND SERVE TOGETHER.” — *Woodrow Wilson.*

“We shall spare neither efforts nor expense to meet the demands on us—first for military preparedness and next for the urgent commercial service.”

—THEODORE N. VAIL, *President American Telephone & Telegraph Co.*

THIS COMPANY has for some time been making extensive arrangements to meet all possible contingencies:

It has built additional telephone plant of all types, such as central office buildings, central office switchboards, cables, aerial lines and other equipment.

Its engineering force has developed substitutes to take the place of certain raw materials which it has been impossible to secure because of the European War.

It has sought and trained hundreds of new employees who are now taking their places in the system and assisting in furnishing telephone service to the public.

It has sought to gain the cooperation of the public by means of advertising campaigns, pointing out the correct use of the telephone, so that by closer cooperation between company and public better service might result.

IN THE PRESENT EMERGENCY there will be serious demands upon all telephone companies, no matter how well prepared, for an unprecedented amount of service for commercial needs and in the National Defense.

Your cooperation in the use of this service will help make it most effective.

NEW YORK TELEPHONE COMPANY

War Service

DEPENDENTS

IT IS expected that the United States Government will make provision for the dependent families of its soldiers and sailors, but such action has not yet been taken, and some employees of the Company who have dependents have been called into military and naval service and others will doubtless be called soon, and their pay from the Government will not be sufficient for the support of such dependents.

Pending action by the United States Government this company will provide temporary financial aid to dependents of employees who, with leave of absence from the Company for that purpose, either voluntarily or involuntarily have entered or do hereafter enter the military or naval service of the United States during the continuance of the present war, such aid to be subject to the following regulations:

The Employees' Benefit Fund Committee is authorized to make allowances to dependents of such employees in such amounts and for such periods as it may determine, according to the merits of each case and with due regard to the ability of such dependents to wholly or partially support themselves.

No allowances will be made to dependents of any employees while such employees are receiving full or part pay from the Company.

These regulations are to provide for the exigencies of the situation pending a more permanent plan which it is expected will be provided by the Nation or through a national fund, and all payments provided by these regulations may be terminated at any time at the option of the Company.

All payments under these regulations will be charged to the expenses of the Company and not against the Employees' Benefit Fund.



President.

June 28, 1917.

Electric WS
JULY, 1911
Climate O

Western Electric News

PUBLISHED ONCE A MONTH FOR THE EMPLOYEES



My Trip Through South America

By P. K. Condict, Foreign Sales Manager

THE Brazilian boat was scheduled to sail at daybreak Saturday, November 25th, but I found out just in time that it would be possible to spend Saturday morning at the office and get a tender from the pier in Brooklyn on Saturday noon, as the steamer was to lie down the harbor until that time. On the prospect of departing for a warmer climate, my charitable nature had gotten the better of me and I had given away my winter overcoat. As the day was the first cold one of the year, I had to depart for Brooklyn wrapped in a sweater, light-overcoat and mackintosh. While we waited on the pier, which has no counterpart anywhere in South America for its complete lack of equipment, including many floor and side boards, I wished, as the wind whistled around, that I had not been quite so charitable. I thought, also, as it approached two o'clock and we still stood in the cold and without food, that the referees' whistles were about to blow at the great football games and that if the ship had only been scheduled to sail at daybreak the following morning we would have been that much better off.

The *Vestris* was the name of the ship. It was a relief to find that all of my bundles and baggage, which had been put aboard the day before, were safely stowed away in the stateroom. We did not weigh anchor until dusk, as there had been rumors of a German submarine and raider off the port of New York in that morning's pa-

pers. As we went down the harbor, another British vessel and a French ship went out ahead of us and all three of us dropped our pilots off Sandy Hook and steamed out to sea with not a light showing.

The next morning the passengers were greatly surprised to discover by the sun that the ship was going in about the opposite direction to that which she should pursue and many opinions and suggestions were offered. For several days we seemed to be wandering around a bit, but all that the Captain would say was that he was somewhere in the Atlantic where he had never been before. After three or four days it began to get warmer but still all of the port holes and blinds were tightly closed when any lights were lighted, and the inside of the ship was consequently not a good place to stay.

As we neared the Equator, preparations were made for the usual ceremonies to be observed by those who had never crossed the line. I had crossed it in visiting Australia and consequently was relieved of anxiety regarding my part

in the ceremonies. On the eventful day a parade was started around the deck shortly after luncheon, for which a number of the passengers who were to assist in the rites had suitably bedecked themselves as relatives of Father Neptune or his old mariners. I should mention here that the *Vestris* had a very fine swimming pool erected forward on the deck, that is, fine when the Neptune ceremonies were not



A Night View of the Same Mine Shown on the Front Cover. By Night, Braden is a Great Flare of Electric Light

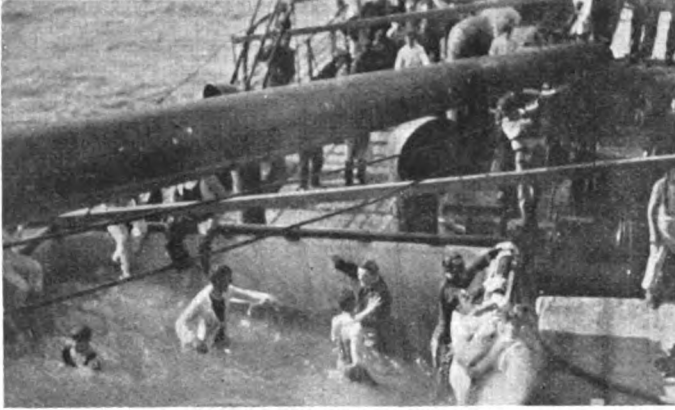

The "Rites" of Crossing the Equator

going on. The passengers who were to make their bows to Father Neptune and his Beautiful Daughter assembled in various costumes and were given peculiar looking medicines, often whitewashed, and finally thrown into the tank. The ceremonies ended by a number of the passengers, who had gone through them, deciding that it was high time that Father Neptune and his Beautiful Daughter, as well as the other performers of rites, should seek their native heath in the now discolored waters of the tank. Reserves had to be called to quell the riot. On another day we had a very excellent boxing match between two of the stewards, and frequently practice exhibitions of one sort or another were given by some members of a circus troop on their way to Buenos Aires.

Judging from the length of the days' runs, those who were well acquainted with the trip thought that we would take over three weeks to reach Bahia, our first port in Brazil, and we were all consequently surprised when it was announced that we would arrive at that port the following morning, after 14 days at sea. It seemed that the Captain had been making doubly sure by posting the runs considerably lower than were actually being attained.

Bahia is quite a pretty city. The business section is along the water front on a narrow strip, and just behind this rises a very steep hill, up which several cable roads run, at intervals, through the city. We had most of the day ashore and I was fortunate in being able to meet several of our friends. The city has a population of about 300,000, is served by a good network of electric street-cars, and has a modern telephone plant, although a great deal of difficulty has been experienced in operating it due to the great dampness of the climate,

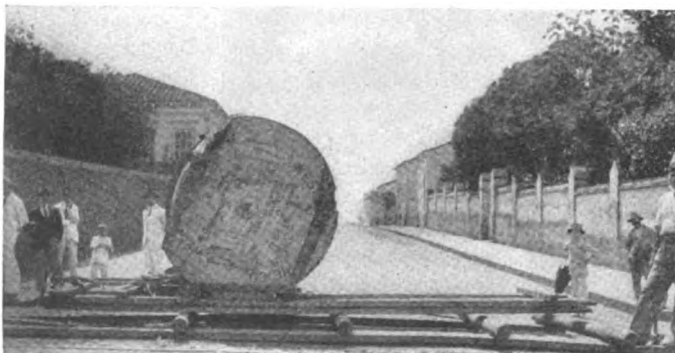

Cable Reels Encounter Some Rough Handling on Sea and Land

especially during the winter months. The climate of Bahia is distinctively warm.

We got back to the ship on time, but, as usual, she did not sail for two or three hours. While we were waiting in the harbor, it was interesting to note the number of German ships which had been lying there for two and a half years. One of the passengers told me that when news was received of the sinking of the *Lusitania* the German ships had all been decorated and bands started playing. An English captain in port saw it and was so annoyed that when he was ready to sail he had his Union Jack well displayed and ordered his band on deck, and then sailed in and out among the interned ships playing the well known air "All Dressed Up and No Place To Go"—and then passed out to sea.

Two days later we approached Rio de Janeiro, but unfortunately came into one of the most beautiful harbors in the world after dark and in a rain and fog, so that



Characteristic Distribution at a Typical Small Telephone Exchange in Brazil

it was impossible to see anything of the approach. As we anchored for the night inside the forts, the deck lights were turned on for the first time during the voyage and all of the cabin and salon port holes were allowed open. I was looking forward to my first sight of Rio, a city almost as large as Philadelphia, and was glad to be alongside the pier early in the morning. The docks at Rio are in distinct contrast to the one from which I had sailed somewhere in Brooklyn. There are railroad tracks running alongside the steamers, hydraulic traveling cranes and large warehouses just over the tracks for handling the great trade of the port. As we drove up the Avenida Central, which has been cut through the heart of the city within the past few years, I was not disappointed at all with my first views of the city. We passed the fine

Government and office buildings, the Opera House, one of the most beautiful in the world, and several parks, gay with tropical plants and flowers. Soon we turned up an avenue lined with royal palms and stopped at the Strangers' Hotel. A peculiar feature which I must mention here is that the pillows in Brazilian hotels are usually stuffed with sand. A sand pillow, after you become used to it, is very pleasant and is cooler than a soft pillow, but, when waking from the first night's rest on such a head-piece, you feel as though you had been in a rough sea and had been banging your head against the stateroom partition.

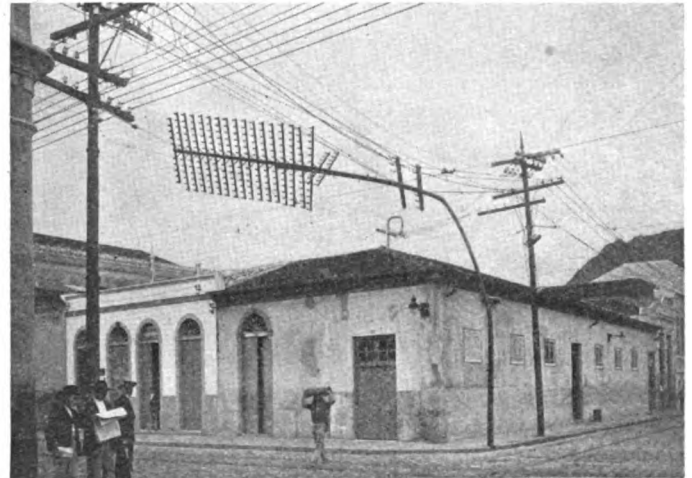

After a Typhoon at Santos, Brazil. Telephone Lines Are Now Carried Underground



South American Cities Touched on the Trip. Mr. Condict Crossed the Continent from Buenos Aires by Railroad Instead of Sailing Round the Horn—the Route Indicated by Dotted Line

During one of the first days that I spent in Rio I had the pleasure of taking the Tijuca Drive. I have heard of the Amalfi Drive in Italy and have taken beautiful drives in many parts of the world, but I doubt if there is anything that can compare in beauty with this drive from Rio. You go up the mountains behind the city on a road which goes through dense tropical foliage and every now and then, at the turns, views are obtained of the harbor stretching twenty miles inland to the foot of the Petropolis Mountains, then of Rio, and the next views will show you some beautiful fertile valleys lying two thousand feet below, and then again long stretches of the

Atlantic. Rio is one of the most delightful cities in the world in which to live.

The public utilities of the city are taken care of by the Rio de Janeiro Tramway, Light & Power Company, and very good service is maintained for tramways, telephones, light and gas. The telephone plant has been largely rebuilt during the last few years and with very good results. Power for the tramway and lighting service is generated at the hydroelectric plant of the company at Larges, which I had the pleasure of visiting.

I also made a trip from Rio to Bello Horizonte, the capital, and to Juiz de Fora, the leading commercial city of the State of Minas Geraes. We had fairly good trains to travel on, the greatest difficulty being experienced with their schedules, which always seemed to allow for trains arriving or leaving at 2 or 4 a. m. It was interesting to see something of the great inland country of Brazil and the possibilities for development which it presents.

A few days after reaching Rio I had a favorable opportunity of going to Sao Paulo. The railroad connecting the two cities is owned by the Government and a very good nightly train is operated. Sao Paulo is quite different from Rio, although only 200 miles distant. In the first place, it is situated at an altitude of about 2,000 feet, which makes the climate much more invigorating. One finds the people of the city more energetic than in Rio. Sao Paulo is a very large city, with a population approaching half a million, has splendid public buildings, parks and residential sections, and is a fine center for business. The richest part of Brazil is the State of Sao Paulo, which supplies the great bulk of the world's coffee. All of this trade clears through Sao Paulo and



A Private Railway on the Santos Dumont Fazenda in Brazil

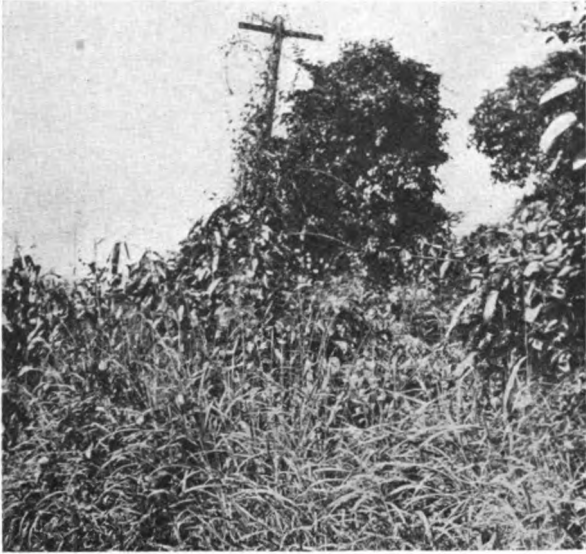

The Linemen in Brazil Have to Be Pretty Good Jungle-Plungers to Hold Their Jobs. If You Look Hard You Will See a Pole in There Among the Morning Glories

from there over the single railroad running down to the port of Santos, a road which is reported to be the wealthiest of any in the world.

I went up through the State of Sao Paulo with some of the people from the splendid telephone organization. We visited the large Santos Dumont coffee plantation, near the city of Riberao Preto. It was most interesting to see how the coffee is grown and prepared for market, and to ride about this vast estate over the private railroad, miles in length.

There are splendid cities all through the State (of from 10,000 to 75,000 population), which are generally supplied with electric light and telephone service, although the latter in many of the small towns leaves much to be desired. We visited one of these towns by automobile, but for some time there was a question whether we should be able to reach it, as we frequently stuck in the mud, and particularly when we got in so deep that the rear axle was resting on the middle of the road. But some of the coffee pickers came to our aid and we finally accomplished the journey, damaged only by the very red mud characteristic of that part of the country.

I spent Christmas in Sao Paulo and some friends very kindly invited me to their house. It was peculiar to be eating a Christmas dinner in weather more suitable,

according to our ideas, to the celebration of the Fourth of July, with the guests dressed in white and mopping their brows from the combined effect of the heat and eating too much turkey.

The regular liners running south to Montevideo and Buenos Aires were going at long and irregular intervals and it was impossible to find out just when one could be expected, so I decided to take a small coast boat leaving Rio on the 19th of January and stopping at a number of ports until I reached Rio Grande do Sul, where Mr. Mitchell and Mr. Burren, of our Buenos Aires house, had agreed to meet me. We spent a day or two there and at Pelotas, a little city on the great inland sea which extends from Rio Grande to Porto Alegre. After much sticking in the mud, the steamer arrived at Porto Alegre, the metropolis of Southern Brazil—a very progressive city, with much life in it, but one rarely visited by strangers in the country on account of its somewhat inaccessible position. We spent two days there. Then Mr. Mitchell and I started on the weekly express for the Uruguayan

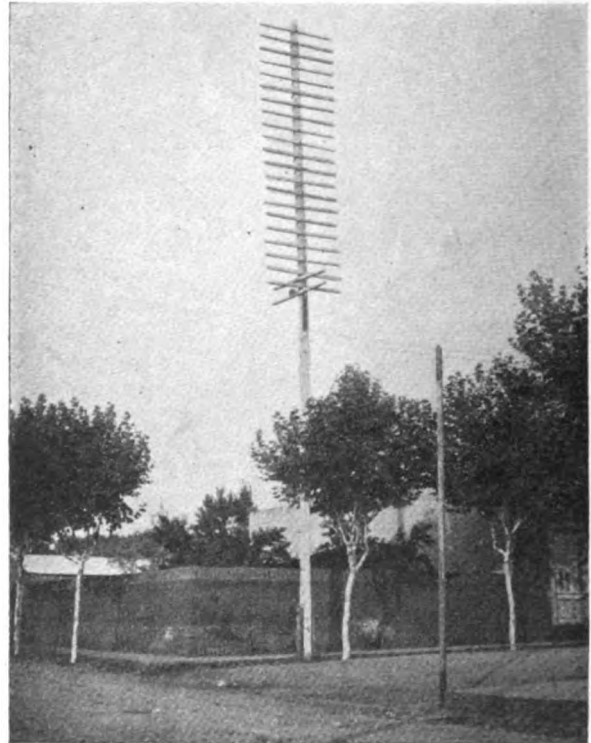

Pole Lines in Uruguay



A Section of the Magnificent Harbor of Buenos Aires



A Shipment of Western Electric Poles at Buenos Aires

border, leaving Mr. Burren behind. After a ride of 27 hours on a narrow gauge railroad in a sleeping car in which your knees either stuck into the berth above or out into the aisle to disturb passersby, and including a few stops while we got off to obtain some black beans and few other refreshments, we arrived at Santa Anna and quickly drove through the town, one-half of which is in Brazil and the other half in Uruguay, the other half being called Rivera. We had made careful inquiries and plans at Porto Alegre and felt confident of being able to pursue our journey immediately to Montevideo and were much disappointed to find that there was no train for 36 hours.

I have never seen it rain so hard as it did during our entire stay in Rivera, and it seemed as though every fly in the town had heard of our arrival and quickly seized the opportunity to enter our rooms and keep out of the



"Is the Track Clear?" W. E. Railway Telephones in South America (Chile)



Looking Up the Avenida de Mayo Toward the Capitol, Buenos Aires

wet. There were so many that one could neither work nor sleep, and the weather made going out almost impossible. I have seen the standard five gallon oil cans used for every conceivable purpose but the Hotel at Rivera is the only place where I have ever seen them used for shower baths. However, with a watering pot sprinkler on the bottom, and a string, they worked very well.

The Uruguayan train is of standard gauge and we had a very comfortable ride across the plains, for 20 hours, to Montevideo. Southern Brazil and Uruguay are great cattle raising districts and the business is increasing rapidly, one of the large American packing houses having recently decided to build a plant on the borders of the two countries.

Montevideo is a beautiful city, situated at the mouth of the River Plate. In summer particularly there is a great deal of social activity, for many Argentines come there for their vacations. There are many charming

(Continued on page 16)

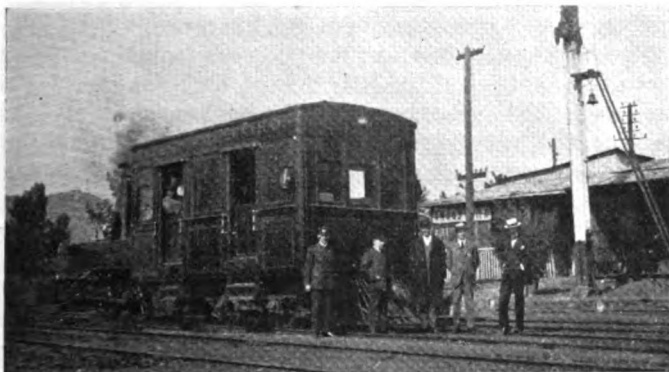

A Private Car on the State Railways of Chile

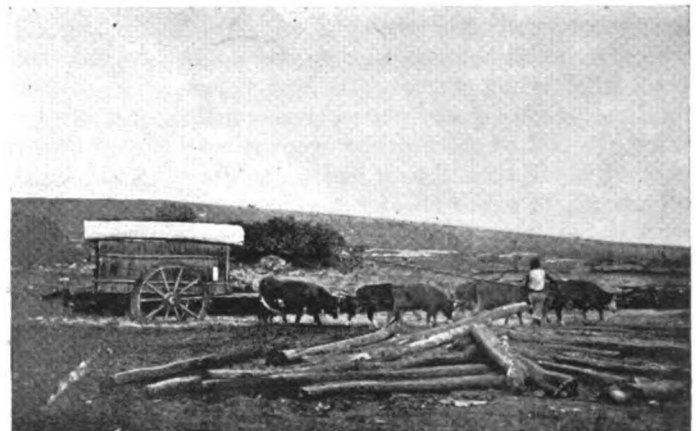

Transportation in the Interior Is Difficult

Putting New Apparatus in the Shops

What Hawthorne Does Before the Inventor's Model Becomes a Commercial Reality

"MAN wants but little here below" and the amateur is no exception. All he requires is a pencil, some paper and an audience.

"Here's a clever little device I just figured out," he remarks modestly, "for fixing watches that lose time. The trouble with the modern watch is that it has too soft a tick and, as every sleeper knows, a soft tick entices to rest. Hence these alleged time-keepers get lazier and lazier until finally they never get up with the sun, but always lag a lap or two behind.

"Now my cure for this fault is this simple little electric case-hardening furnace, which attaches to any electric light socket. When the case is hardened it of course becomes a more perfect resonator, which intensifies the sound of the tick. Deprived of its soft tick, the watch has no more tendency to go to sleep on the job, and it runs once more with all the pep of a new time-piece."

"But," objects someone, "what's to prevent your heat cracking a dozen or so of the jewels, warping the works and causing a hot time generally?"

"Oh, of course I haven't worked out all the details yet," the inventor puts in hastily, "but it will be easy enough to get around that."

More Than a Mere "Hunch"

However, the simple little matter of "getting around that" is the main difficulty in inventing—especially in perfecting an invention so that it can be manufactured and marketed at a reasonable price. To do that requires more than a mere "hunch" that will work out on paper. It requires a thorough knowledge of modern machinery and manufacturing processes, as well as the possibilities of raw materials. This is true even after the mechanical features have proved sound. The working model they show you when you buy your stock may work perfectly, yet the actual commercial output made under factory conditions may have more faults than your mother-in-law's daughter's husband.

When every part of a machine is made and assembled by an expert mechanic, the conditions are decidedly different from actual manufacturing conditions, where parts are made in separate departments by many different workmen and assembled in still other departments by operators who are not machinists, able to file a little off here and ream a little out there until everything works without binding. Even if assemblers were capable of doing this work, the cost of the finished product would often become prohibitive if such fitting had to be done. Besides this, all new parts required later by the users to replace worn ones would have to be altered to fit—a source of much annoyance and expense to the customer.

In Western Electric apparatus this question of strict interchangeability of parts and perfect operation is of paramount importance. If it's Western Electric it works—not part of the time or even most of the time, but all the time and every time. So the manufacturing engineering must be handled with as great care and skill as the designing engineering.

The NEWS for March, 1916, contained an article on the work of the engineering department in developing new apparatus. Our inventors not only complete the working models of their inventions, but they design these models with all possible regard to actual manufacturing possibilities. However, they naturally cannot have the intimate knowledge of manufacturing processes possessed by men who follow that work exclusively. Consequently, there remains a large amount of careful engineering to be done even after the model shop has turned out a satisfactory working model. This manufacturing engineering is done by factory specialists at Hawthorne. You may be interested to learn how they go about it.

When the working model, with drawings, reaches Hawthorne, it first goes to the apparatus drafting department. This is the department that makes shop drawings of all apparatus manufactured at Hawthorne. Its experts examine the new model and drawings to determine what standard parts can be utilized in its manufacture. Incidentally, they form a general idea as to the best and cheapest method of making the device.

How the Committee Goes About It

The results of their preliminary survey are then brought before a committee organized expressly to discuss new apparatus and to furnish cost estimates and comments on the design from a manufacturing standpoint. Besides representatives from the drafting department, this committee includes representatives of the cost estimating, layout piecework rates and inspection departments. The smoke inspector is not included and a man can light up any sort of a fumigator he likes, provided it does not cause him to indulge in pipe dreams, because any propounded scheme that sounds at all "phony" immediately draws the heavy artillery fire of the whole committee. In fact, that is the very object of the committee—to elicit ideas regarding the best and most economical way of making the new apparatus and to call forth suggestions of possible improvements in design, so that they can be discussed from various angles and proved good or bad before any manufacturing work is begun on the apparatus. The committee also discusses cost of manufacturing and probable savings that would result from changes in design. This preliminary survey of the situation helps all the departments in their subsequent work.

The layout department now proceeds to make a manufacturing analysis of the job; that is, they list in order all the operations necessary to make each part of the apparatus, the tool required for each operation, the machine it is to be used on, and certain other information, such as the probable yearly demand, the shop job number, etc., much of which is added to the preliminary analysis later.

This manufacturing layout, together with records of operators' rates, machine loadings, raw material costs, etc., furnishes the basis from which the cost estimating section computes the probable costs. For instance, if four holes are to be perforated in one operation on a No. 19 Bliss press, the cost can be readily computed from the number



Where They Thresh Out Their Problems in Earnest. A Meeting of the Manufacturing Analysis Committee

of parts the machine can perforate in an hour, the wages paid the operator and the "loading" on the machine. ("Loading" represents all costs of owning and running a machine, except operator's wages. For example, if a machine costs \$1,000 and wears out in two years it costs \$500 a year in depreciation, which figures down to a certain amount for each productive hour; it costs a certain amount each productive hour for rent of the space it occupies; it costs so much per hour for power to run it, etc. These and other similar factors determine the "loading.")

Now just stop and think a moment. Considering that the mere finishing process on some small part may require a dozen or more operations, you can form some idea of the vast amount of detail to be looked after and the large number of records that must be kept to determine the cost on just one part of a device that may contain hundreds.

The manufacturing layout, the inspection department's estimated cost of testing fixtures, gauges, etc., for checking the new apparatus, and the cost estimating section's figures are now reviewed by the committee with special reference to possible reductions in cost through changes of methods or changes of design. After the question has been threshed out thoroughly, the drafting department sends the estimated costs to the engineering department in New York, together with comments on the design. If a slight change in some part would reduce costs this change is suggested, together with the estimated cost of making the part in the proposed way.

Now our inventors do not have the usual "touchiness" of the tribe—the "hands off me che-ild" attitude. As a matter of fact, all of our inventions are usually composite affairs in the first place. Hence a few more fingers in the

pie arouse no jealousy, but on the contrary are welcomed. So the suggestions from the manufacturing branch are carefully considered. Sometimes there is a chance that the suggested change may interfere with the proper operation of the apparatus. In that case it is rejected, for above everything else all Western Electric apparatus must be reliable. In other cases the suggestions are accepted and incorporated in the manufacturing specifications for the apparatus, which is next completed and sent to Hawthorne.

At the same time, the general merchandise organization is notified that the design of the apparatus is completed. This organization is in one sense a wholesaler, acting between the manufacturing organization and the sales force. It now proceeds to issue a "manufacturing authorization" on the Shops. In other words, the wholesaler places an order on the factory for a supply of the new apparatus sufficient to meet the expected demand for three months. The authorization also states the probable demand for the year, and requests a promise of delivery on the first quarter's supply.

Making promises is one of the special privileges of the output branch of the manufacturing organization, and breaking them is one of its special perils—not that the output people fear the Recording Angel, for when the merchandise and sales organizations are done with them after a "fall-down" even a demon would be moved to pity.

So, to make the promise reasonably safe, it is first considered by the preparation period committee. Besides the representative of the output branch, this committee includes men from the apparatus drafting department, which will make all the official drawings and blueprints

of the apparatus; the layout department, which will issue orders for the tools required in making the apparatus and will also outline the manufacturing procedure of the Shops; the tool-designing department, which will design and make working drawings of the tools; and the tool-making department, which will actually make the tools.

"Well," says Drafting, "the best we can do on the drawings is 8-13."

"All right," says Layout. "We'll have our tool analysis done and the tool orders issued by 8-26."

"Eight-twenty-six—that will mean about 10-1 for the tool drawings," says Tool Design.

"Tools will be ready, then, by 1-15-'18," Tool-making decides.

Each of these departments knows from its tabulated schedules just what work it has ahead and when it can start on new work. The output branch, from its records and from its planning boards throughout the Shops, knows just when the factory departments can start work on the various parts and how long it will take to complete, inspect and assemble these parts. From all these data, the output men set a delivery date for the merchandise organization.

All of that is complicated enough at best. You can easily imagine what it means when the new apparatus is of enough importance to take precedence over much of the other new work, so that the entire schedule of all the departments involved must be rearranged.

But in any event, the apparatus drafting department must buckle in on those promised drawings and get them done by August 13 or else get a colored tack on the technical superintendent's schedule board, which keeps track of all the work under way in his various departments. A colored tack means a fall-down and a red-colored tack means an inexcusable fall-down. And if you reason a little further, you will probably come to the conclusion that too many red-colored tacks means a call-down. Which is quite correct.

The Manufacturing Analysis Committee

So the drafting department has those drawings ready by the 10th for good measure, and issues "unofficial prints" to all departments concerned. Thereupon, the manufacturing analysis committee gets together, looks over the prints and engineering models and discusses in detail the manufacturing processes involved and the kind of tools that will be required. This committee includes men from the apparatus drafting department, the tool designing department and the layout department (all of which we have referred to previously) and in addition representatives from the tool inspection department and the process inspection department. The tool inspection department must design various extremely accurate gauges to determine that the tools for making the new device are exactly right and will turn out parts within the limits specified on the blueprints. It must also design gauges for measuring the completed parts themselves, since every part is given a process inspection while in the making, in addition to the final inspection on the finished apparatus. That "final," by the way, is not entirely final, since a certain proportion of all the output is afterward subjected to a "check inspection" by the inspection branch to see that everybody along the line is doing a good job. Then, too,

the engineering inspection department checks up on a certain percentage of the apparatus after it is delivered to merchandise, ready for the customer, to see that all the engineering requirements are understood and properly met. If it's Western, it works!

But while we were digressing, the manufacturing analysis committee has been getting down to business. It discusses in detail the manufacture of each part of the apparatus, including the kind of tools needed to make it. Many are the abstruse points of manufacturing technique involved, and even the experts often disagree. And that is where the value of the committee comes in. Each man states his views and defends his way where a difference of opinion exists, and by the time the whole matter has been thoroughly discussed the best method has been found and accepted.

The ways are now thoroughly greased for actively launching the work. If necessary, the drawings are altered to include any slight changes in design agreed upon by the conference.

The Layout Department Begins

The layout department makes a complete tool analysis of the job; that is, they list all the tools that will be necessary for each part under the part number. They also fill in the identifying number of the tool drawing to be made by the tool-designing department, the number of the tool order to which the tool-making department will charge the expense of making the tool, and the estimated tool cost. The layout people also issue orders on the tool-designing and the tool-making departments to design and make the tools listed in the tool analysis. Gauges and other inspection apparatus are requisitioned from the inspection department, which does its own designing and drafting in its inspection investigation group and its tool-designing group, but has the tool-making department and the jobbing shops do much of the actual building of the testing equipment it designs.

The layout department also completes the manufacturing layout referred to previously, which outlines to the Shops exactly what operations they must perform on the part, together with the tool to be used and the kind of machine it is to be used on. The master layout does not go to the manufacturing departments, however. Instead, each gets layout cards listing only its own particular operations on the part.

But the Shops cannot use those layouts until they get the tools, so let's assume that the tool designers have completed their work and that the tool-makers have taken the mysterious pictures the designers produced and have translated them into tools. By the way, if you ever want to know exactly how big an inch is, visit the Hawthorne tool-room some time. Our tool-makers wouldn't have much respect for an inch that was just 32 thirty-seconds or even 64 sixty-fourths. With them it must be 10,000 ten-thousandths; for a ten-thousandth to a tool-maker looks as big as a sixpence to a Scotchman. "Within a hair" is not nearly close enough in their class of work.

Obviously, it requires some very close measuring devices to check up on tools that must be so extremely accurate. Our tool inspection department has them. They have devices so delicate that they could probably measure the amount a microbe's finger-nails grow over night if such

information were necessary to the health and well-being of Western Electric apparatus. It's a nimble ten-thousandth that gets away from the tool inspectors.

Their work completes the manufacturing preparations. Parts are now scheduled in the Shops and made under regular manufacturing conditions, the same as any of our apparatus—not a couple of dozen, to “try things out,” but thousands of them.

From this actual commercial output of parts, “tool-made samples” are assembled. They are given complete operating tests by the inspection investigation department. If the samples fail to operate correctly in every particular, the inspectors try to determine where the trouble is.

Their conclusions are later submitted to the cost and comments committee, where the matter is further discussed. If the trouble lies in the manufacturing it is eliminated at Hawthorne, but if it is due to faulty design it is submitted to the engineers, with any suggestions

the manufacturing organization may have for curing the faults.

If the apparatus works satisfactorily from the first there is, of course, no need of these latter steps. All that is necessary is to send tool-made samples to New York for a final approval.

It looks like a big job, doesn't it? It is a big job. You haven't heard even a fraction of the details. But it is a thoroughly organized job and it moves like clockwork, day after day, year in and year out. In a normal average year, between 3,000 and 4,000 new pieces of apparatus are put into the Hawthorne Shops. Since there are only 365 days in a year and since 52 of these are Sundays and some more are holidays and half-holidays, you can readily see that a day's work at Hawthorne is a day's work.

And you'll probably be perfectly agreeable if we call this a day's work, too.



Swinging Around That Circuit

Part III. The Western Electric in the Northwest, Where People Have Learned to “Do It Electrically”

WE who live in the East are accustomed to think of the “Pacific Coast” with little conception of its extent and the diversity of its scenery. Portland and Seattle are spoken of by the average New Yorker in much the same glib way as he rolls over his tongue St. Paul and Minneapolis. “Twin cities,” he says, “with a river or a lake or something in between them.”

From letters that come to our Coast houses from Hawthorne and houses on the Atlantic seaboard, it is perfectly evident that Portland and Seattle are considered to be within reach of each other by interurban trolley service, while to travel from either of them to San Francisco or its suburb, Los Angeles, you have a railroad trip something like that from New York to Boston or to Washington.

Well, it's all wrong Mr. Bunyan, it's all wrong! First of all, it's a short night's ride from Seattle down to Port-



Along the Southern Pacific Over the Mountains of Northern California. Arrow Points to a Tunnel Through Which Train Had Previously Passed



A Sharp Curve up in the Siskiyou Mountains. Snap-shot from the Observation Platform of a 12-Car Train Drawn by Two Mammoth Locomotives

land, a distance of 180 miles. Then one spends two nights and a day on the trip from Portland to San Francisco, although there is one train that covers the more than 700 miles in about thirty-three hours. And then, to get from San Francisco to Los Angeles, you ride from eight in the evening to ten o'clock the next morning.

In the handling of stock problems on the Coast somebody in the General Merchandise Department at Hawthorne is every now and then suggesting to San Francisco that a shortage of one thing or another can be easily and quickly met by asking Portland to “send down a few.” Some day that clerk is going to learn that drawing on the Portland or Seattle stock for San Francisco is like asking Chicago to fill its back orders by getting New York or Boston to “shoot along a few” out of their extra supply.

And what a diversity of country, climate, and industry along that 2,000 miles of coast line lying between the Pacific on the one hand and the Cascade and Sierra Nevada Mountain Ranges on the other! So much has been written of the geography of this coast country that we must pass this subject by. The one big surprise to me was to find that in order to get from Portland to San Francisco one has to climb just such a mountain range as in crossing the Great Divide of the Rockies. Indeed, the engineering achievements of that crossing, up 5,000 feet above sea level, seem to rank with those of the builders of the railroad through the Royal Gorge. The grades were as steep, the curves even sharper, the tunnels following one another in quick succession, so that altogether this ride south on the Shasta Route of the Southern Pacific over the Siskiyou Mountains was the more remarkable, because it was so little anticipated.



From Left to Right: Manager Colwell, Seattle; S. G. Ward; Mr. Mazheimer, of the Hughes Electric Heating Co.; F. N. Cooley, and W. E. Peters

At one point on a mountainside as we emerged from a tunnel, the trainman on the observation platform pointed down below us a couple of hundred feet to another tunnel through which the train had actually passed half an hour before, as it circled its way around the mountain to reach the summit. At another point, as we rounded a sharp curve, from the same rear platform, I got a snapshot of the front half of our train—of seven out of our fourteen cars. By the side of such engineering feats as were accomplished out there, the tunnels and horseshoe bends of our eastern railroads lose some of their glamour.

"Some" Climate

So much for the country. I found three different climates out there during March, and from the way the natives of the Northwest, San Francisco, and southern California each defended their own particular brand and took a fall out of the others, I dare say the differences are not limited to one month in the year.

In Portland and Seattle, so they told me in California, there are two seasons, August and the rainy season. Well, Portland was certainly running true to form when I was there, for it sure did pour on every one of the three days; while in Seattle the only thing that enabled me to get in an automobile ride one afternoon between showers was the standing which Irving Colwell, our manager there, has with the weather man. Yes, in Seattle, Colwell seems to know everybody and regulate most everything, so I'm not far off in crediting him, not alone with the ride in



Sales Manager John Ryan, of Portland, at the Wheel, and Frank Cooley, of Seattle, Posing for the "News" Camera

his car through Seattle's attractive boulevards and parks, but with the weather that made it possible. Over in Portland, John Ryan was ready to provide the ride—and it is said to be a wonderful one out on the Columbia Highway—but he couldn't regulate the weather like Colwell, and so I lost out.

Seattle has a wonderful harbor, and seems due for a tremendous development as a shipping port to the Orient and to Alaska. It is now the commercial centre in this country for Alaskan trade, and our house there does an extensive business with Alaska. The nearest I got to Alaska was lunching with Manager Colwell and some of his men at the Arctic Club, as shown in the accompanying snapshot; but some day readers of the News will have the opportunity to learn something of that remarkable territory from the pen of our own Mr. S. G. Ward, who took a three months' business trip up there last year, and has promised to tell us about it.

In Seattle

Seattle has a real metropolitan atmosphere which is accentuated when the visitor is shown to the top of a thirty-five story office building—the highest in the United States outside of New York. From it, one has a commanding view of the city itself, built like Rome on several hills; of Puget Sound, and the snow-capped Mount Ranier in the distance. It is from Mount Rainer, you remember, that the Company gets its fir crossarms.

Our business in Seattle was formerly conducted at two separate points, as in Denver and Salt Lake, but it is now centrally located in one building, recently reconstructed for us. It occupies a point close to the main streets of the city, and, at the same time, is within easy reach of the railroad terminals and wharves.

Here in the Northwest flourishes the lumber industry, while shipbuilding is coming to be of great importance, too. Our Seattle office does a large business in these and allied fields, and with the return of normal times in these lines, equipped as it is with such excellent facilities, our business seems destined to show a healthy increase.

"Very Unusual Weather"

If the effect of that Japanese current that we used to read about in our geographies was not as marked on the climate of Portland and Seattle as I had anticipated, let it be here set down, as it was carefully explained to me everywhere on the Pacific Coast, that "this is a very exceptional season." Indeed, when you travel out there, you must prepare for a species of what might be called

"climatic optimism." "We never have it as cold [substitute here 'wet,' 'rainy,' 'backward,' etc.] as it is this year" ["season," "month," "week," "day"]. When you find people opening up along that line, you may know that they are natives; and all natives out there suffer from "*climatis optimissimus*."

After my three day visit in Portland, I told John ("Johnny" really fits him better) Ryan, who is in charge of our sales at that point, that the only suggestion I could offer for increasing the business was to take on a line of umbrellas, raincoats, rubbers, and non-skid automobile chains. John says I ought to see Portland in June, and very likely John is right.

We operate a warehouse and sales department in Portland, reporting to Manager Colwell at Seattle. In both cities the electrical development is high, and here also are located the headquarters of several of the lighting syndicates that operate throughout Oregon and Washington. This is the territory of the hydro-electric plants that have so reduced the cost of manufacturing and distributing electricity. The Utah Power and Light Company, with headquarters at Salt Lake, was the first of these great systems with which I came into contact. It operates in 158 cities and towns in Utah, Colorado and Idaho, in a territory with a population of 260,000, in which it has 46,463 domestic customers who use a total of 59,344 electrical appliances. A development like that in the East is unheard of.

The hydro-electric light companies of the Northwest sell their current to householders at rates ranging from ten cents down to three cents per kilowatt hour; and the central stations that manufacture their electricity by steam generating plants compete actively with water power plants, both in their rates and their activity in pushing the sale of electrical devices.

The result has been a much higher electrical development, which is reflected in a corresponding activity among our houses in the sale of these appliances, particularly through these great syndicates. I heard of towns where every home is wired for electricity; of others where the sales of electric irons have equalled the number of homes using electric service. In Pomeroy, Washington, where the electric company has 545 customers, 143 of them have electric washing machines. No, they weren't all Western Electric; in fact, only a very few of them were

ours. But this gives you some idea of the possibilities of the electric appliance business. In Rupert, Idaho, the central station sells electric current for lighting at 7 cents per kilowatt hour, and at 2 cents per kilowatt hour for heating and cooking. Houses are actually being heated by electricity there and elsewhere in that territory.



Group of W. E. Boys of Our Portland Office. When the Sun Shines in Portland in March Everybody Smiles

Out there the general public has been "sold" on the idea of "doing it electrically," as a recent report in the N. E. L. A. Merchandising Committee proves. It estimates that the appliance purchase, per residence, in towns of 30,000 and less throughout the United States, is as follows:

Northern Atlantic States.....	\$.506
Southern States675
Middle Western States.....	.90
Southwestern States484
Rocky Mountain and Pacific States.....	1.744

It is such an environment as this that our Seattle and Portland houses work. Portland is a city of more than 200,000, and shares the bright future of Seattle. The comparative stagnation of the timber business, upon which it also depends, has arrested development during the past three or four years. In fact, from a real estate point of view, the city was overbuilt and is only just now catching up with itself. The boom in shipbuilding is benefitting it greatly, while it is, of course, the center of an extensive agricultural and fruit raising belt. Of the future of these two cities, and of our own business there, there can be no doubt.

Respect ? Slavish Admiration

To the Editor of the NEWS.

Here is a contribution from the correspondent's column of the *New York Globe*. The writer's tremendous respect for Electricity deserves to be commemorated in the pages of the NEWS. . Respectfully,

C. B. FOWLER, Circuit Laboratory.

"I am only expressing a layman's idea; it may be foolish, and, perhaps, who knows, it may contain the nucleus of something big. Let the engineers decide.

"Electricity is generative. Generate the currents of electricity on board a boat in sufficient force to establish an 'electric wall' so that when a torpedo shall come in contact with these electric currents it shall by contact explode. The current must, of course, be powerful enough to grant immunity to the boat when the torpedo explodes.

"Another idea, also through the use of electricity, is to create a powerful whirlpool or suction which will divert an approaching torpedo."

One Way of Measuring Speed

"Talk about the progress of electricity," Sales Manager H. L. Grant is quoted as saying recently, "I'll never forget the first authentic account of the wonderful new electric car which came to me when a boy. Living next door was a boyhood chum named Keith Reed. Keith's grandmother lived in Richmond, Virginia. After one of his visits to Richmond, Keith made himself a hero in our eyes with the following account of the speed of the new electric cars.

"Why," he said, "to show you how fast they go, I was standing on the corner waiting for the car. As far as I could see up and down the street there wasn't a car in sight. Then I spit and it went right in the car window."

Untechnical Talks on Technical Topics

SWITCHBOARD LAMPS

IN using your telephone to call central you either turn the crank at the side of the instrument and then put the receiver to your ear, or you just put the receiver to your ear without turning any crank. In either case you soon hear Central's "Number please?" and then you proceed with your conversation. When you're through talking, you hang up the receiver and turn the crank to tell central that you're done talking, or else, if there is no crank, you just "hang up." When you signal central by turning the crank, you operate a little device something like an electric door bell and that of course attracts her attention. But when you don't have any crank to turn and you just take the receiver off the hook or hang up, tiny electric lamps light up and thus convey your signal to the operator.

There are thousands and thousands of these little switchboard lamps in a large modern telephone exchange, each lamp about as big around as a lead pencil and a trifle less than an inch and three quarters long. Figure 1 is a full sized photograph of some of the most important Western Electric switchboard lamps. The right hand end

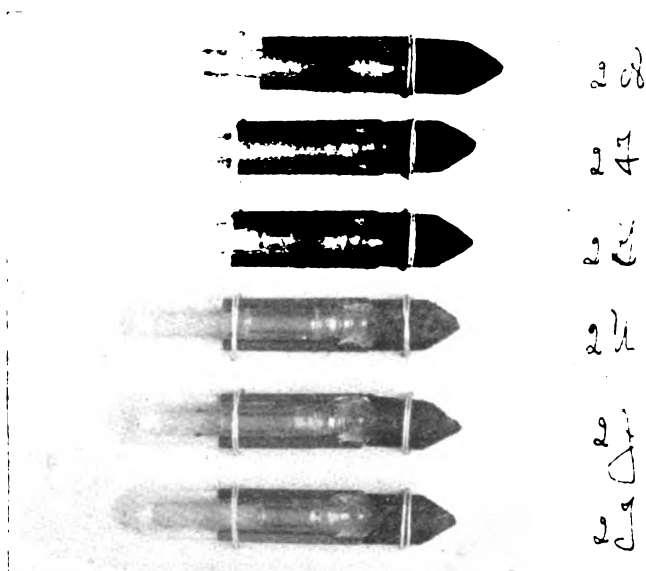

Figure 1

of these lamps is cut in a "V" shape. The lamps are pushed into the switchboard with the "V" shaped end first. This separates two contact springs which slide along the lamp as the lamp is pushed into the switchboard and finally make contact with two brass plates which you can see on each lamp in the photograph. The filament is inside of the lamp towards the left hand end. The electricity passing through this filament heats it red hot and thus makes a light which the operator can see.

Figure II is a photograph of one of these lamps in which the "V" shaped plug and brass plates have been removed. You can see in this picture, which is enlarged about three times, the wires at the right hand end of the bulb which originally made contact with the brass terminal plates and then you can see these same wires after they have passed

through the glass into the bulb and by tracing them towards the left hand end, you can see where the filament is joined to these wires by small drops of graphite paste. The all important part of a lamp of course, is the filament.

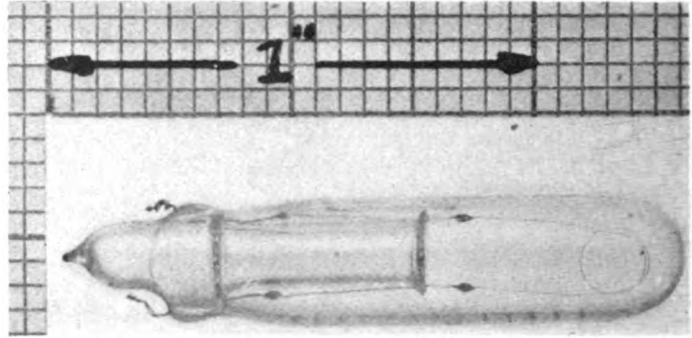

Figure II

In our lamps the filament is made of carbon. You all know what carbon looks like since we use it at home under the name of coal. Charcoal and coke are also other forms of carbon. When we put a shovelful of coal in the stove, the coal burns, heats our stove and finally all that is left is the ash. Since our filament is of carbon and since we do not wish it to burn up, we put it inside of a glass bulb, pump out all the air, then seal it up tight so that the filament cannot burn. Since the filament is sealed up inside of a glass bulb with absolutely no chance of getting at the filament to adjust it, great care must be used in the manufacture of our lamps so that when they go into service, they will not require any adjustment, for if anything goes wrong with a switchboard lamp in service, the only thing to do is to take it out, throw it away and put in a new lamp.

Getting Down to Fine Dimensions

The lamp department in Hawthorne makes more than 3,000,000 of these tiny lamps in a year. The filaments are made by dissolving very pure paper and then squirting this solution under pressure into very fine threads. These threads are dried, wound into the required shape and are then baked in gas heated furnaces until they turn black and are carbonized. These filaments are considerably smaller in diameter than a human hair. A pound of filaments would cost about \$30,000 and if they were placed end to end in one piece, a pound would be about 200 miles long. Since the filament is so small, we must be very careful to exhaust as much of the air as possible so that the filament will not burn up when we light the lamp. This exhausting is done by vacuum pumps which draw out practically all of the air which fills the lamp bulb. Of course some air remains in the lamp. The amount which is left, however, is only a very small fraction of the air which was originally in the bulb. Only about one part out of 1,500,000 parts of air originally in the bulb remains in the bulb when the exhaust of the lamp is completed.

We find that this small amount of air left behind in the bulb does not do any appreciable harm to the lamp. It is hard to realize when looking at one of these tiny combinations of glass, metal and wood that there are over eighty separate and distinct operations in its manufacture at each one of which something may occur which will cause unsatisfactory service.

The W. E. Co. makes many different kinds of lamps. Those shown in Figure I are the lamps for which there is most demand. The lamps appear outwardly of the same shape, the difference between lamps consisting in differences in lengths and diameters of filament, these dimensions being determined by the voltage and current under which the lamp must operate. These are determined by the conditions of the circuit and kind of service which the lamp is to perform. The 2U and 2G lamps are used as "line lamps." Line lamps are those which light up when you remove the receiver from the hook when first calling central. The line lamp burns until the operator has connected with your line and asks for your number. The line lamp goes out as soon as the operator plugs into your line.

In front of the operator in the key shelf are lamps known as supervisory lamps. It is by means of these lamps that the operator takes care of the connection for which you have asked. There are two supervisory lamps, indicating conditions on your call. One of these lamps indicates the condition at your end of the line, while the other lamp indicates the condition at the end of the line of the party whom you are calling. If your supervisory lamp is burning, it indicates that your receiver is on its hook and that you have completed your call. If the other supervisory lamp is burning, it indicates that the receiver of the party whom you are calling is hung up. Thus

when you first make your call and the operator has connected you with the party whom you are calling, before that party answers, the corresponding supervisory lamp will burn, and as soon as he answers your call, his supervisory lamp goes out. Whenever either of you hang up, the corresponding supervisory lamp lights up. When you re-call the operator by moving your receiver hook slowly up and down, the corresponding supervisory lamp lights and goes out, and thus attracts the attention of the operator.

If your line lamp burns out, then you will not be able to call central and will have to use another line. If a supervisory lamp burns out, the operator will not know when you have finished your call and you will be unable to call back the operator until she has taken down the cords of the previous connection. Consequently, the requirements for telephone lamps are that they shall be reliable and shall not burn out.

That great care is used in their manufacture is shown by the fact that the telephone companies consider lamps as part of their permanent equipment. That is to say, they do not consider that lamps in their switchboards will have to be renewed from time to time as cords and plugs have to be renewed. Our lamps are so well made that it would require about 500 years of normal use as line lamps before half of the lamps installed would fail. Since the life of a switchboard is about ten years, the lamps remaining in a switchboard at the end of this time are practically as good as new. Tests made in the Engineering Department show that our lamps are better than those made by any competitor since they will burn longer and will give a brighter signal than will the lamps of our competitors.



Mr. Sidley and Y. M. C. A. War Work Vice-President and General Counsel Has a Big Assignment



W. P. Sidley

W. P. Sidley, Vice-President, is a member of the Executive Committee of the National War Work Council of the Young Men's Christian Associations of the United States. This Council has the enthusiastic endorsement of the President and the military authorities of the country, and is in full charge of all forms of activity inside the concentration camps of

the country. This includes not only the religious work among the soldiers, but, very broadly, the means undertaken for their entertainment, including library and correspondence facilities, motion pictures, athletics, etc. The Council is working in co-operation with the "Morals

Committee," of which Raymond D. Fosdick is the head. The activities of the latter Committees are with conditions outside of the camp organizations.

The Council has organized this work on a geographical basis; and Mr. Sidley has been placed in charge of the Central Department, which includes fifteen States, lying between Kentucky and Canada; Pennsylvania and Colorado. Mr. Sidley states that he expects to see from one to five buildings located in every concentration camp in the Central District, with paid secretaries in each building.

The Young Men's Christian Association has already raised \$2,705,000, and has promised the Government a total of \$3,000,000 for this work this year. In all, there will probably be not less than 200 buildings in commission, and 1,200 men actively handling the work at these points.

Mr. Sidley's appointment to this prominent position follows several years' service as President of the Chicago Young Men's Christian Association. He is devoting the greater part of his time to the work, which involves large responsibilities.

HEARD IN THE SHOPS

ACTIVITIES OF THE MANUFACTURING DEPARTMENT AT HAWTHORNE

Who's Who at Hawthorne?



guess! Don't let us get your nan)—Fred Holdsworth, Hawthorne's chum.

Who trains a guileless packing box to go the pace that kills — and ere it stops, you bet your socks, it's loaded to the gills? Who ev'ry day saves work enough to keep a chap like you supplied with plenty of the stuff to last a year or two? Who goes forth, loaded up with ball, to hunt Ty Cobbs —(and, say, just nail your trophies down, that's all, when'er his speed-boys play)? Who is the Western's greatest fan—which sure is breezing some? (Aw,

Remembered

The News refrains from publishing most letters from old employees expressing appreciation of the treatment they have received from the Western Electric Company, not because the Company does not value these recognitions of its fair dealings, but because printing them might appear like claiming credit for policies that the Company follows as a matter of right, and therefore as a matter of course.

However, since the following letter only by inference classes as one of appreciation, and since the circumstances are interesting, we are publishing it in full:

Chicago, May 4, 1917.

Mr. C. E. Scribner.
Dear Sir:

You will no doubt be surprised to receive this letter, as it is just nineteen years this month since you saw me. Then I was in your employ as Annie M. Collins with Nellie Keefe, you will remember, the first two in the Lamp Department. I have tried to see you personally at the Clinton Street, also the Hawthorne offices, but failed in finding you at either place. Now my reason for writing you is this: I have a daughter just finished school and I would like very much to have her get a position at the Western. She has finished her business course, and as a beginner I feel if you would give her a letter or speak for her it would be of great advantage to her.

I hear from Nellie Keefe (now Mrs. Feltes) occasionally and we often speak of our time in the Lamp and Experimental Room.

Now, Mr. Scribner, I will bring my letter to a close. Hoping you will do what you can for me in this great favor, and that you are enjoying the best of health, I remain,

Mrs. H. A. Allenbrand (Annie M. Collins),
3343 Gladys Avenue.

Telephone: Kedzie 8599.

P. S.—Enclosed you will find an application in which she states the position desired.

What followed, even before the letter got to the Mr. Scribner it was intended for, is explained in the following reply:

Dear Mrs. Allenbrand:

Your letter of May 4th addressed to my son at Hawthorne, but which was, of course, intended for me, was forwarded to me. My son tells me that he talked with you on the telephone, and found a position for your daughter which he assures me will be one quite to her advantage.

Of course, I remember you very well, and the work which you and Miss Keefe did in connection with the very first development of switchboard lamps. That development and your part in it are a part of the history of modern telephone switchboard employment; and you are entitled to take some pride in having contributed what you did to the work.

It is an evidence of your interest in the Western Electric Company that you should wish your daughter to be employed by that Company, and I think, too, that it is a fine thing that one of the old employees of the Company should be so well remembered and should be able to come back to the Company with a request for a favor and have it granted. It is an evidence of very good standing on both sides.

If your husband is Henry A. Allenbrand, who was with the Company for so many years, I remember him very well, too, and wish you would tell him so.

Yours very truly,

C. E. Scribner.

Mrs. Allenbrand's daughter readily found a position in the stenographic section of the general merchandise department.

Burning Up the Cole

"Cap" Merrick called up the other day, the same "Cap" who figured in the dispatches recently on the occasion of his all-day vain search of New York for an honest man —(on a monument. There is a limit even to "Cap's" unsophistication). We beat all the big metropolitan dailies on that item, and were immensely gratified at the feat, but Merrick has been looking for a chance to get even with our informant ever since. The other day he thought he had it.

"Say," he announced, "I suppose you know Fred Holdsworth bought a new automobile—yes, a Cole. Well, as soon as he got it home he invited his wife to go for a little ride with him around the boulevards.

"Well, everything went all right until a cop held them up for smoking on the boulevards. Fred got out to take a look and found all the paint blistered off his rear hubs, and his brake-bands making 'Velvet Joe's' old jimmy-pipe look like an ad. for smokeless powder. It seems that Fred is so darned afraid the pesky machine will get frisky and run away with him that he drives with the emergency brake set."

It's the Best Word in the Language, After All

"High impedance" means something to an engineer, but nothing to a telegraph operator. We recently received a New York telegram with the subject, "High Independence Toll Equipment for Army Building." Yet in these days of the high cost of liberty, perhaps the operator is ordering the right things for the army, after all.

Our Wurst Accident

Here is one of our recent accident cases. We'll tell it to you without any comment, and see if you think the same as we do about it:

William Kietz, of Department 6631, was bitten by a dog which ran out of a sausage factory he was passing.

That's exactly the way we all look at it. Fido factories should be compelled to keep their raw material chained up.

Coats Off to the Flag!

Sherlock Holmes would perhaps discover that this picture was taken at 12:20 on June 5th, "Registration Day" for the selective draft. But would he also guess that it was taken in a drafting department? Ah! We had him there.

The decorations are the result of a voluntary war tax of four cents per capita imposed by the members of the plant drafting department upon themselves.

Many of the other departments throughout the works have large flags suspended from the ceilings in their sec-

tions. That is one of the ways the Hawthorne Westernites remind themselves that we must keep right on the job and on the jump for Uncle Sam.

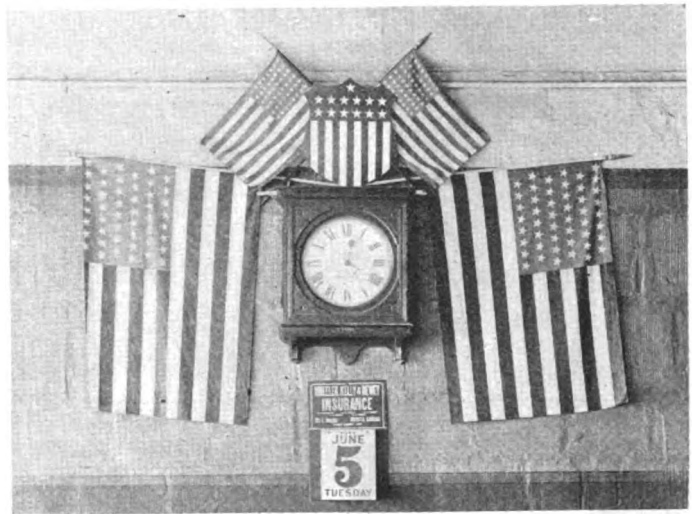

The Plant Drafting Department's Decorations

Among the Engineers

Is Somebody Spoofing Him?

C. P. Anderson, late of England, now of the Hawthorne engineers, is new to the gardening game, but he believes in doing his bit in spite of discouragements. And he has them! Recently he was telling one of the other men of

the trouble he was up against because his garden was full of worms. "Well, that's too bad," remarked his sympathetic hearer. "What sort of worms are they? Are they on the plants?" "No," said Anderson, "the plants haven't come up yet. These are long red worms right in the ground itself. I'll bet I've killed a thousand already."

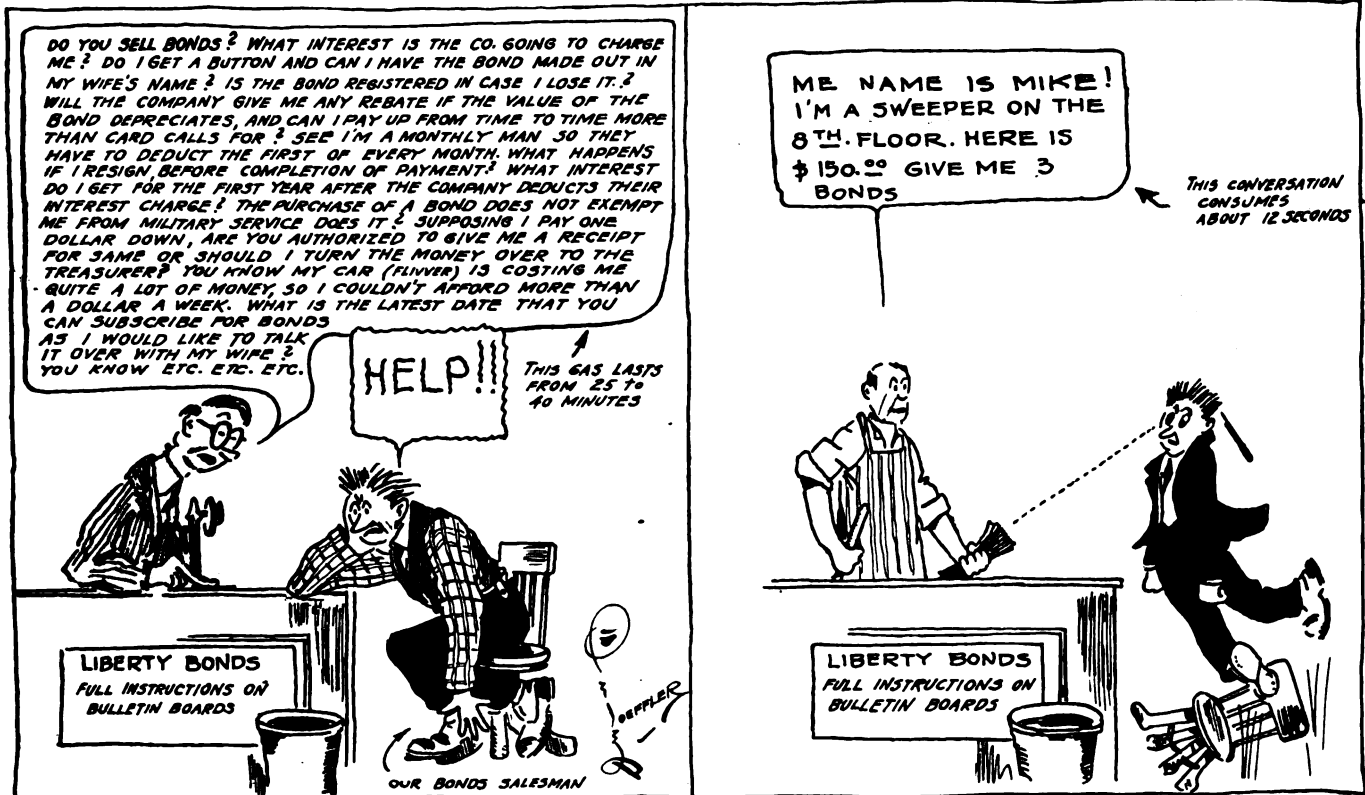

SELLING LIBERTY BONDS AT WEST STREET

My Trip Through South America

(Continued from page 5)

villas along the sea coast on the outskirts of the city. We only stayed in Montevideo for a day at this time, but came back later for several days to meet some of our friends and to consider the possibilities of improving business relations in Uruguay.

We Go to Buenos Aires

We had had little or no news while traveling in Southern Brazil and it was therefore a surprise upon arriving in Montevideo, on February 3, to see on the news boards that the United States had severed diplomatic relations with Germany. We went up the river to Buenos Aires that night on one of the fine steamers that run nightly between the two cities, the trip taking about 10 hours. The next day being Sunday, I was glad of an opportunity to look over my mail, which was the first I had received since leaving New York. In the evening

Plata, Cordoba and Rosario. Argentina has suffered during the last year from very severe droughts, causing great damage to the crops and the cattle, in which the great wealth of the country lies, and also from a locust pest. These locusts come from Brazil and are reported to arrive in such swarms as to literally eat up every green thing in the surrounding country. All of the population of the district affected is obligated to turn out and fight the swarms, but it is difficult at times to stop them.

That Twenty-six-Hour Ride

I left Buenos Aires on March 10th, Mr. Mitchell again accompanying me, for Chile. We had a 26-hour ride across the Argentine. The country is perfectly flat as far as the eye can see on both sides of the track and the land looked dry and parched as we passed over it. In fact, the dust was so bad the next morning that I awoke in a half suffocated condition. We reached Mendoza, a city at the foot of the Andes, late in the afternoon, and



THE BEAUTIFUL HARBOR OF RIO DE JANEIRO, BRAZIL. NEW YORK PHOTOGRAPHY

Mr. MacCrellish came for dinner and later we drove about the city to see some of its beauties.

Buenos Aires, a city almost as large as Chicago and with a climate somewhat similar to Atlanta, is certainly a splendid city, well provided with public buildings and beautiful parks. The harbor works are far famed and are well equipped to handle the enormous tonnage of the port. It is the largest city in South America—the population is close to two million—and is modern in every sense of the word, with its ample tramway service and underground railway. The electric light and telephone services are also very good, the plant of the United River Plate Telephone Company having been largely rebuilt during the last five years. Our Buenos Aires house is doing good work, and is well equipped with office and warehouse facilities. Altogether, I was in the Argentine about five weeks, making trips to La Plata, Mar del

had a chance to see this pretty town which has been built up as the center of a great wine producing section. For miles in all directions the land has been irrigated by the snow waters from the mountains and very fine grapes are grown. The Trans-Andean train left the next morning at six o'clock, connection being made with a through train from Buenos Aires.

To Chile

All of that day we spent traveling through the beautiful scenery of the Andes, in the afternoon starting the descent on the Chilean side, where the mountains are much steeper and the scenery even more grand and rugged. We arrived at Santiago about eleven o'clock.

Chile, as you know, is a very long and narrow country, more than twice as long as the State of California, extremely mountainous and with fertile valleys from Santi-

ago south. The Chileans are an active, progressive people, and, possibly due to their great coast line, have interested themselves more in maritime affairs than other South American peoples. The city of Santiago is beautifully situated in a valley almost surrounded at some little distance by the lofty snow-capped peaks of the Andes. Among the numerous interesting experiences which I had in Chile, I remember particularly an exhibition which was kindly arranged for us one night by the Chief Director of the Fire Department of Santiago. The personnel of this department is made up of many of the finest men in Chile, who give their services and subject themselves to call at any time of day or night, leaving their regular work as the fire alarm is sounded. I do not believe there is a department anywhere which could have its equipment at the scene of fire more quickly than the companies in Santiago, and when a modern installation is provided for signaling it will probably be one of the best services of its kind in the world.

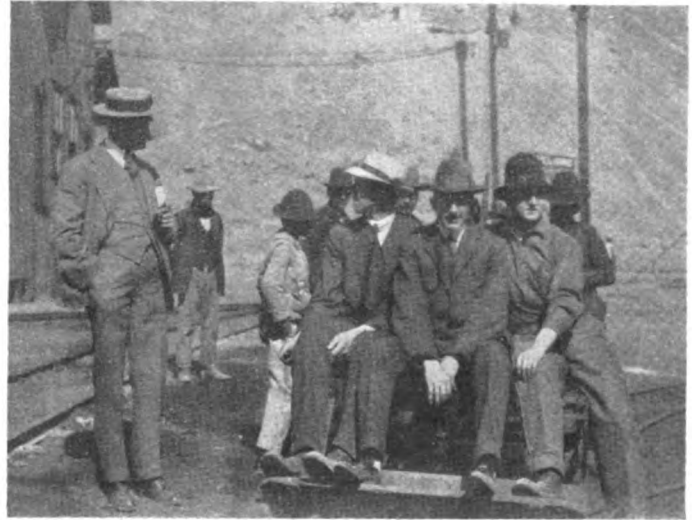

Coasting Down From the Braden Mines.



'S HAVE PRONOUNCED THIS ONE OF THE FINEST PANORAMA PICTURES EVER TAKEN

We spent an interesting day with some of the officials of the Chilean Government Railways in inspecting their telephone and telegraph lines, and on the way back they very kindly dropped us at Rancagua, where Mr. Mitchell and I had arranged to visit the Braden Copper Mines. It was quite an experience to go over their private railroad on a black night in an automobile car and have someone tell you that at a certain place we were just passing an engine had fallen off the embankment recently or at another place there was a 600-foot drop into the valley below.

Braden's Roller Coaster

We had a chance of seeing all of these places when we came down two days later on a hand car, under the expert guidance of the Chief Electrical Engineer, when, in spite

of his assurance that he was only coasting at half the rate he usually traveled, both Mr. Mitchell and I had a clear expectation of shooting hundreds of feet into space as we hit the various curves. We were shown all through the mines, the mill and the smelter, and it was a most interesting trip. You can see from this month's cover what part of the mine looks like, but you must realize that the mountains are quite bare of foliage on account of the sulphur fumes. In winter some of the little valleys are often buried deep under snow slides.

EDITORIAL NOTE—*This is the first installment of Mr. Condict's travelogue. The second and concluding article will appear in the August issue.*

AROUND THE CIRCUIT

GOSSIP GATHERED BY THE DISTRIBUTING HOUSE CORRESPONDENTS

Dallas

S. Zercher, Correspondent

C. K. Lawson, formerly Regimental Supply Sergeant, 4th Texas Infantry, has received a commission as 2d Lieutenant 1st Texas Cavalry. Mr. Lawson's record was published in the June News.

The Western Electric Dallas Educational Club has been formed by our shop employees. The fundamentals of the theory of electricity are studied, the discussion being led by a member of the club. Three meetings are held a week. More "Dallas Stuff."

Observe the picture of a Bulletin issued by Dallas and one issued by the General Dept. Ross D. Cummings says "He that tooteth not his own horn, the same it shall not be tooted." Because we were not given credit for subject matter that was copied outright we are taking this method of blowing our horn.

Appendix to C. S. S. Calendar
May 28, 1917
Dallas stuff

Western Electric Company

CORRESPONDENCE
MANUAL.

LESSONS IN METHODS

CORRESPONDENCE



December Twenty-six, Houston Edition.

Dallas stuff

DALLAS

HOUSTON

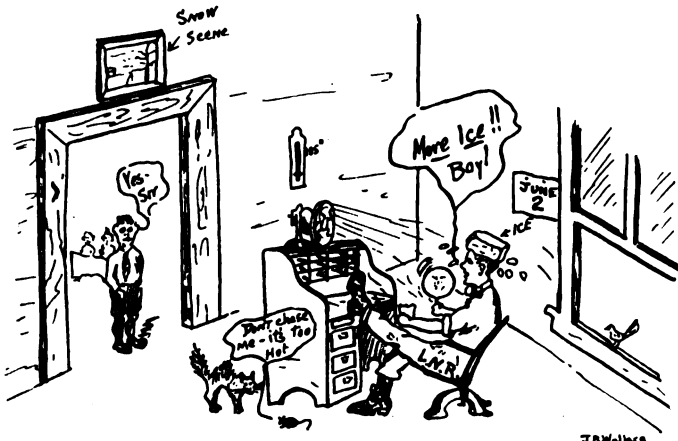

The accompanying cartoon of Mr. L. N. Rider, Acting Sales Manager, is true to life. A special committee has been appointed to find out what to do with him when summer comes.

San Francisco

C. L. Huyck, Correspondent
OUR FIRST ANNUAL PICNIC

With several freshly-shaved dictatype records tucked away in his head, on which to record picnic impressions, your correspondent hit Pinehurst on May 19th. There he met a large white-silk committee-badge, over which beamed the enthusiastic features of Chairman Binkley. "Glad you've come," said Binkley, "And now get busy. Circulate yourself; mix with the crowd and grab off

something good for the NEWS. It's all around you; just wade in and get it."

Mr. Binkley's advice reminded us of the late Montgomery's tip to Fred Stone in "The Old Town." They are supposed to be joint owners of a one-horse circus, and their tight-rope and trapeze artist is missing. "It'll have to be you, Fred," says Montgomery to his partner. "Me?" asks Fred, in consternation; "Why, I've never done it in my life." "Get up there and swing off," returns the inexorable Montgomery; "Haven't you ever seen the other fellow do it?"

Well, we could see the picnic all right, but whether that epoch-making day can be adequately set down on mere ink and paper is another matter. There were races, and insulator juggling, and a tug-of-war, and monumental eats, and dancing, and baseball, and outrageous flirting (of course) and dozens of cute kiddies, and costumes only to be described by the society editor, and an all-hands-around at the Redwood Inn that can't be described at all.

We migrated 700 strong, in our special train, leaving the San Francisco, Emeryville and Oakland establishments as populous as one-man submarines. All branches of the service, from manager down to the humble specialist, were represented.

Now, ever since the time that Mr. Leggett, perusing one of our contributions as a member of the News board, thought that we were trying to unload a corner lot, somewhere in California, we have fought rather shy of men-

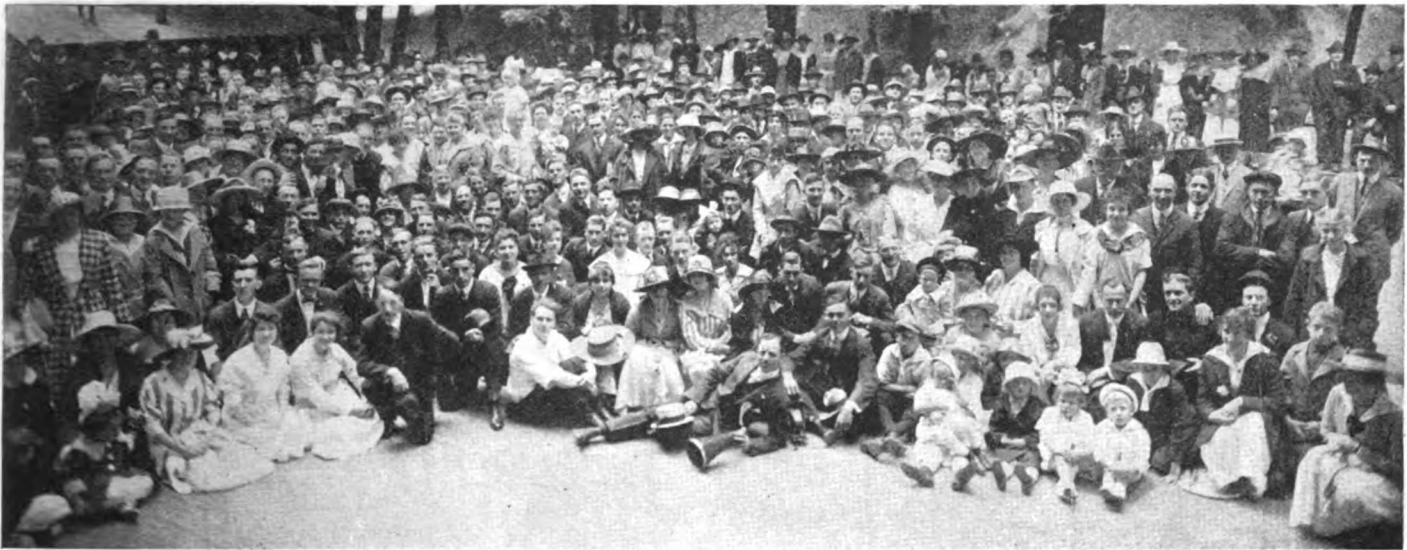

How They Lined Up at the San Francisco-Emeryville Picnic

tioning climate or scenery. Suffice it to say that Pinehurst is tucked away in a warm little pocket among the hills back of Oakland, and is well provided with benches, tables, sody-pop, shade-trees, a dancing floor and other necessities of the proper picnic landscape de luxe. The capable committee in charge promptly staged their set program, beginning with a series of races for juvenile contestants, who tottered, scampered, fluttered or sprinted according to their respective age and sex.

That splendid committee provided hot coffee and ice-cream to supplement our full-dinner-pails, and then came an afternoon of dancing, the floor being cleared now and then for the remaining contests. Miss M. Freitas' technique won the insulator race, where those who didn't slip on the floor either couldn't get the insulator into the spoon or couldn't keep it there. Mrs. Ross won the nail-driving contest after a merry clatter, in which Misses Hendricksen and Bordenave fortunately smashed their thumbs and were consoled by "Handsome Red" Dryer.

Up to the tug-of-war Emeryville and San Francisco had run very evenly in the matter of points scored, but San Francisco won this.

St. Louis

A. C. Cornell, Correspondent



George L. Delany

We believe that the first Western Electric boy to go to the front from the Middle West was George L. Delany, who was employed as Storage Battery Specialist. He left St. Louis on May 17th as a member of Base Hospital Unit No. 21, and sailed for London on the afternoon of May 19th from New York. Base Hospital Unit No. 21 is composed of a number

of the most prominent doctors in St. Louis on the Barnes Hospital Staff, and in addition a number of fine young

fellows for non-professional work connected with the Hospital.

The office and sales force gave Mr. Delany a farewell dinner at the Mercantile Club, at which there were about thirty-five present, and presented him with a practical keepsake in the form of a wrist-watch. We have received a cablegram from him, sent from the American Base Hospital at London, reading "Everything fine."

We have a large number of our employees enrolled in the National Guard; also in the Navy and Radio Service of the United States Government, who have left us in the past few weeks to go to their respective stations. Among these is R. C. Kendall, First Sergeant of Company "D" of the First National Guard of Missouri. He also served on the Border during the Mexican trouble.



R. C. Kendall

The Convention of the Associated Advertising Clubs of the World was held in St. Louis, June 3rd to 7th, inclusive. Among many other interesting things arranged for the delegates was a parade of all of the representatives from the various States and Canada, and also a night parade. In this night parade were illuminated floats representing various advertised products. Reproduced here is the float of the Union Electric Light & Power Company of St. Louis, on which are shown the Western Electric Washer and the Western Electric-Hughes Range. This float is entitled "The Matchless Kitchen."

Salt Lake City

In a recent efficiency campaign for time saving in the office we had occasion to question one of our new employees for not using a stairway from the office to the

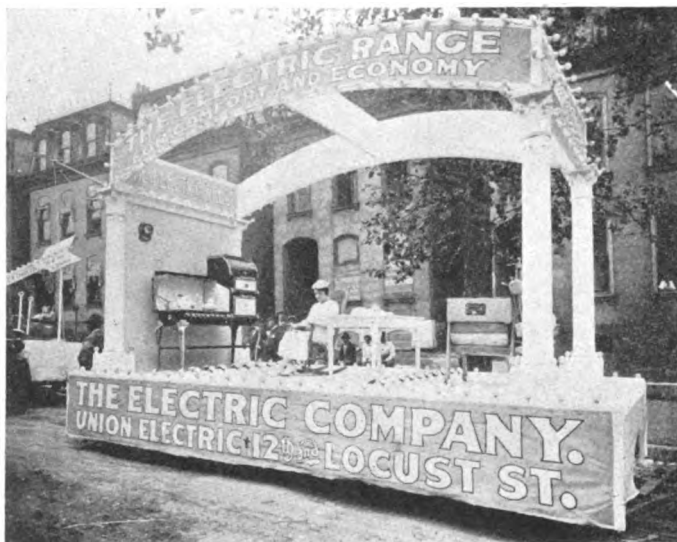

Western Electric Equipment on a Float in the Parade of the Advertising Folks at St. Louis Last Month

basement rather than going the length of the store and down the back stairs, so he led us to the door upon which had been posted a notice, "This door positively must be kept closed." It is certainly evident that our people believe in signs.

Cincinnati

D. E. Smith, Correspondent

Are there any other houses that can boast of every single one of its employees having backyard gardens? We can.

On May 26th the Hawthorne Baseball Club came to Cincinnati to play Norwood, the semi-pro. champions of the world. A good game was played, but our boys lost by a score of 4 to 2. The Hawthorne boys were urged on by the constant "rooting" of the Cincinnati boys. Norwood is a great team, and we made a formidable showing against them.



Jake and Henry are two names that do not usually hitch, but here we have perfect harmony together with a load of Brascolites. It can be plainly seen that the Henry is not overloaded because of the "Light Fixtures."

Pittsburgh

I. B. Stafford, Correspondent

"A BLESSING IN DISGUISE."

Our local speed artist and salesman, Charley McClary, had his life saved. Someone stole his "FORD." In it was

a good raincoat and his job (a Western Electric Catalog, which he claims was right up-to-date). He does not mind the "FORD" so much, but he has Pinkerton after the catalog so that he can prove to us that it was filed right up-to-date.

New York

D. Broadhurst, Correspondent

"EVERY HOUR ON THE HOUR; YOUR WATCH IS YOUR TIMETABLE."



Old Bill Hendry says if you feel so bad about it he'll buy you a new elevator.—Ed.

Do you think the engineer who discovered the system of elevator efficiency used at 463 West Street could be induced to publish timetable folders for each floor? Something on the order of the folders used by some of our railroads for suburban service.

"THE JOYS OF A CREDIT MAN"

Somewhere in N. Y.
May 22, 1917.

Western Electric Company,
New York City.

Attention of Credit Department.

My dear Sirs:

Replying to your inquiry of the 18th (S50-HPL) regarding payment of bill of twenty dollars, I beg to say that the bill will be paid some time soon. We are having a dance in a few days, and if we do not make enough money, I shall go out for private subscriptions that have been promised.

Hoping to straighten out our account in a few days, I am,
Very truly yours,

How would Dun or Bradstreet classify this risk?

A lady came into the office the other day and asked for the man who had demonstrated a washing machine to her the day before. She could not recall the name, but described the demonstrator as being tall, very good looking, and with beautiful light curly hair. Being a bright boy, Tommy's first thought was our very own Guilfoyle. Of course, he was right. J. V. G. is still blushing.

In his eagerness to get back to the office on "Registration Tuesday," "Comedian" Tom Craig thoughtlessly flashed a strange blue card. Pat being too wise to let anything like that go by, challenged the claims expert, wanting to know "Phwat wud ye be afther callin' thoat?" A bright idea struck T. C. "Oh, that's my ticket to France."

MONTHLY LETTER OF BUSINESS CONDITIONS IN CONNECTICUT

New Haven,

Sunday, June 3, 1917.

OUR SLOGAN: "Beat Buffalo! Nail Newark!"

Dear Parent:

Have received your letter of yesterday enclosing instructions on: Liberty Loan subscriptions; price advances on our 7,642 stock items, beginning with annunciators and ending with zines; applications for leave of absence for military service; 17 manufacturer's representatives who are to travel with our two salesmen next week; salesmen's automobile reports; 21 new specialties, including the wonderful Electric Fly Swatter; expense and investment statements, questions and comments; 53 requests for financial statements from prospective illuminated flag button dealers; 13 medical examination report cards; consigned motor stock; inventory cards, etc.

Will answer you on all points in detail when our office force gets back from spending Sunday with his girl in New York. I am otherwise engaged, writing an article for the NEWS.

Your loving progeny,

SUBBIE.

P. S.—When will you send pay roll check for last week?
S.

F. S. de Gruchy and F. R. Ewing are the latest members of the local sales organization.

W. G. Robinson, of our Telephone Service and Claims Division, was the guest of honor at a dinner and theater party given by "The Uno Club" of the New York Telephone Claims Department on March 10th.

Is that so!—Ed.

TO P. L. T.

Lives of salesmen all remind us
That we will, if we are wise,
Go and sell socket devices,
For they're all he'll advertise.

A SALESMAN'S PLAINT.

I learned to run a cleaner,
A female job for me—
Then they sprung a washer
Against my earnest plea.
Now I thread a needle
And wonder if I'll be
Sewing shirts for soldiers,
And known no more as "he."

The team Price & Burke, of Newark, has become quite expert in repairing automobiles and Fords for strange young ladies whose machines become stalled along the road.

Just the other day they returned from one of their emergency runs near Paterson. Mr. Price's hands were covered with engine grease. Mr. Burke's were spotless. What part of the breakdown did Mr. Burke take care of?

H. M. B.

Yes, we have heroes, too. Mr. N. C. Jones, of our Buffalo branch, is the latest.

We have this report from Mr. G. W. Tabb:

"I noticed in the Buffalo paper the other day that the hotel at Hornell had burned and that all of the occupants were obliged to flee in their night clothes. Remembering that Mr. Jones was due in Hornell that night, I called him up the next morning and asked him if he was in the fire. He advised me that he got out all right, but found there were some ladies still in the building, so went back and rescued them, with the result that he got pretty well choked up with smoke. However, quick application of a No. 11 Vacuum Cleaner removed the smoke and put him in good condition once more as an electrical salesman."

Congratulations, Newark, Buffalo and New Haven—all three in the same issue.

Seattle

Jo Sorenson, Correspondent

Apropos of the reference, in P. L. Thomson's article, to the widespread use of electricity in the Northwest, behold this modest home thoroughly equipped with electrical devices. It is the home of Mr. V. V. Vercoe, Manager of the

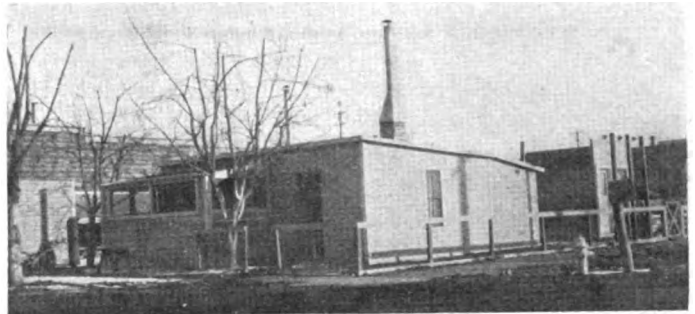

Pacific Power and Light Company of Sunnyside, Washington. In it are 1 No. 50 Hughes' Range, 1 750-watt Water Heater, 1 Western Electric Washer, 1 Western Electric Beauty Iron, Percolator, Toaster, etc. In the shop is a 3-h.p. motor with which this enterprising and wide-awake "Do It Electrically" booster drives a lathe and other apparatus.

Our representative, Mr. Peters, who sent us the snapshot, evidently believes you should first sell the central station manager.

The latest member of our organization to annex a new title is our congenial James J. O'Reilly. At a recent meeting of the Electrical Credit Association of the Pacific Coast, with offices at San Francisco, California, he was elected third vice-president.

Omaha

M. A. Buehler, Correspondent

We exhibit here an exceptionally good picture which we trust you will surely publish, Mr. Editor, for it took your correspondent some two or three weeks' time to persuade these girls to have their picture taken in their baseball suits. We are particularly proud of these ladies, for they are the star battery in the Girls' League here in Omaha—to be exact, they are Miss Edna Aitkenhead and Miss Frances Ortman, pitcher and catcher, respectively, of the Fontenelle Girls' Omaha League Baseball Team.



Omaha's Girl Battery

Misses Aitkenhead and Ortman are stenographers in the Omaha office. Now we suspect we know why so many letters were written from Omaha by the visitors at the last Sales Conference.—Ed.

Philadelphia

L. R. Browne, Correspondent

In the June issue of the News Chicago asks what was the best feature in the May News outside of the Chicago column. So far as we can ascertain, it was almost any place in the issue outside of the Chicago column. That's where the best features are usually found, according to our observation.

Holy smokes, also shades of slaughtered swine! Has Chicago just awakened to the fact that the list of phrases too frequently used in correspondence are taboo, bad English and obsolete?

It was our assumption heretofore that the progressive city by the Lake was in the van in new movements. A ban was put on these things in most places shortly after the conclusion of peace at the end of the Civil War. Chicago, dear, what has detained you?

Mr. Chairman, we arise to a point of order. It has been our distinct understanding for a long time that jokes and stories on the well-known vehicle so frequently seen throughout our glorious country were taboo. What sort of a bribe did Pittsburgh come through with in order to get by in the June issue? Besides, the several millions or so of these stories which reach us in the ordinary course of business, we have made up a few ourselves, but have never had the courage to put them up to the censor. Are the bars down? We ask to know.

For the benefit of the Gentleman from Philadelphia the Chair will repeat that "A joke, if it is good—anything, in fact, if it is interesting and has the W. E. Punch, 'goes' in this magazine."—Ed.

We extend our heartiest sympathy to Denver for the loss of the \$4.44 disallowed by —. We have all been victims of the laws and the profits.

Two or three hundred people have asked us if free verse is acceptable to our esteemed editors. We should like to be in a position to advise them. We can supply enough from here to fill double the space in the News, if that sort of literature can be squeezed through.

See our note above.—Ed.

Boston

C. A. O'Dea, Correspondent



C. A. O'Dea

The Boston House is fortunate in being able to refer to its baseball team as State Champions. This title we obtained last year by playing and beating the best teams in the State. From the box scores published for some time past in the NEWS we fail to find wherein there is a team from any of the Western Electric Houses that would be able to score on us. This applies to Hawthorne, with its wonderful team, and New York also. "Bob" Hopkins, our foreman, has become a royal roofer, and is now one of the committee that manages the team.

In keeping with the times, the Edison Electric Illuminating Company of Boston instituted a guessing con-

test with its window display. On a large poster, Uncle Sam was painted in full size and was outlined with stitching. The poster was placed close to the window, so that the stitching was easily seen, and prizes were offered to the one guessing nearest to the total number of stitches outlining the figure of Uncle Sam. The first prize was a No. 1 Western Electric Sewing Machine.



Why Work When Parades Go By Our Windows Every Hour? Mr. Gilmore, it is Rumored, Has Requested Bids on Stained-Glass Windows

BOSTON GIRLS EN FETE

During the past winter and spring Boston was represented with several bowling teams, among which were two girl teams. Right here let us state that the damsels at the Hub are SOME bowlers; and if on occasion, any one of our number rolled a string of less than 75, that girl was in disgrace, inasmuch as the average performance was very close to the century mark. (No, we did not use "DUCK" pins.—This latter in response to a possible query.)

Now, it is in order that we pay a tribute to Charlie O'Dea! Some of you will say, O'Dea? O'Dea?—we know him not. For Boston is synonymous with Messrs. Gilmore, Abely, Case and Shay. However, Charlie O'Dea, familiarly known as "Hank," is the man behind the gun, as far as athletics and sports are concerned at "385." Hank, in businesslike fashion, arranged for the bowling on a rebatable plan, whereby, at the end of the season, there was to be a "come-back" for *something good*.

The end of the season approaches and the girls are in suspense. Can it be that the Boston girls are actually to have a blow-out? Time and again have we scanned in the NEWS photographs of Western Electric men participating in banquet festivities; many and oft have been the occasions when we have been envious of Hawthorne's soirees. Frequently have we bemoaned the fact that Chicago's girls could boast of a "pianner."

P. S.—ANOTHER TRIBUTE TO CHARLIE O'DEA! The Girls' Bowling Teams have been *given* twenty dollars, to do with as they wilt. Two dollars per capita for an evening's entertainment. We decided that the program should consist of "eats and the theater." Some of us thought it should be "theater and eats"; but we will not elaborate on this point.

We had a dandy party, but if you ask for photographic evidence—we *are not enclosing a photograph*. Experience teaches.
E. M. T.

If the next issue of the NEWS does not contain some stirring verse by W. M. G., of Chicago, in repudiation of that veiled insinuation by Philadelphia that the recent photograph of Chicago's girls did not portray (for a particular reason) any feet, we shall be very much disap-

pointed. We know of many times when the gentler sex have rushed to W. M. G.'s defense when he was unquestionably getting the worst of a pitched battle.

Chicago

R. F. Young, Correspondent

E. A. Bell, who is a bell hanger in Elgin, called us up recently on a long-distance Bell line regarding a bell which was short in a shipment. A. F. Bell, of our Claim Division, heard the telephone bell ring and answered it. We might even add that the switchboard operator who handled the call in our building is some "belle," too.

One of our customers shipped in a telephone for repairs. We sent him an acknowledgment reading "1 317 set to be repaired C. O. D." and customer, on receipt of acknowledgment apparently decided that the 317 represented a fair cost of repairs, for he proceeded to mail \$3.17 in to us. F. F.

To a real, sure-enough reporter, every item of news in the paper is a "story." When a "story" is published exclusively by one paper, it is declared a "beat" or a "scoop." It is the ambition of all genuine reporters to "scoop" their contemporaries in the business.

So this "story" is a "scoop" on the news correspondent of the General Merchandise Department at Hawthorne. It is a tragedy of the cool weather.

A number of the men in the offices of the G. M. D. agreed some time ago to wear white shoes this summer "down to business," as they say on Broadway. They also decided that all should appear first on the same day shod in white. So the boys bought their white shoes at \$4.50 or thereabouts per pair early in May. Ever since they have been waiting—and rather impatiently of late—for a warm day to come along in order to startle the shop natives by the simultaneous appearance of the members of the white shoe brigade.

A Letter of Thanks

THE following letter from Dr. Lumpkin, President of the Coles County Telephone & Telegraph Co. to District Manager Cullinan at St. Louis, refers to the relief work made necessary by the terrible wind-storm which devastated the section around Mattoon, Ill., recently:

Mattoon, Ill., June 9, 1917.

Dear Mr. Cullinan:

I want to thank you personally for your Company's very generous contribution to the Mattoon Relief Fund. Your check has been handed to Mr. Kinzel, treasurer of finance committee, who will make official acknowledgment. I also want to assure you of our appreciation of the most excellent service rendered by your Company in taking care of our emergency orders for material. We telephoned our order on Sunday afternoon for two carloads of cable, several cars of poles, and a large amount of miscellaneous material, all of which was loaded and shipped the next day. We are also indebted to Mr. Cherry who came to Mattoon the day following the storm and remained with us for four days, during which time he gave us much valuable assistance. Again thanking you, and with kind personal regards, I am,

Yours truly,

W. C. LUMPKIN,
President.

Read This and Envy

Did you ever buy bonds when you were this old? We'll bet you didn't—even if you were a boy wonder with a large ambition, as, of course, you were.

This young chap's name is Frank Monachello. He runs one of the duplicator machines in the Chicago office. He was among the first to fill out an application for a Liberty Bond.



Called "Using the Bean," Is It Not?

F. C. Kramer, service clerk at our Indianapolis warehouse, has been allowed to use the pseudonym of Herlock Sholmes. Our Indianapolis warehouse received a postal card a few days ago asking to trace a shipment. The card bore no signature or post office mark, but did show the cancellation mark of the South Bend and Terre Haute Railway post office. That was the only tangible clue to the card's origin, and it indicated that writer had been traveling on above line. Our Hoosier sleuth started work on the case by comparing the writing on the card with that of various orders from customers along that railroad. By this means he succeeded in locating the writer, with the result that customer's two barrels of "Blue Bells" were traced and delivered speedily.

J. Sorenson Secured the Largest Number of New Customers in March

THROUGH an unfortunate error in the June issue of the News, credit for securing the greatest number of new customers during the month of March was given to F. O. Lightfoot, Chicago, instead of Jo Sorenson, Seattle. Mr. Lightfoot stood first for the month of February, but in March Mr. Sorenson led.

Latest available figures in the salesmanship contests follow:

Results of New Customers and New Business Contest for April, 1917

The salesmen securing the largest number of new customers during April were (tied for first place):

- D. F. Roseborough, Omaha.
- E. C. Whitehead, Atlanta.

The salesmen securing the highest number of points or sales to new customers for the period ending April 30th were:

- G. McCallum, Kansas City, 332 points.
- A. B. Spicer, St. Louis, 270 points.
- A. B. Vandercook, Los Angeles, 218 points.

Western Electric News

PUBLISHED
MONTHLY

FOR THE
EMPLOYEES

BY THE WESTERN ELECTRIC COMPANY, INCORPORATED

H. B. Thayer, *President* H. A. Halligan, *Vice-President*
W. P. Sidley, *Vice-President* A. L. Salt, *Vice-President*
and *General Counsel* and *Gen. Purchasing Agt.*
Gerard Swope, *Vice-President* H. F. Albright, *Vice-President*
and *General Sales Manager* and *Gen'l Superintendent*
J. W. Johnston, *Treasurer* F. B. Jewett, *Chief Engineer*
G. C. Pratt, *Secretary* R. H. Gregory, *Comptroller*
C. E. Scribner, *Consulting Engineer*

Office of publication and address of President, Secretary, and Treasurer, 195 Broadway, New York City.

BOARD OF EDITORS

P. L. Thomson, *Editor-in-Chief*

P. K. Condict B. C. Estep S. W. Murkland
W. F. Hendry P. J. Holdsworth H. D. Agnew
John Colter Reed Calvin

Subscription: \$1.50 per year, except to employees of the Western Electric Company, to whom copies are furnished free of charge.

All communications and contributions should be addressed to WESTERN ELECTRIC NEWS, 195 BROADWAY, NEW YORK.

Matter intended for any given issue must reach New York not later than the 12th of the preceding month.

VOLUME VI JULY, 1917 NUMBER 5

THE WESTERN ELECTRIC AND THE WAR

THE day of the selective draft is at hand. Possibly by the time you get your copy of the News the lists of those drawn for military service already will be filling the columns of the newspapers. Of the 9,500,000 registered men in the land about 650,000 will be required for the ranks of the army—that is, approximately 7%. Every State and subdivision of it is preparing to furnish its quota of men on this basis.

It is worthy of note that the ranks of the Western Electric Company have already, at this writing of June 23rd—before any draft has been made—furnished the Government with many more men than would be required of it were the draft apportioned among industrial concerns instead of States. For 9466 is the total number of Western Electric men who registered on June 5th, and already 849 Western Electric men are in the country's military service—either in the National Guard, Signal Corps, or other branches of the army and navy, or in the National Guard units, which will be called to the colors within the next few weeks. Thus instead of furnishing the required 7% of the number of registered men, the Western Electric Company has already yielded about 9% from its ranks.

Nor should it be forgotten that many of the 850 men are trained specialists in their line. Two radio or wireless telegraph companies have been recruited exclusively from Western Electric ranks for the Signal Reserve Corps; and many telephone experts from our

ranks are acting as officers and privates in other companies of the corps, where their technical knowledge and experience will be of great use to the army and navy.

The figures above are interesting, and they are ones to be proud of, but they are not by any means a true measure of the extent of the Western Electric Company's "bit." It may not be so dangerous a job to run a machine in the shops as to raid the enemy's trenches—but it is absolutely just as necessary to the successful prosecution of the war. Indeed, in some ways it is more necessary, for, according to recent estimates, every soldier in the field has to be backed up by three members of an industrial army at home—to furnish him with clothing, ammunition and other supplies. Each sailor, it is said, must have seven industrial workers behind him to keep him supplied with the necessities demanded by modern naval warfare. Our part, of course, in this great conflict is to maintain the great systems of national communication—the telephone and telegraph, and to keep the army and navy of our own country, as well as those of our allies, constantly supplied with communication equipment. It is a vital work, and the thousands of men and women in the Company who will never see the firing line will be doing their "bit" by putting extra energy into their jobs and working hard for the Government in the Western Electric Company.

THE LIBERTY LOAN

AS the NEWS goes to press figures come from the comptroller that over \$400,000 in Liberty Loan Bonds was subscribed by employees of the Western Electric Company. This sum—\$413,900 to be exact—represents only a part of the subscriptions by employees, for many, it is known, had subscribed through their local banks.

There were 5,596 Western Electric subscribers through the Company—practically all of them on the pay deduction basis.

OUR WAR ISSUE

THE August issue of the NEWS will be a special *War Issue*. It will contain not only full lists of Western Electric men in the various branches of Government service, but news from some of our Allied companies abroad—many of whose employees have been at the front for a long time.

To none will this issue be more interesting than to the hundreds of Western Electric boys away from home on military duty. The NEWS goes to them every month wherever they are, and the August *War Issue* will be of all the more interest to them if you will send in that little snap-shot you have of some other Western man, in military uniform, or that little story you heard the other day about him.

Our Vacation Photograph Contest

LAST year in its October issue the NEWS exhibited a large number of pictures of Western Electric people snapped in the act of enjoying their vacations. Never was any issue more talked about than this.

If you want to have another look at how Western Electric men and women spend their spare time for their vacations, and perhaps win a prize, then keep the NEWS in mind when you go kodaking this summer and send in some photographs.

There will be a first, second and third prize. The pictures will be judged not alone on their photographic technique, but on their "interestingness" and "newsiness." Distinct preference, in fact, will be given to those photographs which contain either a Western Electric employee or a scene involving something of Western Electric interest. Do not send "still life" pictures—have the man or women in the picture *doing something*.

Terms: The contest is open to all Western Electric employees and employees of our allied houses.

Put your name and department on the back of all pictures submitted.

Address entries to the "Vacation Contest, THE NEWS, 195 Broadway, New York."

Send your pictures so that they reach New York by noon of September 14th.

First Prize:

Choice of

One Western Electric Warming Pad;
One Western Electric 6" Fan, or other
Western Electric Merchandise to the value of \$8.00.

Second Prize:

Choice of

One Western Electric No. 1 Iron;
One Western Electric No. 15 Silk Shade Portable Lamp, or other
Western Electric Merchandise to the value of \$5.00.

Third Prize:

Choice of

One Western Electric Brass Portable Lamp;
One No. 1 Western Electric Lantern, or other
Western Electric Merchandise to the value of \$3.00.

A Letter from Abroad

**OPENED BY
CENSOR.**

1839

How it Came

Waldorf Hotel,
Aldwych, W. C.,
May 24, 1917.

Dear Mr. Gilman:

By this time you know we have arrived safely, but you may be glad to hear we are all well, and were very good sailors. Lieut. Grace has been assigned for a few days with the enlisted men at Blackpool, but Miss Evans and myself are very comfortably located in this hotel.

I have just been talking to Mr. Pingree on the 'phone, and he has kindly consented to telegraph Mr. Halligan of our safe arrival. Later we hope to present our letters to him.

Again we wish to thank you for your many kindnesses to us, and we want you to know it has been a great help to us to have so many kind friends.

Somehow things have moved so fast that we feel as if it was all a dream so far. We can never forget the very thrilling farewell salute of dipping the flag, which you gave us from the roof of 463 West Street, as we passed down the river. Every one on board appreciated it too. Kindest regards to all our interested friends.

Very sincerely,

JANE I. RIGNEL.

Married

April 9th.—Miss Anna Kubes, of department 7381, Hawthorne, to Paul Rizman, Chicago.

May 1st.—Miss Sophie Neudecker, of department 7069-C, Hawthorne, to Rene Mathis, Chicago.

May 5th.—Miss Veronika Dempkowska, of department 7381, Hawthorne, to Martin Szanke, Cicero, Ill.

May 5th.—Miss Mary Bukowska, of department 7381, Hawthorne, to Stephen Zojfet, Chicago.

May 9th.—M. H. Putnam, department 6963, Hawthorne, to Miss Annette Hibbard, of Montour Falls, N. Y.

May 12th.—Miss Lillian Jansky, of department 7393, Hawthorne, to James Hons, Chicago.

May 15th.—Miss Edith Bacher, of department 7682, Hawthorne, to Rudolph Blecha, Chicago.

May 19th.—Miss Mary Murphy, of department 7381, Hawthorne, to Patrick Shea, Chicago.

May 19th.—Miss Josephine Janorski, of department 7381, Hawthorne to John Oaklan, Chicago.

May 26th.—Mary Kamps, of department 7381, Hawthorne, to Edward Goers, Chicago.

June 2nd.—Miss Bessie Sramek, of department 7393, Hawthorne, to Rudolph Blecha, Chicago.

June 5th.—Miss Mary Gravy, of department 7381, Hawthorne, to Stanley Wabansia, Chicago.

June 6th.—Miss Mary Jaunvish, of department 7381, Hawthorne to Charles Feeberg, Chicago.

June 9th.—Miss Frances Dietz, of department 7381, Hawthorne, to Albert Schriber, Chicago.

June 10th.—Miss Jeanette Kotes, of department 7682, Hawthorne, to Charles Schuetz, Chicago.

June 12th.—Miss Julia Goette, Philadelphia Office Service Department, to Mark Dalton.

June 16th.—Miss Minnie Zessin, of department 7381, Hawthorne, to William Marquardt, Chicago.

FOREIGN NOTES

SOME ITEMS OF INTEREST FROM ABROAD



New York

From A. E. Reinke, at Petrograd, comes this picture of Mr. Otto, vice-president of our Allied Petrograd House.

"This type of conveyance known as a sanky," writes Mr. Reinke, "is still very popular. The driver weighs about 300 pounds, I should judge, and keeps one foot outside on the iron support so that when the sanky hits a rough spot on the road and tips, the driver steps out gracefully and unruffled. Mr. Otto and I in the sanky are not provided with such an iron support. The driver is not sitting in our laps, but sits close enough to keep us warm. This horse is one of the few in Petrograd not requisitioned for the war."



J. J. McKenna



J. W. Foard

On June 3rd J. W. Foard returned to New York, after an absence of four and a half years in Japan and China. During the first three and a half years of his stay in the East, Mr. Foard was Stores Manager of the Nippon Electric Company, our allied house in Tokyo, and for the greater part of his last year he was Acting Manager of our new house at Shanghai, during Mr. Fairman's leave of absence in this country. With one exception, Mr. Foard has made the longest stay of any of the Americans who have been stationed in the Far East. He has been warmly welcomed on his return by many old friends in the company.

Early in June we had the pleasure of a visit from Mr. C. B. Cannon, a representative of the Sao Paulo Telephone Company, of Sao Paulo, Brazil.

Gisli J. Olafson, Manager of Telegraphs and Telephones, Reykjavik, Iceland, spent some time with us at New York during June, and he is expecting to visit Hawthorne later. Many Western Electric people remember meeting Mr. Olafson two and one-half years ago on his previous visit to this country, when he came over on the steamer *Gulfloss*, the first steamer to make the direct passage from Iceland to the United States since the days of the Norsemen.

J. J. McKenna, who has been in Europe for the past three and a half years, arrived in New York during the month of May, for a short visit, and expects to return to London early in July.

Montreal

The Telephone Shop Team won the President's cup for the 1916-1917 Season. Thirty-three other prizes, valued at \$110.00, were given by the Northern Electric Athletic Association, officers of the Company, heads of departments and the bowlers themselves. Prizes given were merchandise orders placed on various concerns.

TEAM STANDING:		Won	Lost
Telephone Shops	57	9
Engineers	42	14
Merchandise	48	18
Sales	46	20
Montreal House	43	23
Accounting	33	30
Factory	24	42
Mechanics	24	42
Cost	22	44
Maintenance	22	44
Production	20	46
Rubber	3	63

The Winning Team

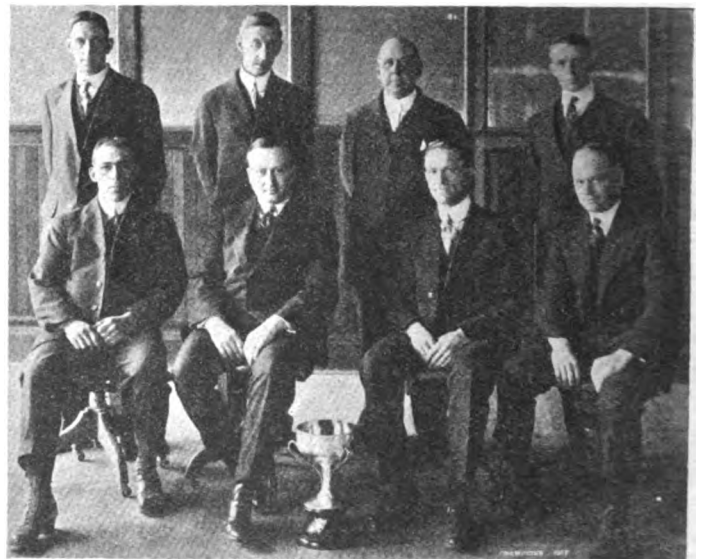

Back Row, From the Left: A. Post, E. Cammell, A. M. Carter, H. McCann. Sitting, From the Left: J. Rose, A. Brunet (Captain), G. Mütner, J. Dicaire

Activities of the Hawthorne Club

The Card Party and Dance

IN these days, when all the dance music comes from Hawaii, it makes very little difference which form of entertainment you choose at card party and dance. If it's euchre you sit down and shuffle; if it's ukalele you stand up and shuffle. In either event, if it is an entertainment such as that given by the Hawthorne Club at the West Side Masonic Temple May 18th, you have a good time, unless you have made up your mind to be different from all the other thousand guests who enjoyed themselves so thoroughly that evening.

Prizes were given to the twelve best euchre players. First went to Mrs. P. Miles; second to C. Anderson; third, J. C. Wanito; fourth, C. Bollinger; fifth, W. J. McCann; sixth, Edward Radtke; seventh, Mrs. Hornung; eighth, Joseph Holman; ninth, Rose Stluka; tenth, P. A. Morris; eleventh, A. W. Goyer, and twelfth, Miss Flora McGowan.

The Girls' Camp at Round Lake

You remember—or probably you don't remember—the inspired press agent's description of Round Lake, which we ran a couple of months ago before anyone had any better information about the Hawthorne girls' summer home. We ran it in "quotes," and intimated that we considered it should be subject to about 50 per cent. discount for bunk. We apologize. But how could anyone be expected to know that any such monstrosity existed as a conservative press agent? Why, President Dean and the committee members who opened the camp officially by week-ending there June 2nd and 3rd, can talk circles around that press agent when it comes to enthusing about Round Lake! Don't ask any of them about it when you want to catch a train, for you'll never get away in time.

And if you are a Hawthorne girl, privileged to spend your vacation at the Round Lake camp, you certainly will not want to miss that train. Chicago, Milwaukee & St. Paul road, and the round trip costs \$1.25. The details were printed before, but people never do seem to remember these things. Club girls pay \$1.50 for week-end accommodations, and \$8.00 for a week's room and board. Other Hawthorne girls pay \$2.00 and \$9.00.

Hawthorne Works Moving Pictures

At the present price of shoe leather, the best way to enjoy a trip around the Hawthorne Works is from the seat of a movie theater, and about 1,500 people took advantage of the opportunity to do so at the West Side Masonic Temple on June 9th. Three reels of film were shown, picturing Hawthorne and Hawthorne people. Besides a tour through the grounds, the film contains views of play-ground ball games, tennis games, a Gun Club shoot, a Western Electric Band concert, our fire department in action, a fire drill in the coil winding department, views in the hospital and restaurant, the educational department laboratory, the Company's apprentice shop, the big electro-magnet loading cars with scrap iron, and nu-



A "STILL" FROM THE HAWTHORNE MOVIES
 "Shorty, the Chauffeur" (Thomas Wolcott) Gives "The Hick"
 (K. E. Sutherland) a Jitney Ride Around the Works

merous other Hawthorne scenes. Enough plot is woven into the scenario to give continuity to the scenes shown. The story opens with K. E. Sutherland, of the inspection investigation department, vice-president of the Hawthorne Club, working overtime at his desk. Among the papers he is looking over he finds an application sheet sent over from the employment department, containing an inexperienced farmer boy's application for a position. This sets Karl to wondering what kind of a job he would hold if he had been uneducated and inexperienced when he started with the Company over ten years before. The thought impresses him so forcibly that when he falls asleep over his work a short time later he dreams he actually is a farmer boy applying for work.

The next scene shows him entering the main gate, dressed up in a complete "Hick" costume. As he steps inside he is spied by T. Wolcott, of the mill-wright department, who decides to scare him with the little electric truck used by the mill-wrights to transport their tools and material about the works. Jumping upon the "jitney" Wolcott forthwith proceeds to run into the "Hick" from behind. The victim falls aboard the truck, and the tour of the Works begins.

At the end of the tour the "Hick" succeeds in jumping from the truck and getting into the employment office, where he lands a job. The rest of the film shows his experiences at work and while looking around the plant at noon. These scenes give Mr. Sutherland a chance to show his ability as a comedian, and he certainly makes the most of the opportunity. As one of the spectators remarked after seeing the film:

“Everybody knew Sully had a keen sense of humor, but most of us didn’t suspect he was such a darned good comedian.”

The other members of the cast also played their parts like professional movie actors. Besides Mr. Sutherland, the following people took part in the plot of the film: John Harper, Thomas Wolcott, Martin Donnelly, F. J. Holdsworth, F. Armitage, H. D. Childs and Misses Mina Mohr, Mary Kiley, Eileen Penfield, Mabel Roddy, Mayme Fenn, Mabel De Lot, Jane Benson, Florence McCann and Bernice La Gess.

The Hawthorne Gardens

Speaking of amusements and musical comedies, what would you guess the Hawthorne Gardens are? Well, they are not a new kind of a play. In fact, they are not play



THE LIBERTY “LOAM”

Hawthorne Club Gardeners in the Trenches Preparing an Attack Against the High Cost of Kaisers

at all, but work, and a new kind of work, at that, for some of us.



The New Hawthorne Plant. We Use the By-Product for Fishing

To aid in the work of increasing the nation’s resources the Hawthorne Club has had a tract of 175,000 square feet plowed and prepared for planting. The ground, which is the property of the Company, is located south of Twenty-second street, between Forty-ninth and Fiftieth avenues.

The garden space was divided into 175 plots, and offered free to Club members. At once it became evident that those 175 plots would have to work for their lodgings this summer. In fact, most of them already are showing results of the early spring drive against food scarcity.

To aid inexperienced gardeners in their work, a series of lectures were given in the lecture room of the educational department, resulting in the organization of the Hawthorne Garden Club, which holds regular meetings for lectures and discussions on gardening matters.

Later in the season these garden “fans” will probably want to get together in a big produce show, and the NEWS may be compelled to get out a special agricultural number to cover the affair. At any rate, there is going to be a lot of nice fresh vegetables raised, and every beet helps beat the Kaiser.

Farmland über alles!



HAWTHORNE E. A. ATHLETICS

MEMBER



There are to be three means of outlet for the girls’ tennis enthusiasm: A classification tournament, started June 1st, and later in the season there will be championship singles and doubles matches.

About seventy entries have been turned in for the girls’ classification tournament, which will be conducted along the same lines as in previous years, with prizes for the winners in various groups of classes.

The class tournament for men is now in full swing,

with 94 entries. The standing in the Commercial League after three matches is as follows:

	Won	Lost	Per cent.
Sears-Roebuck	22	3	880
Western Electric	17	9	654
Chicago Telephone	8	10	444
Peoples Gas	4	14	222
Commonwealth Edison	1	17	056

On May 29th the tennis team journeyed to Milwaukee to play a match on Decoration Day with the Washington Park Tennis Club, champions of that city. They were unfortunate in having the weather man with the home team, as his liberal distribution of rain prevented the match. Play was attempted during the rain, but was

given up after a few rackets, a couple of dozen balls and two courts were spoiled.

However, the weather did not interfere with the entertainment features of the trip. Mr. Day, of the Western's Milwaukee sales force, was on the job with his 7-passenger car, rendering the usual Western Electric service, transporting the boys around town. Another trip is to be made when the weather is more favorable.

The Western Electric Tennis Association has recently become a member of the Chicago Tennis Association, which is the Chicago branch of the Western Lawn Tennis Association, the governing body for tennis in seven Middle West States. The Chicago Association has a membership of thirty-six clubs, which comprises all the tennis clubs of importance in Chicago.

Our team in the Chicago Association matches will have an opportunity to meet most of the best players in the city. The membership is also valuable in that any Hawthorne tennis player is eligible to compete in any sanctioned tournament. Such good competition should do much to develop our players.

Commercial League Baseball

Our baseball rivals from the Illinois Tool Works put in their appearance at our park Saturday, May 12, 1917. For five innings there was a real pitchers' battle between Williams and Nelson. In the sixth, Williams weakened, two doubles and a single resulting in two scores, putting the game on ice for the Tool Works. Neither side scored after this. Our lone run was scored by Kavanaugh, who drew a walk, went to third on an infield out, and scored on a wild throw intended to head him off at third. Below are the box scores.

ILLINOIS TOOL CO.							
Player	R	H	SH	SB	PO	A	E
Foreman, 3b	0	0	0	0	1	3	0
Hanks, rf.	0	1	0	0	0	0	0
Bullen, cf.	0	0	0	0	0	0	0
Kilbey, 1b.	1	1	0	0	13	1	1
Uhlman, lf.	2	1	0	0	2	0	0
Spreitzer, 2b.	0	1	1	0	2	3	0
Mienke, ss.	0	0	0	0	2	2	0
Armstrong, c.	1	1	0	0	6	0	0
Nelson, p.	0	0	0	0	1	6	0
Totals	4	5	1	0	27	15	1

WESTERN ELECTRIC CO.							
	R	H	SH	SB	PO	A	E
Swanson, cf.	0	1	0	0	3	0	0
Fox, rf.	0	0	0	0	1	0	0
Jameson, 2b.	0	1	0	0	1	3	0
Kavanaugh, lf.	1	0	0	0	1	0	0
Fiene, 1b.	0	0	0	0	15	1	0
Evans, ss.	0	0	0	0	1	4	0
Chouinard, 3b	0	1	0	1	1	4	0
Rehor, c.	0	2	0	0	4	0	0
Williams, p.	0	0	0	0	0	4	1
Totals	1	5	0	1	27	16	1

Illinois Tool Co. 0 0 1 1 0 2 0 0 0—4 5 1
 Western Electric Co. 0 1 0 0 0 0 0 0 0—1 5 1
 Two-base hits—Jameson, Kilbey, Uhlman. Struck out—By Williams, 4; by Nelson, 6. Bases on balls—Off Williams, 3; off Nelson, 2. Hit by pitched ball—Swanson, Uhlman. Double play—Mienke to Kilbey. Umpire—Driscoll.

The features of the game with the Stewart-Warner Speedometer Company team were the pitching of "Cy" Young and the base running of F. Jameson, who scored what proved to be the winning run by stealing home. In two out of four innings pitched "C" Young retired the

entire side by the strike-out route. Out of a total of twelve batters facing him, he struck out ten. The game was played May 19th at Hamlin Park. Below is the score:

WESTERN ELECTRIC CO.					STEWART-WARNER SPEEDOMETER CO.				
	R	H	PO	A		R	H	PO	A
Madigan, lf.	0	0	0	0	Bein, rf.	0	0	2	0
Chouinard, lf.	0	0	0	0	Lebbin, ss.	0	2	3	1
Fox, rf.	1	2	0	0	Groth, 1b.	0	1	6	0
Jameson, 2b.	1	3	0	3	Kasman, 2b.	0	0	0	0
Englehardt, 1b.	0	0	6	0	Rothermel, cf.	0	0	0	0
Fiene, 1b.	0	1	1	0	Lebbin, W., 3b.	1	2	0	1
Swanson, cf.	0	0	1	0	Stalzenbach, lf.	0	0	2	0
Evans, 3b.	0	0	1	1	O'Malley, c.	0	0	7	2
Ginners, ss.	0	0	0	2	Kimmith, p.	1	0	1	1
Rehor, c.	1	2	12	0					
McGuire, p.	0	0	0	0					
Young, p.	0	0	0	0					
Totals	3	8	21	6	Totals	2	5	21	5

	1	2	3	4	5	6	7	R	H	E
Western Electric Co.	0	0	2	0	0	1	0	3	8	0
Stewart-Warner Speedometer Co.	1	1	1	0	0	0	0	2	5	2

Errors—A. Lebbin, Rothermel. Hit by pitched ball—Kasman, Stolzenbach. Stolen bases—Jameson, 2; Fox, Rehor. Two-base hit—Jameson. Three-base hit—W. Lebbin. Home run—W. Lebbin. Struck out—By McGuire, 2 in 3 innings; Young, 10 in 4 innings; Kimmith, 9 in 7 innings. Base on balls—Off McGuire, 1; Young, 2; Kimmith, 5. Umpire—Driscoll.

On Saturday, May 26th, and Sunday, May 27th, our boys played two games with the strong Norwoods, of Cincinnati, at Norwood Park. The Norwoods at present are world's amateur champions. Saturday's game was a pitchers' battle between Earl Yingling, formerly with Brooklyn and Cincinnati, and our Dick Cantwell. Three errors, a base on balls, and 3 hits scored 4 runs in the first for Norwoods. After this Cantwell had them eating out of his hand. Fiene's two doubles sent in both of our runs. With perfect support the score would have been 2-1, in our favor.

On Sunday, "Cy" Young, our celebrated underhand pitcher, hooked up with "Red" White, formerly with Pittsburgh. Two innings were played before Jupiter Pluvius was king for the day. On Jameson's triple, Tenant's single, his steal of second, and Evans' single, two runs were scored. The Norwoods were unable to solve "Cy's" delivery for any runs, and besides he struck out the first three batters. Game called 2-0. Below is the box score of Saturday's game:

NORWOODS					WESTERN ELECTRIC				
	H	PO	A	E		H	PO	A	E
Weil, ss.	1	3	5	0	Ginners, ss.	0	0	2	1
Holly, cf.	1	3	0	0	Madigan, lf.	0	0	1	1
Dell, lf.	1	1	0	0	Jameson, 2b.	1	0	1	1
Magness, 2b.	3	0	3	0	Fiene, 1b.	2	8	0	0
Tiemeyer, 1b.	0	17	0	0	Rehor, c.	1	4	2	0
Mulvaney, rf.	2	1	0	0	Williams, cf.	0	2	0	0
Short, 3b.	1	0	3	0	Evans, 3b.	2	1	1	0
Munson, c.	0	2	0	0	Reed, rf.	0	2	0	0
Yingling, p.	1	0	5	1	Cantwell, p.	1	1	2	0
Totals	10	27	16	1	Totals	7	24	9	3

	1	2	3	4	5	6	7	8	9	R
Norwoods	4	0	0	0	0	0	0	0	0	*—4
Western Electric	0	0	0	0	0	1	0	1	0	—2

Two-base hits—Rehor, Fiene, 2. Three-base hits—Mulvaney, Magness. Double plays—Yingling to Weil to Tiemeyer; Ginners to Fiene. Base on balls—By Yingling, 2; by Cantwell, 1. Struck out—By Yingling, 2; by Cantwell, 3. Umpire—Peitz.

On June 9th the T. E. Wilson Company ball players put in their second appearance at our grounds. The game was close until the seventh inning, when Fiene's three-base drive with the bases loaded settled matters entirely in our favor. The game brought out a very promising pitcher, E. Maager, from whom much is expected. We won 5-2.

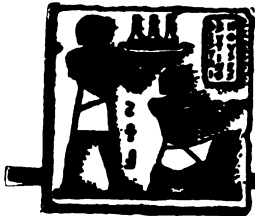

NEWS FROM HEADQUARTERS

Some Items of Interest from the General Departments

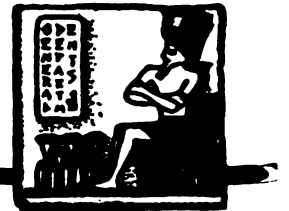

General Sales Department

W. A. Wolf, Correspondent

THE WAR COMES HOME

War!
 Yea—War.
 What else has been the mental portion
 Daily served to us for near three twelve-months
 By the nation's press?
 War—flaunted before our eyes
 In screaming bold-face type—
 With its sordid tales of countless men
 Lost forever to the world.
 And yet
 Has the war seemed distant.
 Then
 Have come the solders khaki-clad,
 With faces stern and set,
 As if with purpose high imbued.
 The uniform a symbol of their consecration
 To the country's dire need.
 Daily have we seen them on our thoroughfares,
 Singly or in groups,
 And yet
 Has the war seemed distant.
 Then
 Came the day
 Upon which the youth of our land
 Placed their names upon the indelible register
 That shall serve
 Upon a not far-distant date,
 To choose a nation's army that goes forth

Full panoplied to battle
 To bring peace into a strife-torn world.
 And yet
 Has the war seemed distant.
 Then
 Came the call
 To all who people this our country.
 A call
 To place upon the altar of their liberties,
 But for a time,
 A portion of their moneys;
 That those who go to foreign lands
 For our common cause
 May have all they do need to give them power.
 And yet
 Has the war seemed distant.
 Then
 Came the day
 As of a surety the fates ordained
 The day must come
 Upon which this dread war must venture
 Unto our very door;
 When some one thing must come to pass
 That never did before.
 Yea—
 The war is here.
 For we—conservative unto the bitter end—
 Now have
 Within the sacred portals of the Advertising Department
 A woman copy-writer.
 The war is here—
 At home!

—W. A. W.



CURRENT AWARDS OF OUR SERVICE BADGES

THIRTY YEARS

Kearsley, R. C., Chicago	July 21
Hauser, E. A., Hawthorne, 5376	July 7
Ciani, A. A., New York	July 16

TWENTY-FIVE YEARS

Gahan, Lulu, Hawthorne, 6326	July —
Johnson, L., Hawthorne, 6301	July —
Cohen, A., Hawthorne, 7383	July 5
Krueger, Minnie, Hawthorne, 7394	July 7
Acker, C. P., New York	July 1
Just, W. C., New York	July 1

TWENTY YEARS

Stoltman, Jennie, Hawthorne, 6377	July 1
Koukol, L., Hawthorne, 6305	July 24
Sloan, J., New York	July 28

FIFTEEN YEARS

Gilmore, H. B., Boston	July 14
Woy, W. J., Hawthorne, 5933	July 2
Martin, L., Hawthorne, 6300	July 3
Dignam, R., Hawthorne, 6302	July 7
Robertson, W. L., Hawthorne, 6615	July 7
Bronson, D. F., Hawthorne, 5060	July 9
Lawler, J., Hawthorne, 6035	July 9
Christ, H., Hawthorne, 9359	July 14
Larson, L., Hawthorne, 5915	July 14
Phillips, V., Hawthorne, 5756	July 17
Becours, G., Hawthorne, 5756	July 19
Radtke, C. A., Hawthorne, 6460	July 19
Repenning, H. R., Hawthorne, 5929	July 23

Leaver, A. E., Hawthorne, 6460	July 26
McCracken, Lena, Hawthorne, 6327	July 29
Miller, H., Hawthorne, 5351	July 29
Farwell, E. C., Hawthorne, 5922	July 30
Murray, L. A., Hawthorne, 5136	July 31
Stone, T. R. H., Hawthorne, 6505	July 31
Minor, C. H., New York	July 1
Heyer, G. K., New York	July 1
Farnell, W. C. F., New York	July 2
Neave, P. M., New York	July 16
Phillips, G. S. V., New York	July 23
Smith, G. K., New York	July 16

TEN YEARS

Edwards, Edna, Atlanta	July 9
Bakenbring, Anna, Hawthorne, 7392	July 8
Mougey, W. E., Hawthorne, 7986	July 8
Meyer, R. J., Hawthorne, 6166	July 9
Dade, W. H., Hawthorne, 6300	July 10
Shaw, Helen M., Hawthorne, 7037	July 12
Reich, J. C., Hawthorne, 7366	July 15
Schnaubelt, F. J., Hawthorne, 5723	July 15
Vesely, C., Hawthorne, 6035	July 15
Zwillinger, Celia, Hawthorne, 5069	July 16
Idziaszek, J., Hawthorne, 5955	July 19
Rudin, J., Hawthorne, 6410	July 19
Blume, W. T., Hawthorne, 6437	July 29
Ryder, G. R., Kansas City	July 8
Swigert, W., New York	July 9
Walker, W. T., New York	July 8
Harter, Harry L., Philadelphia	July 1
Loucks, Harold E., Philadelphia	July 9

Rollo C. Kearsley



E. C. Kearsley

Mr. Kearsley started in with the Company as messenger boy, and his first job was to deliver the mail from the old factory in South Clinton Street to the post office. Apparently this work was done to the satisfaction of all concerned, for he was soon assigned the responsibility of opening and distributing the incoming mail. He next went into the

Repair Department of the factory, and a little later was put in charge of that department. In his capacity as head of Repair Department, Mr. Kearsley sent the repair orders down to Gerard Swope to write up. Mr. Swope at that time was a junior clerk in the shop. Mr. Kearsley at that time lived out on the West Side in a boarding house with several other Western Electric men, including E. J. Wallis, Dan Richardson and R. H. Gregory in the number. Mr. Kearsley was transferred to the Sales Department about 1907. He is now the municipal salesman for Chicago. In addition, he is an active member of the Order of Good Fellows, and is said to be able to play a cracking game of golf.

E. A. Hauser



E. A. Hauser

E. A. Hauser believes that if ever there is a foreman's versatility contest he will stand well among the leaders. "Ike" believes that he has held more different positions as foreman than any other Hawthorne foreman. He started in the New York Shops in 1887, which, according to the most approved arithmetic, gives him a Western Electric service of 30 years.

Nineteen years ago Mr. Hauser was given his first foremanship as head of the transmitter assembly department, when that job was moved to New York from Boston. A year and a half later he became foreman of the protector department. This department was the first of the New York Shops transferred to Hawthorne in 1907. In addition to running the protector job, "Ike" was successively put in charge of the plug assembly department, the sub-set assembly department and the semi-mechanical department when these jobs were first introduced into the Hawthorne Shops. He is now head of the repair department, where they fix everything made at Hawthorne except loading coils.

If "Ike" sticks to the ship 30 years more it will require a special supplement to list all of his jobs.

A. A. Ciani



A. A. Ciani

Alphonso A. Ciani is another living exemplification of old Bill Shakespeare's lines—"And each man in his time plays many parts." Years ago—he is getting his 30-year service badge this month—Alphonso, with the memory of the spaghetti, risotto and chianti of his native Italy still clinging to his

mind, began his labors as an inspector of plugs, drops and other switchboard apparatus. Then he switched over to the inspection of transmitters and receivers, helping to

keep the manufacturing departments on their toes to turn out apparatus good enough for him to pass.

Later on he became the New York Shop photographer transferring his affections later on to the Engineering Department in the same capacity. There he takes pictures of anything at all—human beings, pieces of inanimate apparatus and charts—with equal skill and equanimity.

A. A. Ciani puts in a good day's work every day of the year, and when he tells you you'll get a photo by a certain date, you do. The News knows.

Arthur Cohen



A. Cohen

Arthur Cohen has spent 25 years with the Company at high pressure work. He operates a lead cable covering press, which works at such an enormous pressure that we fear our reputation for veracity would suffer if we gave you the figures—which, by the way, we have forgotten. Art. has worked on the presses ever since the process was perfected, with the exception of a short period spent in the woodworking department when the cable output fell off during a business depression.

One evening a short time ago he sat down to a little figuring on what he has accomplished in that time. He figured out that during his employment he has put lead jackets on 80,600,000 feet of cable core, and that in 13 years more he will have covered enough to reach completely around the waist of Mother Earth, who, as you doubtless remember, has some figure herself at the waist line. (About 25,000 miles, isn't it?)

Two years after Art. has completed that embracing feat we will write him up for a 40-year service button.

Miss Jennie Stoltman



Miss J. Stoltman

One of the active workers among the women of the Hawthorne Club is Miss Jennie Stoltman. She is one of the Club's accredited representatives and as such has collected many contributions to the Red Cross Fund now being raised at Hawthorne through the Club.

Miss Stoltman's work for the Company has been coil winding and she now has charge of this work in jobbing department 6377. She started at Clinton Street July 1, 1897, which entitles her to wear a two-star button hereafter.

L. Johnson



L. Johnson

Leo Johnson completes 25 years of service with the Western on the 10th of this month. All of his work has been in the wood-finishing departments. Mr. Johnson is an expert at that line of work and is now engaged in finishing repaired woodwork in the cabinet-making and finishing department.

J. Jensen, foreman of the japanning department and formerly in charge of wood finishing, says of Mr. Johnson: "Leo is now 63 years old but doesn't look a day older than he did when he started here, probably because he is still wearing that pompadour that he has always been

noted for. He is never late to work. In fact, he starts from home at six o'clock in the morning and at seven o'clock you can see him standing in front of one of the gates waiting for it to open."

Undoubtedly the last part is slightly exaggerated, but at least Mr. Johnson can fasten on his three-star button with a clear conscience of a clean record.

Miss Minnie Krueger



M. E. Krueger

Residents of Chicago have two dates by which they measure time. One is the fire and the other is the Fair. Therefore Miss Minnie Krueger has no trouble remembering the date when she first began work for the Company in the insulating department at the corner of Van Buren and Clinton Streets. It was the year before the Fair, which, as you probably know, was called the Columbian Exposition, because it was held in 1893, only about a year too late to be the anniversary of Chris' great discovery in 1492.

Miss Krueger well remembers the Western's exhibit, for she had the job of picking out the best looking operator in the factory and teaching her to run an insulating machine so that the dear public might know how in the world we ever got that wire inside of that piece of cloth. She continued in the magnet wire insulating department as section head until ill-health compelled a vacation last year. Since her return she has been employed at clerical work in the cord finishing department.

Miss Lulu Gahan

Winding a coil is no trick at all, provided nobody cares how it is wound, but winding a coil so it will get by West-

ern Electric inspectors is something else again. That is an art. Miss Lulu Gahan learned the rudiments of it back in the old Clinton Street Shops under F. C. Du Plain (father of G. J. Du Plain, foreman of 7381). With the exception of a short experience brazing wire in the black wire department, her entire service with the Company has been in the coil winding department. She is now forewoman in this department and incidentally an instructor of new winders, a job that would seem to require an infinite stock of patience—or profanity. Being a woman, Miss Gahan couldn't relieve her feelings by swearing at the department cat, even if such an animal existed, and besides she thinks patience is a much better bet. "Oh, I never get cross with them," she says. "I know I couldn't do my work right if anyone was cross to me."

Which furnishes a good commentary on Miss Gahan's character and a very passable recommendation for the Western Electric service school, where she gained her 25 years' experience.

L. Koukol

In the 20 years that he has been with the Company, Louis Koukol has drilled holes enough to furnish centers for all the doughnuts made since Eve was a June bride. "Coke" started at the Clinton Street Shops back in 1897. His first job was running a speed lathe in the drill room on drilling and countersinking work. The first 14 years of his service with the Company were in the drilling and tapping department, after which he was transferred to the subset woodworking department, his present position.

Although not a ball-player himself, "Coke" likes to get out and root for the Western team, and he must be a pretty good rooter, judging from our boys' record. Hereafter he can bring another star with him to the sidelines.

Their Badges Show One Star Now



W. C. F. Farnell



C. H. Minor



P. M. Neave



R. Stone



L. A. Murray



H. B. Gilmore



O. A. Radtke



W. J. Woy



G. S. V. Phillips



H. R. Repenning



Lena McCracken



G. K. Smith



W. S. Robertson



J. Lawler



G. Baccours



G. K. Heyer



A. E. Leaver

ECUM

Western Electric News

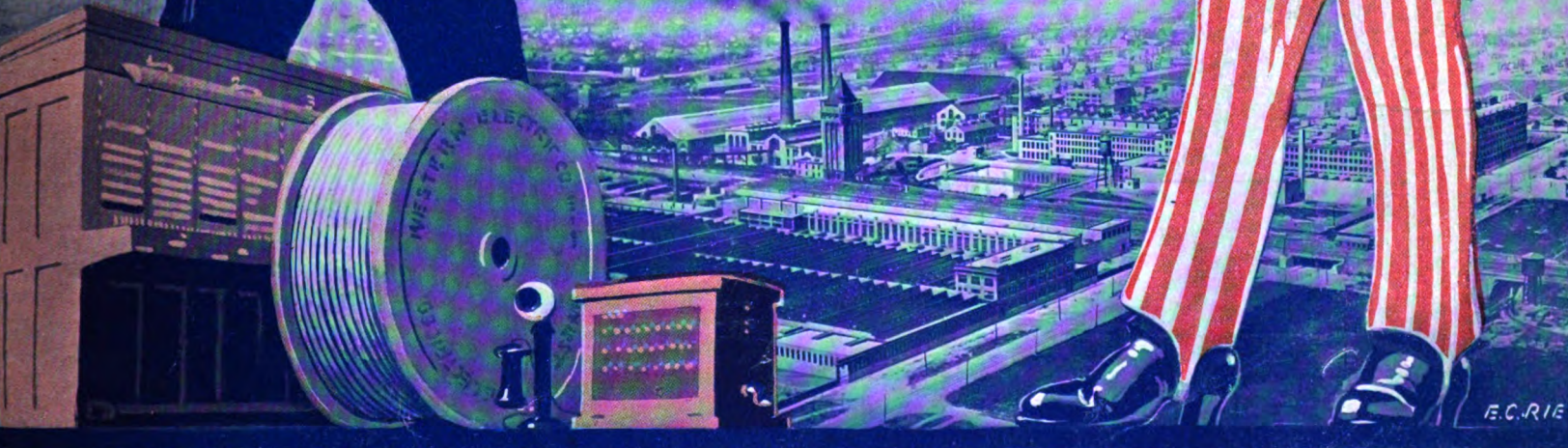

E.C. RIE

VOL. VI ~ NO. 6

AUGUST, 1917

Digitized by Google

FOR PRODUCTION AND PROTECTION

Western Electric

DAVIS

FLOOD LAMPS

For Production

Give your night timber gang the benefit of "electric daylight" from a battery of these lamps—in fact, give all your above-ground workings the same daylight working conditions at night—and watch your production increase.

For Protection

These flood lamps will put a circle of electric daylight around the workings that no marauder or prowler will dare to enter. They make the workings as safe at night as they are in daytime.

One lamp alone placed 60 feet above ground will illuminate an area of over 100,000 square feet.

Write to-day for folder FL-80

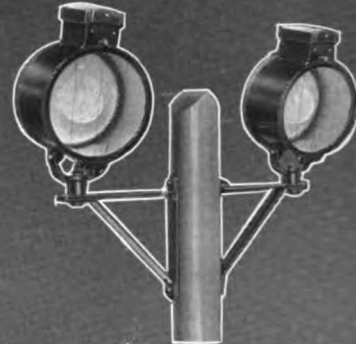

BRACKET TYPE

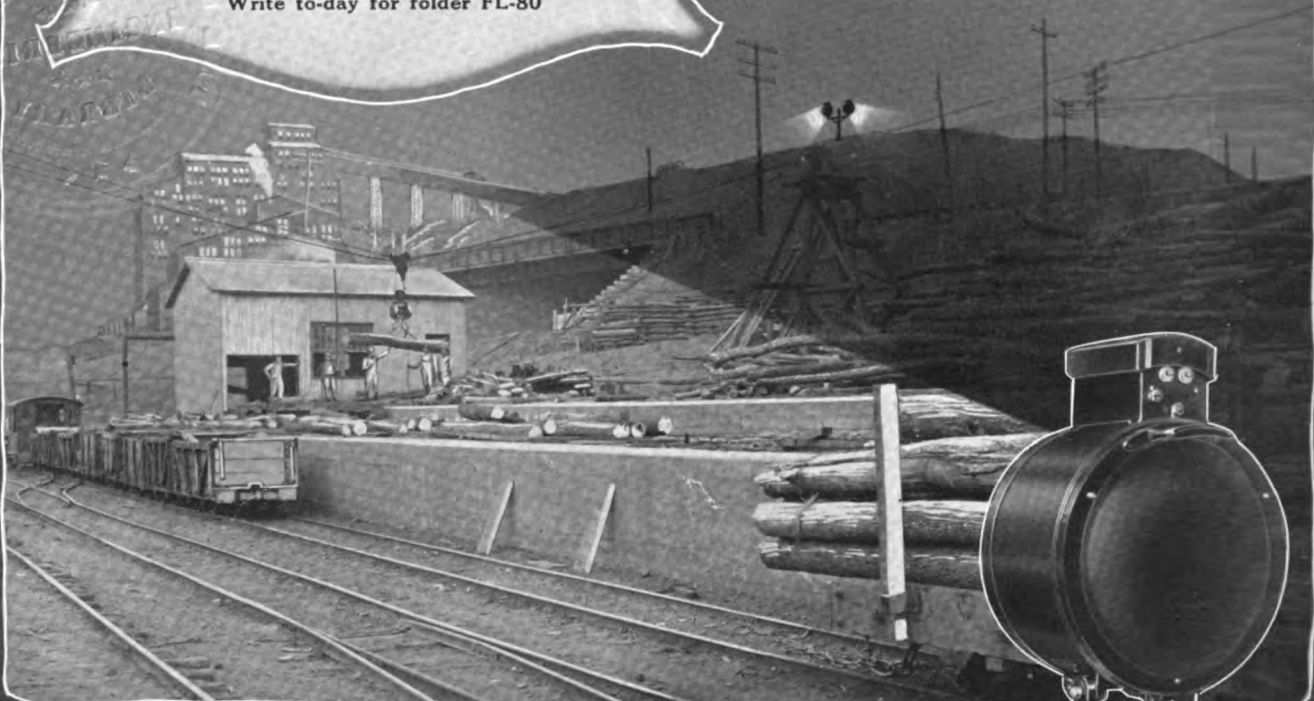

PORTABLE TYPE

Western Electric Company

INCORPORATED

New York	Atlanta	Chicago	Kansas City	San Francisco
Buffalo	Richmond	Milwaukee	St. Louis	Oakland
Newark	Savannah	Indianapolis	Dallas	Los Angeles
Philadelphia	New Orleans	Detroit	Houston	Seattle
Boston	Birmingham	Cleveland	Oklahoma City	Portland
Pittsburgh	Cincinnati	Minneapolis	St. Paul	Omaha
			Denver	Salt Lake City

EQUIPMENT FOR EVERY ELECTRICAL NEED

Member Society for Electrical Development. "Do it Electrically"

An Advertisement Used in a Recent Issue of *Coal Age*

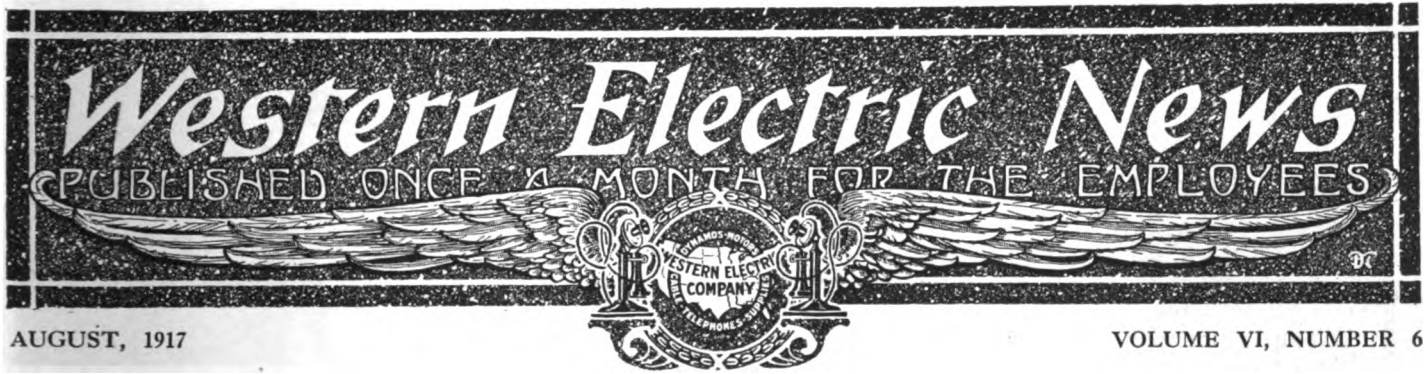

Military Service and Exemption

WHERE it has seemed that our employees could render distinguished service to the Government, the Company has gladly made it possible for them to enter Government service.

Where it has seemed probable that the service which other employees could render directly to the Government would be of equal value to what they could indirectly render in our service, the Company has placed no obstacle in the way of their enlistment.

On another page appears a list of 636 employees who either have already been called into service, or, as members of the National Guard, Naval Militia and various reserves, are subject to call.

From within the ranks of the Company two complete companies of the Reserve Signal Corps of 78 picked men each, specially qualified for designated services, are in process of formation. This represents a total of 792 employees in the service of the Government, or enlisted for such service. The Company is furnishing, therefore, in number, considerably more than its quota, while a large proportion are specially trained men.

The Western Electric Company performs an essential function in National service. It manufactures and distributes its own products and those of others to the telephone, telegraph and other public utility companies. It is now manufacturing and furnishing to the Government articles of great military value. As the war proceeds, the direct demands upon the Company from the Government will increase, and there will be demands which cannot be disregarded from our allied houses abroad for equipment to be used by the Allied armies in the field. It is to conserve our resources for these purposes that we have made representations to the United States military authorities, and shall continue to make them, in the effort to retain in our service those whom we believe can do better national service in the work for us, for which they are specially qualified, than in military service, for which they have no special qualifications.

A handwritten signature in dark ink, appearing to read "W. A. Sawyer", is written over a light background.

President.

Our Radio Companies

One From Hawthorne—One From the East—They Will Soon See Important Action

THE Western Electric radio or field telegraph companies—one from the East and the other from Hawthorne—are fully recruited and ready for further training. Already some of the officers have gone into the Signal Corps Reserve Camp for intensive training.

What a Radio Company Is

Not all of the readers of the NEWS may know that a Radio Company is a part of a field battalion and that its duty is to maintain communication by wireless telegraphy between the headquarters of an army division and the advance cavalry on one hand, and the general headquarters of the field army on the other hand. Under the present organization a company is composed of four radio pack sets transported on mule back and one radio cart set.

A Radio Company is commanded by a Captain and is composed of the following personnel: A Captain and two First Lieutenants, mounted.

The enlisted men are a Master Signal Electrician, technical expert of the radio company, in charge of making repairs and adjustments to wireless telegraph apparatus.

Six Sergeants, first class; one assists the Captain,

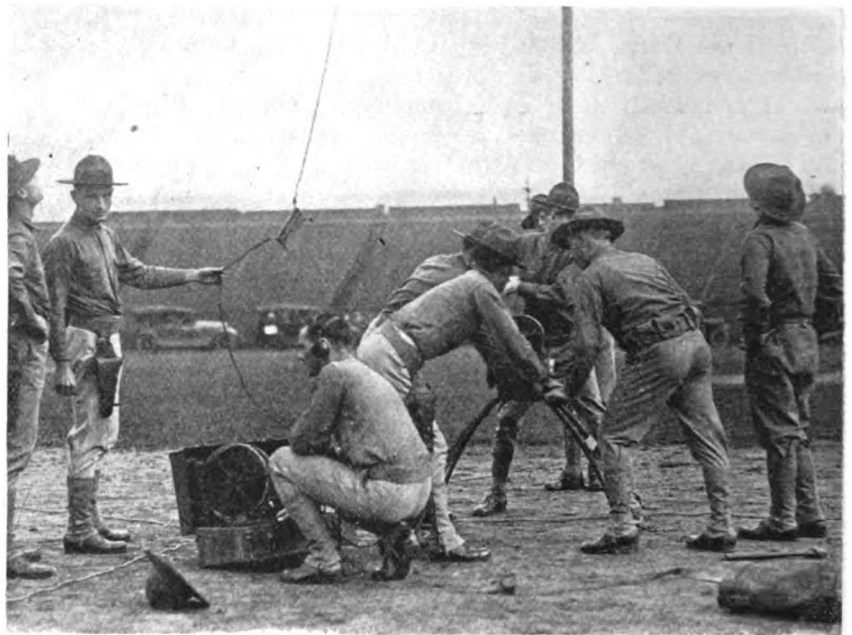

Copyright, Underwood & Underwood

It Takes Just a Little Over a Minute to Set Up a Portable Wireless Set—But You Must Hurry

handling questions of supplies, finances, etc., and five radio operators acting as leaders of the five sections of the Company.

Nine Sergeants—a Supply Sergeant, a Stable Sergeant, a Mess Sergeant, one Engineer for the gas engines and five acting as first assistants to section leaders.

Fifteen Corporals, one Farrier, one Saddler, one Company Clerk (office work), two Mechanics (miscellaneous repair work) and ten Operators assigned to sections.

Thirty-five Privates, first class; two Trumpeters, two Drivers and thirty-one Privates assigned to sections. Six Privates, one Horseshoer and two Cooks.

All are mounted except one Mess Sergeant, two Mechanics and two Drivers. The arms carried are automatic pistols.

Wireless in Trench Warfare

Wireless telegraph in one form or another is often the only communication that can be maintained during bombardments, so that its use has spread into the very front trenches, and portable sets have been developed which can be carried by men detailed from attacking parties to report back the progress of

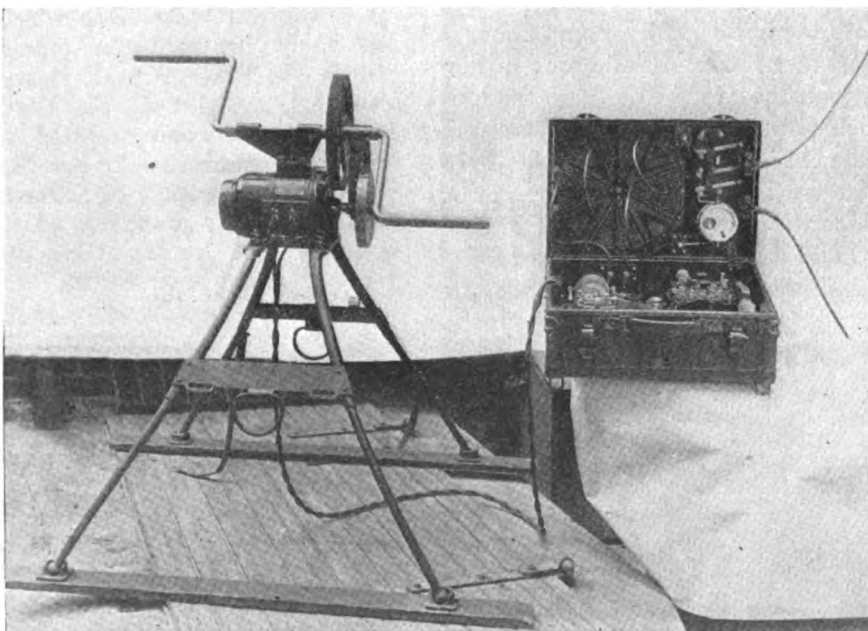

Close-Up View of Pack Set and Hand-Driven Generator. This Wireless Apparatus Has a Range of 25 Miles and Is Used on the Battlefield



the attack and direct the supporting artillery fire.

Previous to the present war the General Staff of the United States Army, in common with that of most other armies, planned the organization of their signal service on the basis of open field warfare, such as was carried on in the present war up to the

battle of the Marne, and the organization and duties prescribed for a Radio Company in the manuals are still such as bear principally upon such a campaign. However, the development of radio wireless telegraphy has been so rapid and the conditions of trench warfare have so changed pre-conceived ideas of the functions of signal troops, that it is probable that the Signal Corps of the American army in France, and particularly the Radio companies, will have to undertake, in addition to their present prescribed duties, new and novel services requiring kinds of equipment different from that already in use, and perhaps changes in internal organization, as well as in their relation to other branches of the army.

Staff Capacity a Possibility

It is quite possible, for example, that the use of wireless and wire telephones and telegraphs will be so extensive that the Signal Corps will have to act in a general supervisory or staff capacity, as well as in their present capacities; that is, beside their present duties they will have to educate large numbers of men in the other branches of the service in the use of signal corps instruments, and oversee their use, acting as a storekeeping and maintenance department for this class of apparatus for all branches of the service.



Erecting the Mast for a Tractor Set—Wireless Telegraph

Naturally, the Western Electric Radio companies will be exceptional in the class of personnel, being composed for the greater part of men with considerable technical experience, who are expected to develop into first-class signal men in very much less time than does the ordinary recruit.

Intensive Training

The commissioned officers of the company will attend intensive training courses which are being provided for signal officers by the Signal Corps of the Army, that of the Eastern Department being located at Monmouth Park, N. J., not far from Long Branch. A thirteen weeks' course is proposed, which is intended to perfect these officers in all of their duties. In the meantime the enlisted men of the companies will receive a course of instruction during certain hours of the day, which, with drills three or four times a week, will prepare them for their work later on, so that when the company goes into active service it will take but a very short time to perfect the organization and training. Some time in the fall the Western Electric Radio Company should be ready to take the field in earnest.



Copyright, Underwood & Underwood

A Wireless Outfit on Exhibit at a Recent Military Tournament in New York. This Sort of Hand Generator Will Be Used by Our Radio Companies

Hawthorne Company is Banner Company of the Second Illinois Infantry

COMPANY B, of the 2nd Illinois Infantry, N. G., called into Government service by President Wilson's recent proclamation, is "the Western Electric Company" of the Illinois units. It contains 40 Hawthorne men, including the captain, T. R. Hudson.

At the time the Federal oath was administered to National Guard members, under the national defense act, the *Chicago Herald* said of this company:



Capt. T. R. Hudson Talking Through One of Our Telephones in Texas

"In signing under the national defense act with a full peace strength of sixty-five men and three commissioned officers, Company B, of the Second Illinois Infantry, became last night the first company of Illinois National Guardsmen to become members of the National Guard of the United States. This company also holds the distinction of winning many important prizes and medals offered last year by the regiment at shooting and athletic tournaments."

As a matter of fact the company has won all the prizes in the regiment for shooting, drilling, athletics, and attendance. It has the best record of attendance in the State of Illinois for the last two years.

Hawthorne men in Company B are: Capt. T. R. Hudson, Lieut. H. G. Pierce, William Davidson, Frank M. Mitchell, George Clark, Wayne N. Bloomfield, John J. Ness, Ernest F. Turvill, Harry J. Tache, Otto Weber, Chas. H. Barson, Jack Ness, William Rude, William Gurke, William T. Horrigan, George Tobias, Silas E. Warren, Maurice E. Way, Chas. S. Allen, Joseph H. Bell, Harold Clarke, Mark M. Dunne, Armin L. Gralps, Alfred Gurke, Walter Meling, Fred A. Meilke, Herman E. Mozer, Gail A. Pittman, John L. Ripkey, Ralph A. Spencer, Albert P. Schlottag, Frank Ton, Joseph Vanecek, Michael Komorowski, Charles D. Drnek, Robert G. Hagen, Harry L. Valance, John R. White, Joseph Grogan, Maurice Demsey.



Company B at San Antonio, Texas

Former Hawthorne Boy in Egypt

THE following letter to a friend, written by Stewart Grant, recently a student at Hawthorne, describes outpost life in the desert 700 miles from Khartoum:

Zalengie, 10-3-17.

"My last letter, I believe, was written at Mallum, en route for this place. Arrived here all safe and sound on February 17th, at last getting to the end of my long journey, which started at Cairo on December 18th, and had included about 40 days on a camel, doing about 20 miles a day, or 3 miles per hour—rather a paralytic affair. Had quite good sport on the journey—shooting a number of gazelles and some Jackson hartbeest (managed to get in a right and left at these) which are about the size of large cows.

This is rather a desperate spot, as I think I told you. I'm several days from the nearest white man; no telegraph; no doctor—and my only communication with the outside world is by post runner who turns up every eight or ten days, provided he doesn't get knocked on the head en route. What papers, etc., drift in here by the mails are about two months old, so I'm somewhat behind the times. Last thing I heard of was that U. S. A. had severed relations with the Huns. Any chance of her declaring war, I wonder!

Saw some lions down by the water, a quarter of a mile from this camp, the other evening. Didn't have a rifle with me; even if I had I should have hesitated to shoot, as a lion and lioness with four half-grown cubs are things to be treated with respect. However, I've been down with a rifle the last couple of evenings to wait for them, but, so far, no luck.

I'm hard at work building mud huts before the rains start, which will be in a month or two; hope to finish just in time. Hyenas are thick around the camp; one almost got my donkey the other night. I've sat up for them once or twice, but have never got a shot in so far; they're beastly things and the noise they make is horrible. Of course, news is scarce in a place like this, and I can see my letters reduced to the size of a telegram soon."

I'll write again when some news does turn up, and, until then, kindest remembrances to you all, and again ever so many thanks for my Xmas hamper. The plum puddings are top-hole.

Yours sincerely,

(Signed) STEWART GRANT.



BOARDING ON THE BORDER

Here is one of Uncle Sam's typical boarding places for his soldier boys—except that they do not all have the beautiful mountain background. The photograph shows the 64th U. S. Infantry's quarters at Fort Bliss, El Paso, Texas. A No. 1-D switchboard for this encampment was recently shipped from Hawthorne.

Western Electric Men Holding Commissions

<i>Name</i>	<i>House</i>	<i>Rank</i>	<i>Organization</i>
Jewett, F. B.	N. Y. Engineering	Major	Signal Officers Reserve Corps
Slaughter, N. H.	N. Y. Engineering	Major	Signal Officers Reserve Corps
Arnold, H. D.	N. Y. Engineering	Captain	Signal Officers Reserve Corps
Craft, E. B.	N. Y. Engineering	Captain	Signal Officers Reserve Corps
Jones, R. L.	N. Y. Engineering	Captain	Signal Officers Reserve Corps
McGrath, M. K.	N. Y. Engineering	Captain	Signal Officers Reserve Corps
Kick, J. A.	195 Broadway	Captain	Signal Officers Reserve Corps
Brinkman, P. P.	Hawthorne	Captain	Signal Officers Reserve Corps
Buckley, O. E.	N. Y. Engineering	First Lieutenant	Signal Officers Reserve Corps
Curtis, A. M.	N. Y. Engineering	First Lieutenant	Signal Officers Reserve Corps
Dobson, G.	N. Y. Engineering	First Lieutenant	Signal Officers Reserve Corps
Hagar, L. A.	N. Y. Engineering	First Lieutenant	Signal Officers Reserve Corps
Howk, C. L.	N. Y. Engineering	First Lieutenant	Signal Officers Reserve Corps
Pratt, G. C.	195 Broadway	First Lieutenant	Signal Officers Reserve Corps
Welles, Paul	New York	First Lieutenant	Signal Officers Reserve Corps
Calloway, A. J.	San Francisco	First Lieutenant	Signal Officers Reserve Corps
Greig, J. A.	Hawthorne	Lieutenant	Signal Officers Reserve Corps
Pratt, H. S.	Hawthorne	Lieutenant	Signal Officers Reserve Corps
Hudson, T. R.	Hawthorne	Captain	National Guard
Alloway, F. L.	Hawthorne	First Lieutenant	National Guard
Hagan, R. G.	Hawthorne	First Lieutenant	National Guard
Vickery, E. W.	Hawthorne	First Lieutenant	National Guard
Goodwin, A. W.	Hawthorne	Second Lieutenant	National Guard
Pierce, H. G.	Hawthorne	Second Lieutenant	National Guard
Lawson, C. K.	Dallas	Second Lieutenant	National Guard
Greene, P. W.	Chicago	Captain	Quartermasters' Res. Corps
Childs, H. D.	Hawthorne	Ensign	U. S. Navy
Guest, D. C.	Chicago	Lieut. Commander	National Naval Volunteers
Forrest, W. S.	Hawthorne	Lieutenant, J. G.	Naval Militia



Some of West Street's Commissioned Officers



Major F. B. Jewett, S. O. R. C. (Chief Engineer)



Maj. N. H. Slaughter, S. O. R. C. (Research Branch)



Capt. R. L. Jones, S. O. R. C. (Transmission Engineer)



Capt. E. B. Craft, S. O. R. C. (Development Engineer)



Capt. H. D. Arnold, S. O. R. C. (Research Branch)



Lieut. G. L. Howk, S. O. R. C. (Circuit Laboratory)



Lieut. A. M. Curtis, S. O. R. C. (Research Branch)



Lieut. Paul Welles, S. O. R. C. (Export Dept.)

Hawthorne's Flag



Asst. Genl. Supt. Bancker Accepting the Flag on Behalf of the Management

UNCLE SAM is such a square, whole-hearted, generous, lovable old fellow that he never has reason to complain of lack of devotion from his numerous nephews and nieces, even when they are only relatives by adoption. At the Hawthorne Works we have a large number of foreign-born employees, but we yield precedence to no body of workers anywhere in faithful, every-day loyalty to Uncle Sam, especially now, when he is in trouble. We show it practically, every one of us, by sticking just a little closer to the job. But

we show it visibly too. You cannot enter a section at Hawthorne that hasn't a large, beautiful American flag suspended from the ceiling. Not flags donated to the departments' workers by somebody else. Every one was bought by the employees themselves, and they are for that very reason the more proud of them. Most of these flags were unfurled with appropriate ceremonies, which were very imposing in some of the larger departments, as the accompanying photographs show.

But gratifying as these local events were, a feeling soon sprang up that the Hawthorne employees as a whole ought to get together in a general expression of their patriotism. As the sentiment grew the Hawthorne Club took the matter in hand for the employees, and arranged the details for the purchase and raising of a Hawthorne employees'

flag. Lest any one should consider his mite too small to be acceptable the envelopes for receiving subscriptions set a maximum limit on contributions of 25 cents. Everybody was to be represented in this flag.

Everybody was. The Works have never before seen such an assembly as gathered to see Hawthorne's flag unfurled at 5:15 the evening of July 12th. People swarmed over the athletic field, on the freight cars and on the roofs of the adjacent buildings. Color was given to the scene by detachments of U. S. infantry, cavalry and naval forces, the Spanish War veterans of the Hawthorne Works, and the Choral Society, in red, white and blue hats. The naval detail was in charge of Pharmacist's Mate Gray, the youngest Spanish-American War veteran now in the United States service, and the flag was raised by First Class Machinist's Mate "Bill" Elliott, the oldest Spanish-American veteran still in active service.

While the Works Band played "The Star-Spangled Banner" "Old Glory" climbed the hundred feet to the top of the white mast, gradually unfolding and shaking herself free in the breeze, gracefully and beautifully, just as if



Long May It Wave!

she had been rehearsed. But then the good old flag doesn't need any rehearsals in doing the right thing! She's been brought up to it.

After she reached her proud place at the top of the mast the Choral Club led in singing the national anthem, following which Rev. J. Ladd Thomas, pastor of the Austin M. E. Church, led in prayer.

J. C. McDonnell, the Hawthorne employee longest in the service of the Company, presented the flag to the Works management. As Vice-President and General Superintendent Albright was unexpectedly called to New York, Assistant General Superintendent J. W. Bancker accepted the flag on behalf of the management.

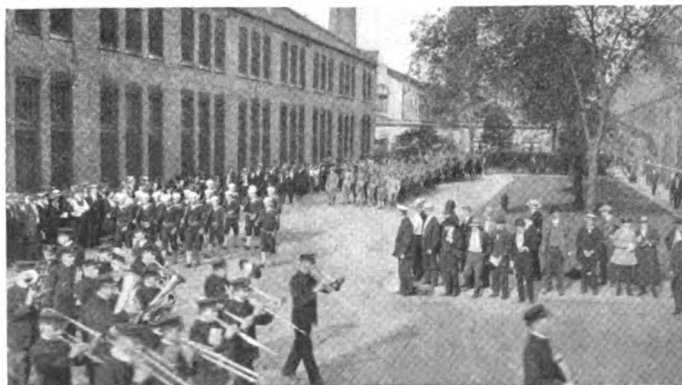

Military Detachments and the Works' Band Marching to the Flag-Raising Ceremonies

The ceremony closed with the singing of "America," after which the audience remained in place while the military detachments passed in review.

H. G. Dean, chairman of the committee on arrangements, acted as master of ceremonies. The other members of the committee were: H. E. Quigley, J. M. Stahr, K. E.



The Hawthorne Repair Department Gathered for Their Flag Raising

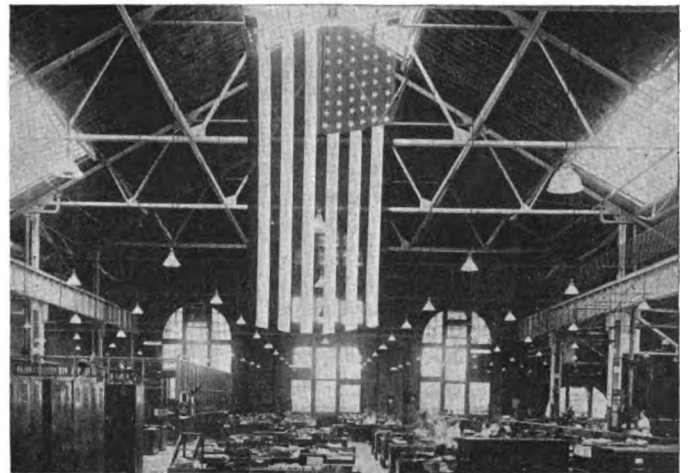

The Big Flag in the General Merchandise Department, Hawthorne

Sutherland, W. P. Randall, J. Harper, E. C. Higgins, C. E. Jahn, C. B. Barnes and Miss Julia Espe.

War News From Paris and London

"London is rather remiss with news, but we must make up for it after the war," writes H. Barnett, News Correspondent in London, when he was asked for "the news." "I must plead pressure of work as the excuse, whereas before the war I had about ten men in my department there is now only one left and he will be joining up before the month is out, I expect. The girls, however, have done splendidly.

"The 'Zepps' now fail to keep one awake o' nights. Instead we occasionally have the order over the telephone 'take air raid action,' and the people in the offices and factories take up their allotted places in the basement except a few who stand by at their posts in case of emergency. Last week we had the unique experience of knowing (after it happened) that a stiff air fight had taken place

immediately over our heads for a short time. I don't see the advantage gained by Fritz in bombing London. People merely stiffen their backs and say 'carry on.' A friend of mine has his daughter, a girl of about eighteen, as his stenographer in town. During the last raid she received a nasty cut across the eye, necessitating its removal. The whole of the day this girl was more concerned about how the office boy got on than about herself. The bearing of the people here is as wonderful as the Huns' methods of waging war are despicable.

"Mr. Thayer's message in the May number was splendid. Needless to say, we are all enthusiastic about Uncle Sam's entry into the ring. We know his coat is off and sleeves tucked up and it is certain that the termination of the war is being brought nearer."

8^e ANNÉE — N° 26

Avril - Mai 1917

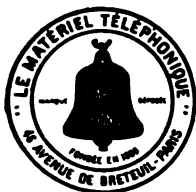

Le Matériel Téléphonique

Société Anonyme au Capital de 5.000.000 de Fr

46, Avenue de Breteuil, PARIS (7^e)

BULLETIN DE GUERRE

The War Paper Published Monthly by Our Allied Paris House; Below, Its Roll of Honor—Employees Who Have Been Killed in War

Fiquet
Verlhac
Typret
Bodart
Forrichon
Gueidan
Remy
M. Gastel
Rousselot
Chantier
Marion
H. Jeanneret
F. Audouard

A. Toulon
G. Duvioux
Burney
P. Deroche
J. Dufraisse
G. Duval
U. Piffet
L. Caryn
Ernest Labolle
R. Brossard
Dallere
Grieffenberg
M. Jarry

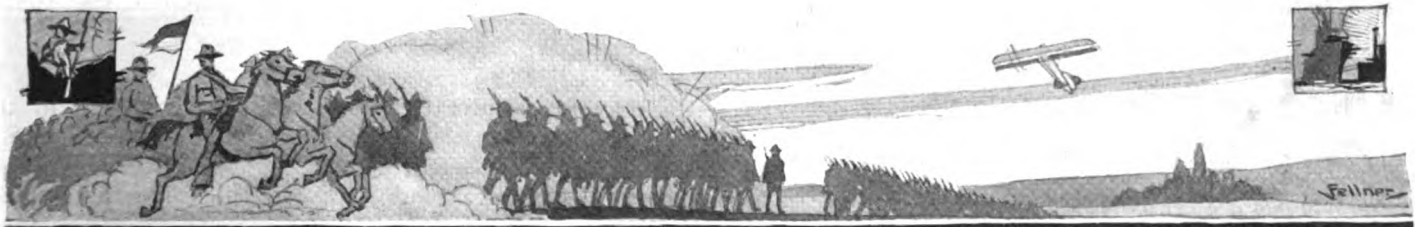

War News from Canada

Casualties, List and Military Honors Awarded Speak for the Patriotism of the Northern Electric Company

THEY have long known just what war is—the Canadians. Hundreds of thousands have gone overseas to fight in France and Belgium. Over 220 employees of the Northern Electric Company have volunteered up to July 1st. Of these, 14 have been killed and 32 wounded or taken prisoners. The News is glad of the privilege of detailing the following military honors awarded to Northern Electric men:

H. E. Wilkinson, Department No. 50, who volunteered for active service on August 27, 1914, to operate Lister Sets, has been awarded the Distinguished Conduct Medal. The official dispatch taken from the *Montreal Gazette* reads as follows:

Gunner H. E. Wilkinson, 1st Brigade Artillery, for his gallant conduct and devotion to duty, particularly on the 8th and 9th of May, near Ypres. Acting as a telephonist he kept up communication with the brigade and infantry headquarters under very heavy shell fire and showed great courage and resource.

R. D. Harkness, of our Wire and Cable Sales Department, Montreal, was awarded the Military Cross. Mr. Harkness enlisted on April 29, 1915, as a private in the 5th Mounted Rifles, gained his commission on the field and was attached to the Yukon Motor Machine Gun Battery in the early part of 1916. The newspaper account of the action for which he was awarded the Military Cross is as follows:

Lt. Robert Dickson Harkness, machine guns, in a daring raid on the enemy's trenches handled a machine gun with marked ability. Later, although suffering from shell shock, he effected a withdrawal of his guns and carried a wounded man to safety.

Eber F. Lough, a salesman of our Regina Office, who volunteered for active service on October 1, 1915, and went overseas in December, 1915, as a private in the 79th Cameron Highlanders of Winnipeg, has been awarded the Military Medal and sent to England to qualify for a commission.

The valor of Thomas Mitchell, a Northern Electric man, was recently reported in the *Montreal Daily Star* as follows:

Not all the heroes of the Canadian Expeditionary Force win decorations, although the list is a magnificent one. There are men who have done their bit and have been wounded, and yet have gone back again and again to "carry on." Such a one is Sergt. Thomas Mitchell, of the First Canadian Contingent, whose name now appears in the casualty list for the FIFTH TIME. He is reported as missing after taking part in a charge. Sergt. Mitchell is twenty-one years of age. He was first wounded in April, 1915, and gassed. After spending some time in an English hospital, he went back again, only to be wounded in the leg and back. He had another spell in Blighty and once more returned to his battalion.

The next fight he was in he got what he described as a "glory mark," a piece of shrapnel striking him on his nose. During his period of convalescence he acted as gymnasium instructor at Aldershot and was offered his discharge and passage back to Canada. But Sergt. Mitchell would not accept it—he once more went back to the firing line, and formed one of an entrenching column which went out on September 26 to clear the enemy from a position. He never came back—in fact, only about eighty of the men ever did.

The father of Sergt. Mitchell is also on active service, being Piper Thomas Mitchell, of the Highlanders, and he was a mile and a half away from his son. Sergt. Mitchell was previously employed in the Northern Electric Co., and was a clever lightweight boxer. He formerly belonged to the Victoria Rifles, and enlisted at the outbreak of war.

Signaller Fred Skelcher, of the Northern Electric's Printing Department, has been awarded the Military Medal for distinguished conduct on the field. Fred Skelcher enlisted in the Royal Canadian Field Artillery in February, 1916, when only 17 years of age. He passed his 18th birthday while training in England and his 19th birthday at the front in France. His father, Thos. H. Skelcher, Chief Clerk of the Accounting Department, has received the following official report of his actions:

"Near Vimy on the night of May —, this man was sent out alone (as no other orderlies were left) at 12:50 A. M. with important and urgent operation orders for the four batteries. At the time the enemy were shelling very heavily with gas shells and also with H. E. and shrapnel. He safely delivered the orders to three batteries and was on his way to the fourth when he was wounded in the head and stunned by a piece of shell. When he came to, he managed to find his way to the fourth battery, and to deliver his orders seven minutes before the zero hour. He was then evacuated. This man's sole idea, in spite of his serious wound, was to deliver his orders, and he showed great courage and determination in doing so."

Fred Stanley McPherson, of the Installation Department, who volunteered for active service on September 8, 1914, was awarded the Military Medal on June 3, 1916, and was promoted Lieutenant on June 20th.

The services rendered by Lieutenant McPherson, and for which the decoration was awarded to him, were not mentioned in the official *Gazette*, but we received the information from the Department of Militia and Defense, Ottawa, in a letter written by the Adjutant-General.

The Northern Electric's Roll of Honor

R. O. Bremner, Montreal, Lance Corporal. Died of Wounds January 29, 1916.

John Brown, Montreal, Private. Died of Wounds June 9, 1917.

H. D. Browne, Montreal, Lieutenant. Killed July 18, 1916.

William Burns, Montreal, Private. Killed July 19, 1916.

Stephen Gowans, Montreal, Private. Died of Gas Fumes May 19, 1915.

Carlton B. Hawley, Montreal, Private. Killed April 27, 1915.

Wilfred Harrison, Winnipeg, Private. Died of Wounds May 3, 1915.

William Kalabza, Montreal, Private. Killed May 5, 1915.

William E. Mawson, Toronto, Private. Killed July 20, 1916.

A. Morris, Montreal, Private. Killed April 24, 1917.

Fred Smith, Montreal, Private. Killed in action June 13, 1916.

T. Thomas, Montreal, Private. Killed April 24, 1917.

C. R. Wolferson, Montreal, Private. Killed in action June 19, 1916.

H. T. Walker, Montreal, Private. Killed in action June 20, 1916.



Fred Skelcher

We Have a Military Wedding

HAROLD H. CLARK, of the apparatus service section, General Merchandise Department, was married recently to Miss Jessie Aldrich—but not to get out of the draft. No, indeed. For Clark joined Company B, 2nd Infantry, Illinois National Guard, the Saturday before his marriage and was accorded the honor of a military wedding at his company's armory.

Guardsman H. G. Gill, of the stock maintenance section, played the wedding march, while 500 soldiers stopped drilling and stood at attention as the couple advanced under an archway of crossed bayonets, formed by a military escort composed of Privates Bell, Norton, Horrigan, Schrader, Perry and McMahon. The ceremony was performed by the Rev. Geo. W. Grey, of the Congregational Church of Downer's Grove, Illinois. Captain T. R. Hudson, of department 5059, acted as master of ceremonies, with Miss Harriet Heinz as bridesmaid and Walter Drew as best man. Lieut. Vickery, of department 5958, presented Mr. and Mrs. Clarke with a beautiful set of cut glass, the gift of the "boys of Company B."

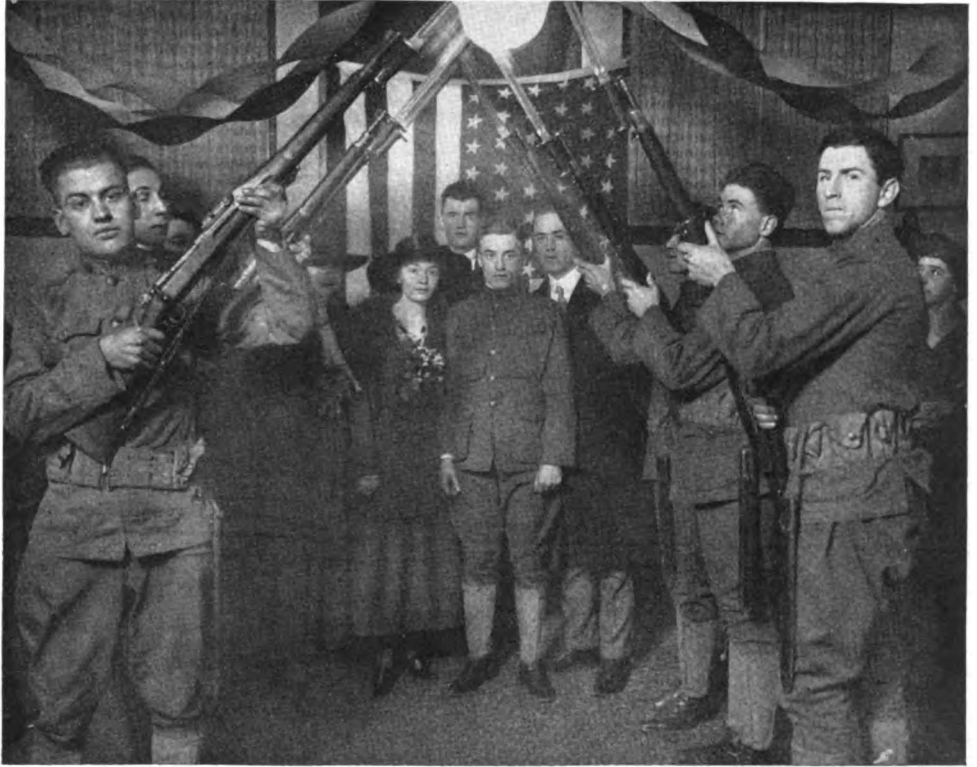

OUR FIRST MILITARY WEDDING ON RECORD

Harold H. Clarke, of Dept. 5907, Hawthorne, Bridegroom and Soldier

Old News Correspondent Now Aviator

THIS is a picture of Captain Gerald Jacques, of the Royal Flying Corps (British Army), formerly a member of the Western Electric Central Engineering Department at Antwerp and one time war correspondent to the WESTERN ELECTRIC NEWS. In the fall of 1915 Mr. Jacques obtained his commission as 2nd Lieut. in the Wireless Section of the Royal Flying Corps. His achievements, so far, may be judged by the fact that, under date of November 13, 1916, he was mentioned in the dispatches for "distinguished and gallant services." These services were promptly rewarded when, on December 1, 1916, he was made 1st Lieut. and Equipment Officer of his unit. On the 21st of May, this year, he was promoted to the rank of Captain.



Captain Jacques

A Trio of Installers in Khaki



W. E. Caldwell



E. J. Bills



E. E. Allan

Last Minute Military News

C. L. Huyck Bulletins in Some Special "War Correspondence" from San Francisco

In First Lieutenant Allan J. Callaway we have the only Western Electric man to be appointed as an officer of the A. T. & T. Telegraph Battalion. He is now located in the Monterey encampment, where he is acting as Supply Officer of his battalion. Lieutenant Callaway's experience stands him in good stead, for he was Major of the Colorado State College's Cadet Battalion in his senior year. He has also served two enlistments as Sergeant in the Colorado National Guard.

Gustave Moller finds his comrades "a fine set of fellows," writing from the Naval Reserve Training Station at San Pedro.

Roy Dryer and Ray Welch have also enlisted in the Submarine Chaser service, as full-fledged "catch-em-alive-o's."

W. H. Johnson is a First Lieutenant in the Signal Reserve and will impart a Yale polish to his duties.

The Field Artillery has claimed H. D. Bradford as a Non-Com. His record includes a four-year service in the Missouri National Guard.

H. L. Sterrick has re-enlisted in the Navy as an electrician.

From the Emeryville Shop (besides several applications unreported to date), G. Williams and R. W. Browne have enlisted in the United States Medical Corps for Field Ambulance Service, and W. T. Vervais has joined the National Guard, Sacramento Company.

F. M. Powers, erstwhile a "jit" delivery driver of the Oakland Store, is now a U. S. Engineer, and perhaps will shortly be a staff chauffeur "Somewhere at the Front."

E. F. Rahair, of the Portland Central Storeroom, has enlisted in the Army; C. R. Tucker, of the Los Angeles Central Storeroom, in the Navy.

Employees Who Are Members of Military Organizations

	Total
U. S. Army	6
U. S. Navy	5
National Guard	399
Naval Militia	24
U. S. Marine Corps	2
U. S. Army Reserve	21
U. S. Navy Reserve	2
National Guard Reserve	49
Naval Reserve	46
Naval Coast Defense Reserve	8
Naval Volunteers	11
Signal Officers' Reserve Corp.	18
Reserve Signal Corps	157
Quartermasters' Reserve Corps	2
Reserve Corps of England	4
Enlisted Reserve	1
Red Cross Base Unit	7
Reserve Officers' Training Camps	30
Aviation Section—Signal Corps	2
Army Y. M. C. A.	1
Ambulance Corps	2
	<hr/>
	792



Atlanta Employees in Officers' Training Camp at Fort McPherson, Ga. Left to right: J. G. Mason, H. P. Full, E. C. Whitehead, B. Kaufman

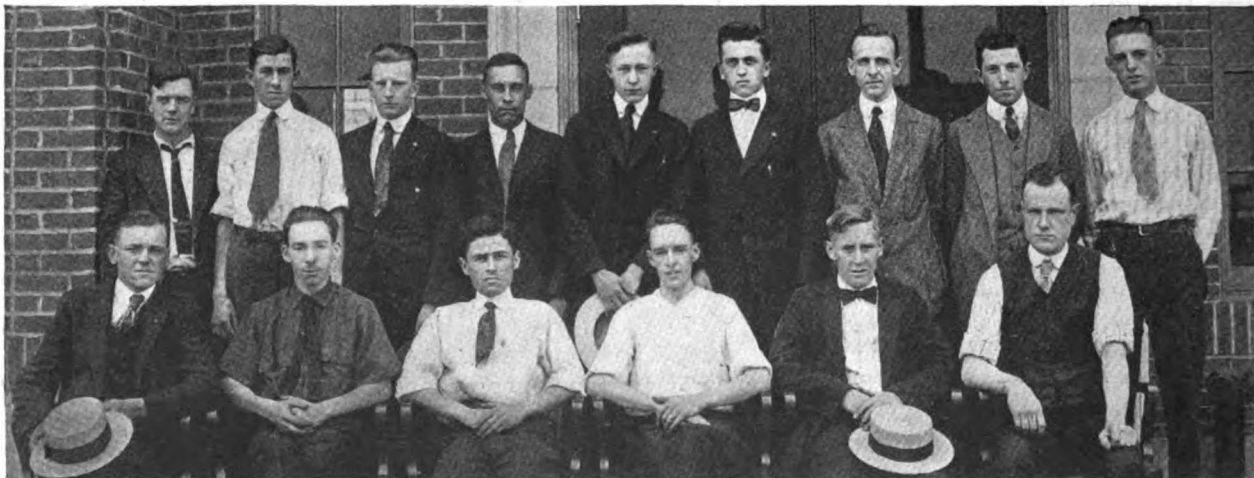

EMPLOYEES OF THE BOSTON HOUSE WHO HAVE ENLISTED FOR ARMY OR NAVY SERVICE
 Back Row (left to right): J. J. McCarty, J. T. Fadel, H. Cairnie, D. Osborn, E. Patterson, C. Neilson, E. B. Clark, C. Noyes, R. Eaves. Front Row (left to right): W. G. Haynes, D. W. Collum, A. A. Harris, T. J. Major, Jr., P. J. Flanders, A. H. Perkins

Lord Northcliffe's Visit

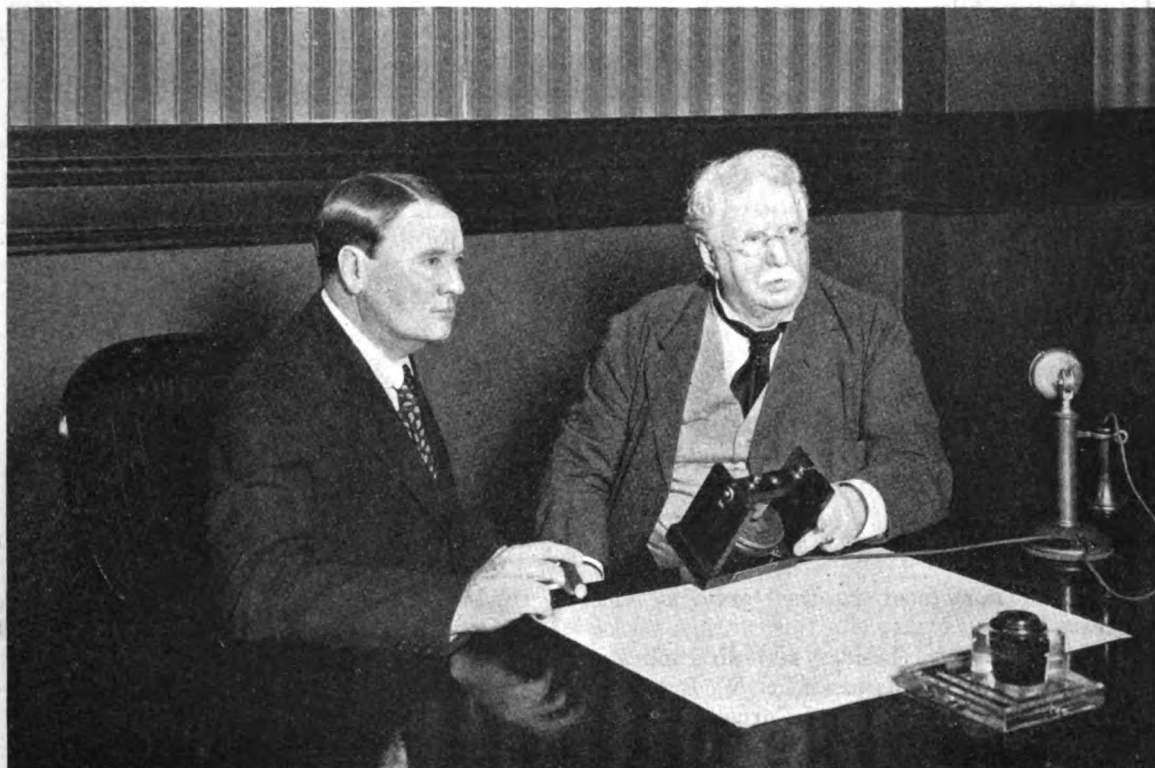

Lord Northcliffe (left) and Mr. Vail (right) at 195 Broadway

ON Thursday, July 12, 1917, the Western Electric Company entertained a distinguished visitor—Lord Northcliffe—whose visit to this country ever since he arrived from England a few weeks ago has been an important source of news for every American newspaper. Lord Northcliffe devoted the entire day to a study of the Bell telephone system. As the guest of Mr. Vail, he enjoyed during the morning a special exhibition of the workings of the transcontinental traffic line. Under the direction of Major J. J. Carty, Chief Engineer of the American Telephone and Telegraph Company, the famous roll call of wire chiefs across the continent was made and connection established with San Francisco with ease. After conversing with friends in San Francisco, and hearing the words and music of "God Save the King" transmitted from a phonograph on the Pacific Coast, Lord Northcliffe viewed with interest a series of motion pictures showing how the transcontinental line was built.

After spending the morning at 195 Broadway the entire party, including Lord Northcliffe, Mr. Vail, Lord Northcliffe's secretarial staff, and a number of the officials of the American Telephone and Telegraph Company, were escorted by President Thayer, Vice-President Halligan and Chief Engineer Jewett to the West Street building. Here a model of the first telephone was exhibited to which was attached a piece of iron vibrating in front of a magnet. Using a modern receiver in one room and the old telephone in another room speech was transmitted and heard in the

modern telephone, although very indistinctly and faintly. Then modern amplifying apparatus was added to the circuit, and the sound from the old telephone, although indistinct, proved loud enough to be heard in all parts of the room. A copy of this old model telephone is now being prepared and suitably inscribed for presentation to Lord Northcliffe by Mr. Vail, as a souvenir of the occasion.

Mr. Vail had already presented Lord Northcliffe with a miniature model, a shade more than an inch long, of the latest form of telephone receiver. It carries a gold plate bearing the inscription "To Lord Northcliffe from Theodore N. Vail." This remarkable little instrument is an exact copy, and most remarkable of all, it works, for Lord Northcliffe himself heard speech through it. It is even capable of transmitting as well as receiving speech, but like the old model, when used for transmitting it needs a little help from some modern telephone amplifying devices connected into the line.

At "463" Lord Northcliffe not only heard speech but saw it, by looking into an apparatus which reproduced in a wavy line of light the motions of the telephone diaphragm. Photographic records of this vibrating beam of light were taken. These records show in visual form the words "Lord Northcliffe," "Vail," "The Times."

Lord Northcliffe saw being conducted in our laboratories life tests on telephone transmitters, on electric batteries, on switchboard lamps and on electrical mechanism of many kinds. The other exhibitions were sections of

modern telephone cables, each containing twenty-four hundred wires enclosed in a lead sheath having an outside diameter of $2\frac{5}{8}$ inches.

The entire party were the guests of the Western Electric Company at a luncheon which was served in the suite of rooms occupied by the heads of our Engineering Department, Mr. Thayer presiding as host for the Company. Among Lord Northcliffe's party were Brigadier-General W. A. White, Lieutenant-Colonel Campbell Stuart, and Captain Paul F. Sise, who is known to all Western Electric people by his affiliation with the Northern Electric Company at Montreal, and to all Britishers in New York because of his official activities in recruiting there.

Besides those mentioned there were present the following officials of the American Telephone and Telegraph Company:

U. N. Bethell, Senior Vice-President; N. C. Kingsbury, Vice-President; A. A. Marsters, Secretary; N. T. Guernsey, General Counsel; C. D. Milne, Treasurer; C. G. DuBois, Comptroller; J. J. Carty, Chief Engineer; B. Gherardi, Engineer of Plant; C. H. Wilson, General Manager; F. A. Stevenson, General Supt. of Plant; J. L. R. Van Meter, General Supt. of Traffic. Of the New York Telephone Co.: F. H. Bethell and H. F. Thurber, Vice-Presidents; and Newcomb Carlton, President Western Union Telegraph Company.



The Medal They Gave Mr. Vail

In Recognition of Forty Years of Service

IN 1877, when there was only a Bell Telephone and no system, the commercial problems involved in the initiation and development of the great public service which has linked together the people of this continent were talked over with Mr. Vail. In 1878 Mr.

PIONEER AND BUILDER Vail commenced his official connection with the corporation organized to undertake that development, and in the years immediately following, under his direction and in accordance with his plans, the foundation for the great business was laid.

Since then, although he has not been continuously officially connected with the System, his watchful thought

COUNSELLOR for its interests has never ceased and his voice has been heeded in council. On April 30, 1907, by election to the presidency of the American Telephone & Telegraph Company, he

CHIEF became the executive head of the System.

Therefore, 1917 marks the end of forty years of won-

derful service, and April 30th marked the end of a decade of his chieftainship.

During that ten years the development of the Bell Telephone System, scientifically and practically, has been the admiration of the world. It is rare that it is given to a man to accomplish and see such a fruition of his own ground work—to see such a wonderful vision of his youth in full realization, the result of his own imagination and foresight, and his own constructive and administrative genius.

That the completion of these periods might not be unmarked, and to furnish an opportunity to wish him success and happiness in years to come, some of his old friends and associates made him their guest for the evening of April 30th, and as a souvenir of the occasion a medal was presented.

The NEWS is glad to be able to show herewith a facsimile.



The Face of the Medal



The Back of the Medal

Swinging Around That Circuit

Part IV:—Some Western Electric Atmosphere on the Pacific Coast

BEFORE you go to the Pacific coast get a Californian to tip you off on the manners and customs of the place. I was fortunate in having Fred Baedecker Leggett help me plan my trip, and warn me what to and what not to say. Fred was our coast manager for several years, and he knows the ropes not only around there, in fact, but all over the world. If you happen to have to take a trip to Senegambia just ask Fred about the railroad connections, and you'll marvel as I did at his store of knowledge. As a result of his coaching never once did I jar the sensitive ear of any native son by a crude "Frisco," nor speak of "the Fire" as "the Earthquake"; and by the observance of these and a few more similar rules my visit was not marred by a single upset.

San Francisco in March was like New York or Chicago in May, with the hotels filled with tourists. In my room at the St. Francis I found "Western Electric Sunbeams" in the sockets, while at night the entire building—the largest hotel in the city—was outlined with thousands of our Mazda lamps. This pleasing evidence that we have a live lamp department in our San Francisco office was later borne out when the said department in the person of L. J. Brown treated me to an 80-mile automobile drive to points of interest in and near the city.

Whole chapters could be written on those places, but what traveler would attempt to describe a sunset from Mount Tamalpais, for instance, when it might rob News Correspondent Charley Huyck's exotic pen from a chance to drip the great gobs of local color stuff that he loves so to spill in his column. No, let *him* tell you of all of those sights from the thousands of acres of artichokes down in the "choke" country, near Half-Moon Bay, to the wonder of the stately redwoods in Muir Wood, with lots in between for good measure.

With such real things to show its visitors the wonder is that San Francisco still is willing to take the shekels from gullible travelers who would be guided through its China-

town which, since it was rebuilt along modern lines after the fire, suffers in comparison with New York's Chinatown for true oriental flavor, and bears none of the far-famed "Barbary Coast" atmosphere which, too, has melted into memory and is being kept alive just now through the medium of the motion picture. From the foregoing you might suppose I was "stung" on my visit to Chinatown. Not so fast, Watson, it cost me for a guide not one yen. Incidentally, the most interesting thing in the place came

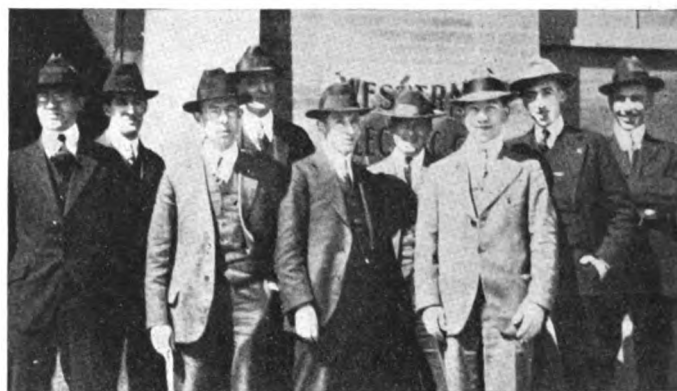

Office sales force and traveling men of San Francisco. No, the salesmen are below—not above. Now you know why they have such a heavy "overhead" expense in San Francisco

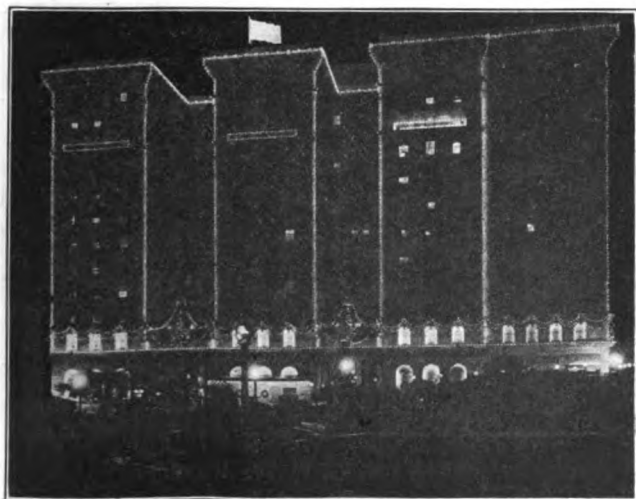

St. Francis Hotel, San Francisco, Outlined by W. E. Sunbeam Mazda Lamps

from Hawthorne; it is the Chinese telephone exchange, which was described fully in the News some years ago.

District Manager E. J. Wallis presides over three establishments in the metropolitan district of San Francisco. There is the Folsom Street warehouse and sales office, headquarters of our business on the Coast. This is the building which survived that fire and earthquake, and it is typical of Western Electric standard warehouse construction. After that disaster you remember the Company headquarters at Chicago received the now historic message: "Our building stands like a monument in a desert—saved by watchmen, water tower and wire glass."

Then at Oakland across the bay is our Oakland store, and at Emeryville, a suburb also lying across the bay, our shop and cable yard. In the three places there are employed about 450 persons. The Emeryville plant on the

mainland has excellent railroad facilities, with a siding onto our property. Much of the bulk shipping is done to and from this point so as to avoid the trucking necessary in the city of San Francisco to Folsom Street. Reference to the Oakland store has but recently been made in the NEWS.

Our Sales Manager W. S. "Bill" Berry is one of the landmarks in our San Francisco organization, but he was absent on a trip to the Hawaiian Islands during my visit. The pictures of his crew in the sales department speak for themselves, but, as Bill himself furnishes no material for this story, he is hereby summoned to write of his travels for a future issue of the NEWS.



They just can't help smiling in Los Angeles. Above, the office organisation; below, the traveling salesmen

If this were not the War Issue of the NEWS I'd like to tell you of that ride down the coast from San Francisco to Santa Barbara, and of the automobile trip for the remaining 100 miles to Los Angeles, but the editor has warned me in advance that this concluding travelogue must be brief and, though believe me, I'm passing up lots better stuff that got by in the first part of the story. "A fella's gotta be a good soldier in a War number, now, ain't 'e?"

Los Angeles "got" me. It's a sort of infection, I guess. Yes, "Andy" Andrews, I do like the climate. The reply's made to you because you were the first of the one hundred and thirty-four people that put that question. And I like your orange groves, and your missions, and your automobile rides, and your easy-going philosophy of life.

But Southern California is a better place to spend a fortune than to make one. And so, for awhile at least, I'm going to stick to my job back East and save up against the

vacation I've promised myself some time in the future, in that wonderland of sunshine.

The boys in the Western Electric organization in Los Angeles are long on hospitality. When an automobile trip was suggested to me I looked out on the street in front of our building where there were about as many cars parked as people in the building. Even the office boy runs a car there. And as for the girls, my old friend Stores Manager O. S. Lair says: They never hire a stenographer unless she runs at least a six-cylinder machine.

For lunch at their club at noon Manager Butts and Credit Man S. F. Gibbs introduced me to the game of dominoes, the greatest indoor sport on the Coast. There in the dining room were fifteen or twenty groups of men eating with one hand and playing with the other. Each man has a little round table at his right on which his food is served, while on the large table in the centre the dominoes are spread out. To such a limit has the spirit of play led the Los Angelan, who "plays while he eats."

Industrially, Los Angeles has no such field as San Francisco. The city's remarkable growth—it now outnumbers San Francisco in population—is almost wholly a residential and tourist development. Fortunes have been made and lost in real estate. Its critics will tell you that Los Angeles is the greatest parasite city in the country—no



The New Type of Houses in San Francisco—With Garages in Basement. Note the Entrances Where the Family Automobile Rolls in and Out

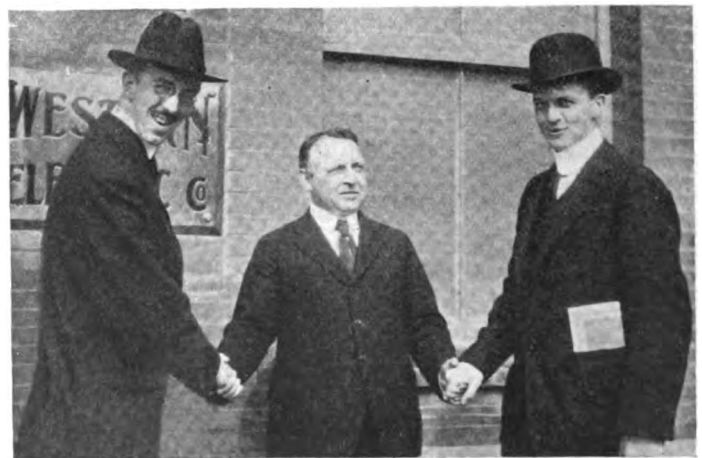

AT THE PARTING OF THE WAYS

D. F. G. Elliott says good-bye to San Francisco, as he leaves for Tokyo. Phil Thomson, Advertising Manager, leaving for New York. The short party doing the honors is Ed Wallis, commander-in-chief of our Pacific Coast business

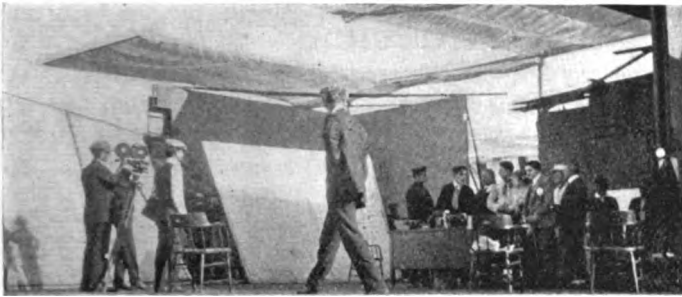

Typical views of the taking of motion pictures. The stage coach scene is from the picture, "Dropped from the Clouds," now being exhibited on the "Universal" circuit

one engaged in productive enterprises, every one living off others.

But to this there is certainly one notable exception, for here has centered the motion-picture industry of the United States and the world. The bright sunshine, the dry air, the long days, and the absence of rain, together with a rare variety of scenery, were nature's contributions to this centralization, and here is an industry of enormous proportions which, among other things, requires four mammoth zoos and more than thirty great studios employing 5,000 people. Here are made 73% of the world's motion pictures. It is estimated that this industry brings \$30,000,000 to Los Angeles annually.

I found "Universal City," the largest place of the kind, a good customer of the Western Electric's, especially in lamps and lighting equipment. At the time of my visit there were fifteen or twenty different motion pictures being taken, both in the "set-ups" on the huge stage and in the open country close by. Movie actors in paint and costume, cowboys, Mexicans, sailors, and men and women of various queer types people the place and give it a peculiar setting. I was fortunate in securing some snapshots of scenes in motion pictures which I have since seen on the screen in New York. "Andy" Andrews, our lamp specialist who knows the motion-picture game backward, is down for a story on it for some future issue of the NEWS.

I found Sunbeam lamps again in the Pullman on the Santa Fé when I started back from Los Angeles on the

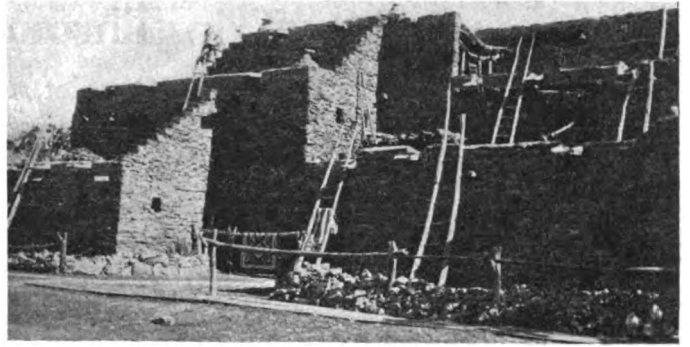

Hopi Indian House at the Grand Canyon Lighted by Western Electric Sunbeam Mazda Lamps

long trip home, and met them again at the Grand Canyon the day I stopped over there. It was in a most unexpected place—the Hopi Indian house on the reservation. There was a curious mingling of the old and the new civilization—Indians laboriously weaving rugs on a hand loom by the light of Western Electric Mazda lamps.

My impressions of the Grand Canyon? Well, you remember old Irvin Cobb's "Roughing it De Luxe"? In it he says that every writer who visits the Canyon says there are no adjectives adequate to describe it, and then they go ahead and try to show that there are. Well, then, I'm going to be the exception, first because I don't know of any terms that are adequate; second, because Cobb himself has done it so well; and, lastly, because my space in the NEWS is exhausted.

These sidelights on our Western Electric distributing houses have, I know, been most superficial. They haven't even touched some of the "high-spots." Perhaps, though, they have served to throw some more light on the conditions under which our men in the field carry on their work among our customers. Certain it is that this department of our business is full of interest and romance, and it is to be hoped that the men in the field will tell the rest of us more about all these things through the medium of the NEWS.



My Trip Through South America

By P. K. Condict, Foreign Sales Manager

(Continued from July issue)

AFTER a few days at Valparaiso I bade good-by to Mr. Mitchell and took a small coasting boat, stopping at several ports on the way north to Antofagasta, still in Chile. After a busy day there I started off the next morning on the Antofagasta-Bolivia Railway, which has the distinction of running a complete train, including sleeping and dining cars, on a thirty-inch gauge track. Starting two days ahead of the regular weekly express it was possible to stop and visit the Chucicamata Copper Mine, another of the mines under American control, which is turning out large quantities of copper. It was particularly interesting to see the work that the telephone is doing in assisting to operate these great mines. On the way up from Antofagasta we passed through the great nitrate fields of Chile, a most desert-like country, but which is the scene now of great activity on account of the amount of this product used in the manufacture of munitions. I caught the weekly express at Calama, the station for Chucicamata, and went on up to Bolivia, a 24-hour run to Oruro. We passed by the reservoir which the railway has built, some 250 miles from Antofagasta, from which source the water is piped to that city and given to the various mining companies and nitrate *officinas* on the way to the coast. We also saw the great borax lakes, but the twenty-mule teams were resting that day.

Oruro is a railway and mining center in Bolivia, with a population of about 30,000. The hotel, like many others in out-of-the-way places in South America, is a place where one would not choose to stay if he had a portable tent which could be erected in the plaza, invariably one of the beautiful features of every South American town. Here I saw for the first time the quaint dress of the Bolivian Indians, the men wearing brightly colored ponchos, and one tribe distinguishing itself from others by having the trousers slit on the side. The women wore straw hats with high crowns, brightly colored shawls and equally brightly colored skirts, which stuck out like those our grandmothers wore. After a day at Oruro I went on to La Paz, the capital of Bolivia. It is a wonderful sensation to travel across an almost level plain and realize that you are at an elevation of more than 12,000 feet above sea level, and to look out of the car window and see mountains in the



NOT A ZOO
But on the Job in Their Real Home—the Famous Llamas
of South America

distance rising to heights over 20,000 feet. After a ride of six hours across this plain we suddenly come to the edge of a canyon and, looking down several hundred feet, see the city of La Paz, a most remarkable and picturesque sight, settled down in this deep ravine, with the red roofs of the buildings shining in the sun.

Bolivia, as you know, is a great mining country, and at the present time there is much activity there on account of the high prices ruling for metals. The country is unfortunate in having no sea coast to assist in moving its products, but there are now three railroads connecting it with the coast, two in Chile, starting at Antofagasta and Arica, and the third one at Mollendo, Peru. Freight is moved extensively in Bolivia and also in Peru on the backs of llamas, the most foolish-looking beasts imaginable, possibly a cross between a giraffe and a fat mule with long hair, their small heads held disdainfully in the air. They carry 100 pounds, rebelling at an extra ounce, and make long marches on the shortest sort of rations. Their hair is used for clothing and rugs.

I went down to the coast by the Mollendo route, crossing famous Lake Titicaca, the highest navigable lake in the world, at an elevation of something over 12,000 feet. A great many people suffer from mountain sickness at these altitudes. If one is seriously ill he is usually rushed down to the coast in a special train where breathing is less of an effort. We crossed Lake Titicaca on a beautiful moonlight night. The next morning we boarded the train of the Southern Peru Railroad and climbed still higher, to an elevation of 13,500 feet, and then commenced the descent. It is claimed that that railroad had been built on contract by the meter, so that there was apparently no great desire to end it. The innumerable curves suffering most of the passengers who were not already suffering from mountain sickness.

Late in the afternoon we reached Arequipa, one of the oldest of the Peruvian cities. It is beautifully situated in a little fertile valley, watered by the snow from the high



The Author

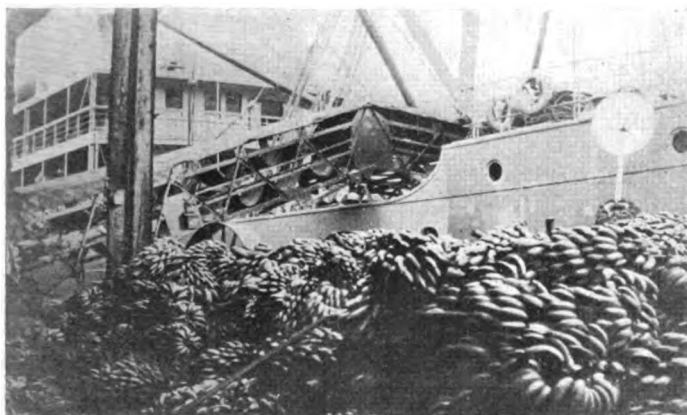

DON'T TELL MR. HOOVER!

But All These Bananas Will Never Be Eaten. The Pile Is Waste

mountain peaks which surround it. Coming down on this trip from La Paz we had seen many ruins of the famous Inca civilization. Next morning it took four hours more from Arequipa to reach Mollendo, always going down a pretty steep grade, until finally we saw the ocean off in the distance and still far below. Practically speaking, there are no good ports on the west coast of South America, and the loading and unloading of vessels are a most difficult business. Frequently, when there is too much sea running, it is impossible to lighten the cargoes and they have to be carried on. The breakage is tremendous. There seems always to be a swell in the Pacific, and our greedy boatman very nearly gave us a ducking by loading the rowboat with passengers and baggage until the gunwale was almost under water. Then we started out for the steamer, lying about a half mile off shore, and safely negotiated the narrow channel where the waves broke high on either side. I was relieved on boarding the steamer to find that my baggage which I had left at Valparaiso was safely stowed in the specie room, after I had searched almost the entire hold in an effort to find it. The Steamship Company had evidently sold two or three times over the reservation which I had made six weeks before, as there were many passengers on board who were sleeping on the deck and in the salons as well as having three or four to a cabin. I finally was allowed a hard leather lounge, about five feet long, in a small stateroom with two other men and a large trunk which took up all of the available floor space. After you are used to it you can sleep almost anywhere, but that is not possible for the first two nights, so I was glad enough to leave the ship at Callao, Peru, and, after a quick inspection of baggage by the Customs, boarded the electric train which furnishes splendid service between Callao and Lima, a distance of about 15 miles.

Lima was the ancient capital for all of the Spanish possessions in South America, and there are still visible many signs of its ancient grandeur. In the big cathedral in the Plaza, on payment of a small fee, the warden will show you the skeleton of the famous Spanish Governor Pizarro, a man of huge frame, whose rule instilled fear and hatred into the hearts of all the people. I was told that they used also, for an additional fee, to exhibit the skeleton of Pizarro at the age of ten. As I was passing through the plaza one afternoon I saw a stand erected in one corner of it and found that the weekly Saturday drawings for the Government lottery were being made—four little or-

phans turning four big globes containing innumerable small balls with numbers printed on them, one of which they finally draw from each of the globes and so decide on the lucky winner. These lotteries are characteristic of all of the Latin American countries and are run by City, State and Federal Governments. A considerable percentage of the ticket money is kept for Government expenses and often used for the support of orphan asylums. In Lima and its suburbs there is a very fine system of tramways, and it is interesting to note that this is one of the very few places in South America where the public utilities of tramway, light and telephone are owned practically entirely by local capital. The telephone service is good but, as in most South American countries, there is no measured service, and the number of calls coming in from hotels and other public places, as well as free toll lines, very nearly swamps the system.

After a week at Lima I again boarded one of the boats of the Chilean Steamship Company. It is remarkable in this part of the Pacific that, although you are right on the Equator, it is generally very cool at sea, due to the cold waters of the Humboldt current flowing up to the coast. In five days, in spite of rumors of German submarines having been built and launched in Mexico, we arrived safely at Balboa, the end of April, and it was there that I first began to realize that we were at war. We were stopped away outside the entrance by a warlike-looking tugboat with impressive guns. A pilot finally took us in through the mine field. As passengers are in quarantine for seven days after leaving a Peruvian port we still had two days before we were free to go where we wished, and I was glad of the excuse to stay on the steamer and go through the Canal rather than to get off and board at the Quarantine Hospital.

The Panama Canal you have heard of continually and seen innumerable pictures of—and I am only going to say here that it is one of the greatest sights in the world and one which can well make every American have a feeling of great pride in the achievement of his country. After a hot night at Balboa and another one at Colon on board the steamer we were discharged from quarantine, and I had an opportunity of going back by rail to visit some of our friends at Balboa and Panama City, and also an opportunity, through the kindness of one of the Government officials, of seeing the power house and the control tower for the Gatun Locks.

After three days in the Canal Zone I took the United Fruit Steamer *Pastores* and we were again escorted out of the harbor through the mine fields, with a pilot on board and a destroyer to point out the way. The next morning we were tied up at Port Limon, Costa Rica, and for 36 hours sweltered in the heat while bananas kept gradually filling the hold of the ship. I have never seen so many bananas. There were more rejected and left on the pier than it would take to delight the hearts of a great many children in some of our big cities. In three days more we were at Havana and, as our valuable cargo of bananas was beginning to ripen, the passengers had to forego the expected pleasure of landing there, as we were in the port less than an hour, and then were racing off to New York, only to reach Sandy Hook three days later, but after sundown, too late to get through the Narrows until the following morning. It was good to be back home again after so much journeying.

HEARD IN THE SHOPS

ACTIVITIES OF THE MANUFACTURING DEPARTMENT AT HAWTHORNE

Who's Who at Hawthorne



Who keeps all Hawthorne spick and span and scrubbed up like your lad when warned: "Now clean up good, young man, or you don't go with dad"? Who heads our firemen bold, that yearn for one good blaze to fight (but, darn it all, the Plant can't burn—the bricks and steel won't light)? Who dyes our grass up nice and green and paints our flowers bright? (Just paste this tip within your bean: "Don't pick them or—Good-

night!"). Who's there with blarney for the dames? Just leave that stuff to him! (You guess; we never mention names.) Sure! Cogan, J. for Jim.

Why the Cable Shops Monopolize the Marriage Column

It's a long time since the C., R. & I. Shops had a look in on the News, except through the married column, but we'll bet no editor would have the heart to turn down *this*



contribution. All except one of these good-natured young ladies are still single. Miss Burgeson changed to Mrs. Paul Rosell lately, but you still have a chance for one of the others.

No use mentioning the dental concern who takes care of all those pretty teeth either, but we don't mind naming the girls. Top row (left to right): Misses Schwab, Bergman, Waller, Staden, Shaw, Henry, Cunningham. (In

rear): Misses Flynn, Hugelay, Schwartz, Schooler. First row (left to right): Misses Hochberger, McDonald, Mrs. Rosell, Misses Hanson, Anderson, Poulin.

It's Decided. You Can Sleep Nights Now

The second annual baseball game between Kasley's "Layouts" and Hosford's "Method Men" for the championship of the technical branch was held Saturday, July 7th. The "Layouts" were out for revenge to atone for the defeat received at the hands of Hosford's men last year, and they got it by scoring seven runs to the "Method Men's" three.

A sumptuous dinner preceded the game.

The box score follows:

Kasley's Planning Pirates					Hosford's Methodical Microbes						
	R.	H.	P.O.	A. E.		R.	H.	P.O.	A. E.		
La Vigne, ss...	0	2	2	1	1	Bellamy, 3b....	1	0	2	2	0
Schuster, 3b....	2	2	1	2	0	Craig, 1b.....	0	2	6	1	0
Vesely, c.....	2	2	10	2	0	Gould, 2b.....	0	0	2	2	0
Kerins, 1b....	1	1	7	0	0	Erwin, ss.....	1	0	0	3	1
Gantzer, rf....	1	1	0	0	0	St. Pere, cf....	0	1	3	0	0
Kremski, cf....	0	1	1	0	0	Shaw, lf.....	1	1	2	0	0
Glossenger, 2b..	0	1	2	2	0	Becker, rf.....	0	0	2	0	0
Smith, lf.....	0	2	2	0	0	Fellows, c.....	0	1	5	1	0
Langosch, p....	0	1	1	1	0	Stevenson, p....	0	0	2	1	0
Geraghty, p....	1	1	1	2	0	Accola, p.....	0	0	0	0	4
Totals	7	14	27	10	1	Totals	3	5	24	10	5
Pirates	2	0	1	0	3	1	0	0	0	—	7
Microbes	1	0	0	1	0	0	1	0	0	—	3

Two-base hits—Kremski, Smith, Geraghty, Craig. Three-base hits—Schuster, Vesely. Stolen bases—La Vigne, Glossenger. Hits—Off Accola, 13 in 4½ innings; off Langosch, 3 in 4½ innings. Hit by pitched ball—Vesely. Wild pitches—Accola, 6. Struck out—By Langosch, 7; Geraghty, 8; Stevenson, 3; Accola, 0. Passed ball—Fellows. Umpires—Rayspis and Sterling. Time—1:42.



Something to Arrest Your Attention, Ladies

Fearing that perhaps the News has not been catering sufficiently to the preferences of the ladies, the editors persuaded a detachment of Hawthorne's special police officers to pose for a picture, which we hasten to publish in

the hopes of squaring ourselves with the sex. Some of the beauty squad are married, but that is no reason why the girls shouldn't try to pick out the particular handsome

officer (or the particularly handsome officer) who views their working cards every morning—pick him out in the picture, of course, we mean.



ROLL OF HONOR

CURRENT AWARDS OF OUR SERVICE BADGES

To Be Awarded in August

TWENTY-FIVE YEARS			
Horner, W., Hawthorne	August	—	
Dunn, D. J., Hawthorne	August	—	
Rider, E. D., Hawthorne	August	8	
Reed, J. F., New York	August	1	
TWENTY YEARS			
Myers, W., Chicago	August	12	
McCann, W. J., Hawthorne	August	12	
Fuller, Mary, Hawthorne	August	16	
Devany, J. E., New York	August	23	
Schulz, J., New York	August	30	
Strucken, G., New York	August	30	
Strucken, C., New York	August	19	
FIFTEEN YEARS			
Montchyk, E., New York	August	—	
Erickson, E. J., Hawthorne	August	1	
Carroll, C. P., Hawthorne	August	4	
Liessner, H. O., Hawthorne	August	5	
O'Donnell, P., Hawthorne	August	12	
Olson, G. E., Hawthorne	August	12	
Lane, P. J., Hawthorne	August	15	
Ehret, W., Hawthorne	August	25	
Noonan, P., Hawthorne	August	31	
Doolittle, F. W., Minneapolis	August	1	
Barton, T., New York	August	7	
Borja, F., New York	August	14	
Meyers, Maggie, New York	August	25	
			Ulrick, W. B. August 5
			Emaus, B. August 11
TEN YEARS			
			Klug, G. N., Chicago .. August 1
			Geddes, P. J., Hawthorne .. August 1
			Herron, W. T., Hawthorne .. August 1
			Kirk, F. W., Hawthorne .. August 1
			McNamara, G. A., Hawthorne .. August 1
			McIntosh, D., Hawthorne .. August 1
			Neal, A. J., Hawthorne .. August 1
			Jicha, J., Hawthorne .. August 1
			Baldwin, W. H., Hawthorne .. August 5
			Fogel, J. P., Hawthorne .. August 5
			Ebenhoh, J., Hawthorne .. August 8
			Eck, C. P., Hawthorne .. August 8
			Pagrzyinski, S., Hawthorne .. August 17
			Bailey, B. D., Hawthorne .. August 19
			Gustafson, F., Hawthorne .. August 19
			Neumann, Mary, Hawthorne .. August 23
			Wolak, M., Hawthorne .. August 24
			Beers, J. K., Hawthorne .. August 27
			Delebeck, J., Hawthorne .. August 28
			Hinman, L. G., New York .. August 5
			Hall, N. A., New York .. August 1
			Larlee, H. A., New York .. August 1
			McIntyre, J. A., New York .. August 12
			Walcott, D., New York .. August 6
			Hunkele, A. J., Pittsburgh .. August 7
			Palmer, J. H., Pittsburgh .. August 26

Who They Are

E. D. Rider

A department head has considerable opportunity to get acquainted with a man in 23 years, so it seems a perfectly safe bet that a man who has stayed with the same foreman for that length of time must be a very easy man to live with. "Bud" Rider, who gets a 25-year service button this month, has spent 23

of the 25 years with S. C. Wiley, of the coil-winding department. With the exception of two years in the general offices at Clinton Street, when he first started with the Company, Mr. Rider has worked continuously in coil-winding departments, first on armature and field-coil work in the old power apparatus shops, and then in the telephone coil department, where he now is general repair man in charge of the machines.



E. D. Rider

D. J. Dunn



In the old days of the New York Shops' clam-bakes one of the events used to be a 100-yard dash, and one of the eventers used to be "Smiler" Dunn, now in the hand-screw machine department at Hawthorne. Mr. Dunn does not dash any more, but he still smiles. He has been on the hand-screw machine ever since he came with the Company in August, 1892, which entitles him to a three-star button this month—and another smile.

Mary Fuller



Some people would feel that Friday the 13th was no day to start on a new job, but Miss Mary Fuller is not superstitious. She began with the Company, Friday, August 13, 1897, the season most of us select to get away from the job for our vacations. Her preferences were for clerical work, but none was available at that time, so she started work on the winding lathes for Geo. Du Plain. She soon graduated to clerical work in the Magnet Wire Department and was general foreman's clerk during the last years at Clinton Street. Ever since the move to Hawthorne, nine years ago, Miss Fuller has been record clerk in the Inspection Department of the C. R. & I. Shops. For the past two years she has been a frequent sufferer from rheumatism, but now, following an operation for the removal of her tonsils, she is

beginning to feel like herself again, and expects to be back on the job in time to receive her two-star button this month.

W. J. McCann



When the Western Electric Company hired W. J. McCann in the armature-winding department it did a lot for its future athletic renown, for later "Bill" was captain of the Commercial League Baseball Team at Hawthorne when it won the championship for three straight years. In this capacity he went to Cuba with the team in 1907, when they made the trip as winners of the Chicago *Examiner's* baseball contest. Besides playing baseball Mr. McCann has annexed several medals at Hawthorne as a 100-yard dash man. Besides all this he has found time to gain considerable shop experience, having worked in the hand-screw machine department and the sub-set assembly department before taking up his present work in the output department. He has a 20-year service button coming to him this month.

W. Horner

When a man's name is Horner his friends generally seize the opportunity to nickname him "Jack," after our old acquaintance made famous by Mother Goose. However, the fellows in the hand-screw department have refused to do the obvious in the case of William Horner. So he remains simply "Bill." In spite of that, however, he has succeeded in pulling out a few plums for himself during the 25 years he has been with the Western, and he is now a gang boss in his department. He gets another this month in the form of another star for his service button.

Two and Three Star Badge Men



J. F. Reed



C. Sturoken

Their Badges Show One Star



P. O'Donnell



E. Montchyk



C. P. Carroll



F. M. Borja



E. J. Erickson



H. J. Lissner

Regarding Beneficiary Changes

Employees who have made out record of service cards and designated beneficiaries to whom they wish benefits paid in case of death should keep the Secretary of the Employees' Benefit Fund Committee advised of any changes in these beneficiaries made necessary by reason of marriage, death of those named, or for any other reason. Ordinarily the order of beneficiaries specified in Paragraph 3 of Section 8 of the Plan should be followed, and if not followed the employees naming other beneficiaries than these should furnish the Benefit Fund Committee with their reasons for so doing.

Results of New Customers and New Business Contest for May, 1917

THE salesman securing the largest number of new customers during May was:
G. B. Pfeifer.

The salesmen securing the highest number of points or sales to new customers for the period ending May 31st were:

- G. McCallum, Kansas City, 402 points.
- A. B. Spicer, St. Louis, 308 points.
- J. E. Lowrey, Dallas, 290 points.

Western Electric Men Under Oath for Military Service

National Guard

HAWTHORNE

Adams, J. L. Alderson, M. Alloway, F. L. Altschuler, J. O. Anderson, L. F. Anderson, O. Aquilino, A. Ayers, C. V. Baker, H. S. Ballentine, R. A. Barron, W. H., Jr. Barron, O. H. Bates, J. F. Beck, W. R. Bell, J. H. Bentley, E. N. Berglund, E. N. Bernacki, A. Berry, A. E. Bierma, A. W. Bills, E. J. Bloomfield, W. N. Borowiecki, W. Bowles, B. Bradford, E. C. Brooks, M. O. Brown, H. F. Brownstein, L. Bruno, A. R. J. Buchanan, W. H. Buchi, H. H. Budzik, G. M. Bunnell, A. E. Burlew, C. N. Burmister, L. H. Burns, R. Caldwell, W. E. Callahan, F. J. Carlson, A. W. Carothers, H. S. Carroll, F. W. Churchill, F. A. Clark, G. T. Clarke, C. M. Cline, R. E. Coston, F. W. Coyle, J. H. Coyne, M. B. Cross, J. A. Cummings, J. Czrenahowski, F. P. Darker, G. E. Davidson, W. W. Dempsey, T. F. De Witt, F. E. De Witt, R. Diets, W. F. Dippel, L. C., Jr. Doyle, H. F. Drucker, S. J. Du Mont, J. F. Dyon, J. T. Eddy, J. M., Jr. Edmiston, L. P. Ekberg, R. A. E. Errgang, W. A. Evans, J. H. Fabisah, S. J. Feyereisen, P. J. Flaks, W. Fowler, R. R. Friedwald, H., Jr. Galavan, J. Gauverson, S. Geeting, J. G. Glenn, R. J. A. W. Goodwin, A. W. Gourley, G. B. Greben, A. Grogan, J. Gurke, A. Gurka, W. G. Hamper, R. J. Hansen, R. Hartig, F. J. Harvey, G. M. Hasenjaeger, G. Hatfield, R. F. Haycraft, P. E. Helmerding, O. F. Henderer, A. M. Henry, H. E. Herry, I. A. Higbee, F. G. Hodapp, J. Hoff, G. J. Hoffmann, W. A. Horrigan, W. T. Houlihan, J. J. Hruska, L. M. Hubbard, W. E. Hudson, T. R. Hughes, A. F. Hull, F. D. Hundt, T. A. Jandeseck, G. Janz, G. A. Johnson, F. Johnson, H. E., 6615 Johnson, H. E., 6965 Jordan, F. W. Julian, W. F. Kakuska, T. D. Kamina, G. G. Kapra, R. L. Kares, W. Kendall, R. C. Ketcham, H. J. Kiefer, C. E. King, H. D. Kirkland, W. B. Klomp, A. A. Klett, T. Kneitz, H. R. Kobilak, A. F. Kostanick, A. Kozick, J. L., Jr. Krell, R. R. Kretschmar, O. R. Kressler, A. Kriever, A. E. Kude, G. Kuebler, F. Lamb, E. Laurence, W. La Vallie, O. E. Lentsch, E. J. Lind, T. E. Lyons, J. D. Madigan, E. F. Mangan, G. W. Manuel, T. B. Matuga, S. Marvan, J. McCarthy, J. J. McDermed, J. F. McDonald, J. C. McMahon, A. E. McNeil, F. J. Melling, W. Mellinger, G. Meneley, J. L. Meyer, W. Michalson, J. J. Mielke, F. A. Miller, H. W. Miller, I. Miller, R. H. Mitchell, F. M. Mitchell, J. S. Mix, G. H. Moore, F. Mortrud, A. G. Meehan, C. W. Murray, P. E. Nybeck, W. R. Narkiewicz, A. Nelson, L. J. Ness, J. T. Ness, J. Newton, G. D. Norton, T. J. Nowak, L. E. Nutt, R. F. O'Brien, J. E. O'Hagen, P. O'Neill, C. Obrack, J. Ostrander, J. L. Otto, H. M. Overstreet, A. P. Fallon, G. C. Parkins, F. E. Phillips, L. G., Jr. Piekarski, J. J. Pierce, H. G. Piggott, T. A. Pinkham, H. H. Piotrowski, S. Pietka, C. Polson, H. S. Pollak, S. P. L. Potter, H. N. Powell, J. E. Prue, L. R. Ripkey, J. L. Rojahn, H. Rose, W. A. Rossiter, A. E. Royer, R. E. Rude, W. L. Sachs, E. C. G. Schaublin, H. Schenck, R. O. Schildknecht, F. A. Schlechta, J. A. Schlichting, O. H. Schlottag, A. Schueman, M. O. Schultz, J. A. Scranton, W. O. Sears, J. E. Seibert, H. Sherman, W. P. Simon, R. B. Simonton, P. D. Skrah, E. Skrah, L. Slater, R. O. Snyder, C. A. Solhem, A. Solomon, D. E. Spitzler, P. Spoerl, W. P., Jr. Stack, B. Stafford, S. E. Storm, B. L. Sturgeon, W. H. Sullivan, B. M. Szalacinski, W. J. Tache, H. J. Tetzlaff, O. A. Tobias, G. D., Jr. Tragin, M. Trantin, J., Jr. Trienen, H. W. Trogman, H. Turvill, E. F. Uhler, A. G., Jr. Urbanaki, S. Valentine, L. Vana, J. E. Vanek, O. Vandercook, F. I. Vanderwerker, W. E. Veale, F. J. Veale, E. W. Vickery, E. W. Vidal, A. A. Vorrever, F. W. Vrasill, L. J. Waldron, A. M. Warren, S. E. Waterhouse, J. R. Way, M. E. Weber, O. A. Weber, P. Werner, F. White, J. R. Wilson, E. Wright, N. Wrona, L. P. Young, J. V. Zalkus, J. J.

GENERAL SALES DEPARTMENT—195 BROADWAY

Branstater, H. F.

GENERAL ACCOUNTING DEPARTMENT—195 BROADWAY

Lafferty, J. P.

NEW YORK ENGINEERING DEPARTMENT

Allen, A. Allen, J. E. Boise, E. W. Booth, W. E. Bown, A. S. Crawford, W. G. Egan, J. B. Fogel, M. Forsyth, A. K. Graves, C. C. Hague, A. E. Hall, A. M. Haug, J. H. Hooker, R. F. Ketcham, R. C. Landgraf, G. F. Lawrence, A. W. Millard, F. S. Motley, J. G. Morris, J. H. Murray, J. E. Oberlin, A. F. Pease, A. F. Phillips, E. M. Sample, F. M. Samuels, O. G. Shaifer, O. H., Jr. Stonebridge, W. E. Tuna, L. Ueland, L. M. Unbekant, F. E. Velt, J. G. Walcott, D.

BOSTON

Cairnie, H. Collins, H. L. Collum, D. W. Conway, L. J. Eaves, R. D. Fandel, T. J. Frost, H. G. Hardy, W. R. Haynes, W. G. Johnson, J. J., Jr. Manthorne, H. N. Nielsen, C. H. Noyes, C. K. Patterson, R. E. Perkins, A. H. Ryan, R.

NEW YORK

Allen, J. L. Ashley, F. J. Barry, D. R. Bieber, J. G. Brarston, J. P. Clark, D. G. Dittman, E. H. Fisher, B. C. Garbarino, J., Jr. Habermann, R. Hines, W. J. Holligan, F. Joseph, J. Kloth, H. W. Knudsen, H. W. Koch, W. D. Lynch, J. V. Manuchia, M. J. Marsh, O. Masza, N. F. McMahon, J. D. O'Brien, F. W. Olsen, F. Palmer, F. O. Reese, W. L. Rose, D. Rousie, J. H. Schadler, H. J.

DISTRIBUTING HOUSES

Schneider, L. J. Seaman, B. W. Seltenrich, F. Smith, F. Smith, L. L. Snyder, G. G. Snyder, J. L. Sullivan, J. W. L.

PHILADELPHIA

Baker, E. G. Jackson, S. H., Jr. Randolph, M. F. Scull, M. L. Smyth, E. Stevens, C. F. Stoner, R. A. Sweeney, T. E., Jr. Thompason, G. C.

PITTSBURGH

Peters, E.

ATLANTA

Moseley, R. B. Burton, R. M. Salau, A. A. Thaxton, B. A.

CHICAGO

Du Mont, W. E. Genicks, R. J. Manix, D. D. Richlewski, E. J. Saxton, R. M. Scheidler, E. G. Smiley, A. D. Smith, R. A. Tilley, R. Wolf, F. M.

CHICAGO (Cleveland)

Schleicher, B. Whitcomb, C. B.

CLEVELAND

Kimball, F.

CINCINNATI

Grasle, H. D. Hamilton, C. H.

OMAHA

Hoesley, R. H. Johnson, T. Snyder, L. G.

ST. LOUIS

Huber, A. B.

KANSAS CITY

De Forest, R. F. Saylor, W. E. Stone, H. B. Thornton, T. M.

DALLAS

Clayton, A. B. Lawson, C. K.

DENVER

Stephens, E. P. Thompson, A.

SAN FRANCISCO (Emeryville)

Herbert, V. F. Irvine, T. S. Vervais, W. J.

SEATTLE

Friedenthal, O. G. Herrick, R. D. Talbot, G. S.

LOS ANGELES

Black, W. E.

Reserve Signal Corps

NEW YORK ENGINEERING DEPARTMENT

Fox, A. W.

DISTRIBUTING HOUSES

ATLANTA

Hix, H. H. Lowery, W. W. Miller, J. G. Whitmire, O. Stepp, J. O. Weaver, C. V.

Naval Reserve

HAWTHORNE

Becker, E. B. Bugner, C. E. Consier, E. J. Deering, W. L. Drysch, R. J. Gibbons, W. J. Henderson, H. F. Hernalund, J. W. Kenney, G. P. Kline, H. N. G. Knoff, S. V. Lambe, H. W. Lucker, W. A. Maguire, W. J. McGarry, J. J. Mitch, J. J. Nottke, W. A. Rice, A. C. Sale, S. W. Shannon, J. E. Staake, W. F. Unger, M. S. Voelker, W. R. Weiss, W. L. Woellel, H. L.

GENERAL SALES DEPARTMENT

Otto, G.

GENERAL ACCOUNTING DEPARTMENT

Reddall, H. H. Burrell, A. R.

NEW YORK ENGINEERING DEPARTMENT

Fink, H. C. Haeselbarth, P. T. Larkin, W. A. Randall, H. E. Sorenson, H. Wangarin, P. P. F.

DISTRIBUTING HOUSES

NEW YORK

Hagen, A. R. Osborn, D. Reeves, C. E. Bogart, L. H. Brooks, W. H. Frazer, W. Gallagher, A. J.

ATLANTA

Higgins, L. Laurent, J. A.

PHILADELPHIA

Lynch, J. J. Nessler, T. D.

OMAHA

Lammey, F. V.

National Guard Reserve

HAWTHORNE

Anderson, A. G. Brotje, G. J. Buck, C. D. Finley, C. J. Glennen, J. F. Hackett, F. R. Hasdra, J. J. Henderson, D. R. Iverson, E. Kennedy, J. D. Komorowski, M. M. Krieka, H. E. Lingo, C. A. Markson, H. C. McBride, J. O.

NATIONAL GUARD RESERVE—Continued

McDaniel, R. L.	O'Brien, F. E.	Stirek, F. M.
Miller, C. E.	Reynolds, L.	Valence, H. L.
Moreland, H. B.	Richardson, L. S.	Veagne, E.
Newcander, H. D.	Stanley, F. L.	Will, W.

GENERAL SALES DEPARTMENT

Hazley, G.

NEW YORK ENGINEERING DEPARTMENT

Boirayon, C. A.	Joho, E. C.	Oberlin, A. F.
Brill, W. E.	McGuigan, R. A.	Sailer, P. M.
	Wadley, J. R.	

DISTRIBUTING HOUSES

NEW YORK	Santora, A.	CHICAGO
	Spence, E.	Bilster, B.
BROCKING, E. T.		Pritchard, G. S.
Carter, F. E.	BUFFALO	
Copeland, W. J.	Miller, F. A.	SAN FRANCISCO
Derrick, G. C.		Bradford, H. D.
Dunkell, G. J.	NEW HAVEN	
Grau, C. C.	Bub, J. A.	
McGlincey, H. A.		

Reserve Officers' Training Camp

HAWTHORNE

Barden, A.	Fox, H. W.	Townsend, F. P.
Crowley, S. L.	Jarrett, E. L.	Wiese, L. K.
DeGraw, A. E.	Olson, P. H.	Williamson, T. L.
Ellison, L. H.	Poole, R. J.	

GENERAL SALES DEPARTMENT

Folks, I.

NEW YORK ENGINEERING DEPARTMENT

McCartney, A.	O'Donnell, R. C.	Parisette, J. O.
---------------	------------------	------------------

DISTRIBUTING HOUSES

BOSTON	NEW YORK	NEW YORK
Baker, D. B.	(New Haven)	Kaufman, B.
	Gaylord, B. J.	Mason, J. G.
		Whitehead, E.
NEW YORK	PHILADELPHIA	RICHMOND
Davis, H. A.	Craven, T. S.	Dashnell, R. M.
Stickler, W. W.	Vaughan, M. L.	
	CHICAGO	
NEW YORK (Buffalo)	ATLANTA	Julien, D. M.
Neville, W. H.	Full, H. P.	Walker, E. T.
		Weik, J. E.

Enlisted Reserve

HAWTHORNE

Miller, W. C.

U. S. Marine Corps

HAWTHORNE

Witthaus, G.

ST. LOUIS

Hutchinson, C. C.

Reserve Engineers

NEW YORK ENGINEERING DEPARTMENT

Barnes, C. Y.	Harris, H. W.	Schreiber, A.
---------------	---------------	---------------

DISTRIBUTING HOUSES

PITTSBURGH
Peters, G. A.

U. S. Navy

LEGAL DEPARTMENT

Helland, E. A., Jr.

NEW YORK ENGINEERING DEPARTMENT

Coomba, G. M.

DISTRIBUTING HOUSES

CHICAGO
Butler, J. M.

KANSAS CITY

Paxton, G. A.

Osborne, A. J.

U. S. Army

HAWTHORNE

Wopenske, A. L.

NEW YORK ENGINEERING DEPARTMENT

Couture, A.

Lawless, T. P.

Titus, R. J.

DISTRIBUTING HOUSES

NEW YORK
McCormack, J. P.

CLEVELAND
Brunswick, A.

Aviation Section—Signal Corps

NEW YORK ENGINEERING DEPARTMENT

Hill, R. S.

DISTRIBUTING HOUSES

RICHMOND

Quarles, H. deW.

Red Cross Base Unit

NEW YORK ENGINEERING DEPARTMENT

Evans, Madeline

Rignel, Jane I.

DISTRIBUTING HOUSES

NEW YORK

Hessler, W. F.

Hopwood, I. B.

Wilke, F. H.

CHICAGO

Bell, A. F.

ST. LOUIS

Delany, G. L.

Quartermasters' Reserve Corps

DISTRIBUTING HOUSES

CHICAGO
Greene, P. W.

OMAHA

Carnaby, J. R.

Naval Volunteers

HAWTHORNE

Anderson, T. B.
Brems, O. H.
Edgren, H. C.

Haderly, F. H.
Kosatka, F. V.
Krause, H. J.

Lancaster, R. J.
Sekol, T. S.

DISTRIBUTING HOUSES

NEW YORK
Patri, F. J.
Riese, F. M.

CHICAGO
Guest, D. C.

U. S. Navy Reserve

HAWTHORNE

Appel, J. M.

Childs, H. D.

Signal Officers' Reserve Corps

GENERAL SALES DEPARTMENT—195 BROADWAY

Kick, J. A.

NEW YORK ENGINEERING DEPARTMENT

Arnold, H. D.
Buckley, O. E.
Craft, E. B.

Curtis, A. M.
Dobson, G.
Howk, O. L.

Jewett, F. B.
Jones, K. L.
Slaughter, N. H.

DISTRIBUTING HOUSES

NEW YORK
Welles, Paul

SAN FRANCISCO
Calloway, A. J.

U. S. Army Reserve

HAWTHORNE

Anderson, E. S.
Ashwill, R. M.
Baris, W.
Beiderson, B. J.
Benedix, W.
Bernas, L.
Clifford, W. P.

Dentamaro, F.
Dooley, E. W.
Edmunds, J. E.
Gracek, J.
Janous, A. V.
Mackos, W.
Nitz, A.

Randle, R. E. B.
Sirois, O.
Vesle, H. A.
Wagner, C. P.
Waywood, P.
Witt, A.
Palach, A.

Naval Militia

HAWTHORNE

Arnold, E.
Barr, W. S.
Boehme, W. R.
Dey, H.
Forrest, W. S.
Gallagher, C. V.

Hall, A. G.
Herr, N. F.
Leach, C. E.
Lucker, H. E.
McElrath, L. F.
Schulte, H. G.

Smith, L. M.
Southwick, W. A.
Stample, J.
Vliet, W.
Watson, J. D.

GENERAL SALES DEPARTMENT—195 BROADWAY
O'Neil, C. J.

LEGAL DEPARTMENT
Webster, A. G.

NEW YORK ENGINEERING DEPARTMENT

Carlson, M. A. Lake, H. R. Sussdorf, B. R.

DISTRIBUTING HOUSES

NEW YORK
Buch, P. O.

SAN FRANCISCO
(Emeryville)
Muller, L.

Army Y. M. C. A.

NEW YORK ENGINEERING
Bockoven, L.

Ambulance Corps

GENERAL SALES—195 BROADWAY
Wildung, G. H.

NEW YORK ENGINEERING
Sasse, J. F.

Naval Coast Defense Reserve

NEW YORK ENGINEERING DEPARTMENT
Hartigan, E. T., Jr.

DISTRIBUTING HOUSES

RICHMOND
Tompkins, G. R.

Kunovaki, J. J.



The Radio Companies

Names of Applicants



Capt. M. K. McGrath, S. O.
R. C. (Special Studies)

**The Officers
of the
Eastern Radio
Company**

Vroom, E.
Lott, M. R.
Atwood, R.
Ash, J. E.
Cerveney, A. L.
Christen, A. B.
Crawford, W. G.
Dring, A. W.
Graves, C. C.
Johnson, H. B.
Lack, F. R.

Inglis, A. H.
Jeanne, P. A.
Price, C. S.
Southwick, L. F.
MacDonald, W. A.
Bair, R. S.
Landy, W. A.
O'Connor, M. R.
Hunter, J. F.
De Stefano, A.
Brown, T.

Singer, E.
Cruger, J. C.
Gates, W. J.
Grice, G. F.
Van Tubergen, G. W.
Reenstra, A. J.
Croll, C.
Kerr, D.
Kennelly, M. J.
Lynch, J. J.

Hawthorne

Officers

P. P. Brinkman, Captain
J. A. Greig, Lieutenant
H. S. Pratt, Lieutenant

Enlisted Members of Corps

J. A. Aldridge
R. B. Aiken
W. D. Adams
C. O. Beckley
F. Barth
W. Bouchard
W. C. Brand
F. T. Bolton
S. C. Clusack
C. H. Ohlad
H. Cothran
C. L. Daggett
G. T. Dougherty
J. F. Devine
E. Ellis
W. J. Erickson
G. A. Esping
J. E. Fisk
A. W. Gieseler
G. W. Gerber
F. J. Hoffman
R. J. Harkins
L. Hintz
W. J. Hartmann
R. E. Jelinek

N. L. Jannenga
J. F. Jurgens
H. S. Jackson
J. F. Jewell
H. G. Jordan
P. M. Komm
F. C. Kripner
C. S. Kistler
M. L. Logan
H. D. Lennon
A. L. Levy
F. Lopata
W. E. Mougey
A. Mosher
G. Masek
J. F. Masa
W. J. McArdle
C. N. Malmrose
G. A. Morency
A. F. Mueller
C. H. Munson
H. H. Meinhard
H. H. Norman
J. W. Wosek
C. J. Psutka

L. A. Peters
J. Petzelka
F. Rattenburry
H. Richards
R. A. Reynolds
W. J. Ribal
H. B. Roake
H. J. Ryan
A. J. Starner
E. M. Sczeck
H. N. Sampson
K. J. Story
W. C. Schultz
J. L. Siegenthaler
J. G. Sperling
F. R. Smith
J. J. Sullivan
G. F. Sindelar
J. Trojan
A. J. Tichy
G. R. Van Nest
W. W. Weller
O. Warner
G. J. Williams
S. V. Zackory



Lieut. G. C. Pratt, S. O. R. C.
(Secretary)



Lieut. L. A. Hagar, S. O. R. C.
(Transmission Branch)

Names of Applicants

Barclay, A. J.
Wild, J. R.
Bollinger, W. A.
Gahan, J. J.
Morris, A. E.
Olson, W. A.
Timmerman, S. G.
Fox, A. W.
Keller, J. C., Jr.
Miller, C. W.
Helwig, E. C.
Pflanz, J. H.
Von Zastrow, C. G.

Price, A. F.
Ranges, J. E.
Waite, W. H.
Wilson, C. E.
Peters, K. F.
Yeomans, L. D.
Carpenter, W. C.
Newell, C. W.
O'Neill, J. F.
Dorothy, L. E.
Peck, G. D., Jr.
Bland, H.
Bergstrom, A. M.

Stephenson, J. J.
Adams, J. J.
Goebel, A. C.
Gray, J. J.
Kellam, W. W.
Palmiter, L. B.
Weils, C. A.
Haggerty, D. D.
Moreau, W.
Kloth, H. W.
Taylor, W. E.
Berran, F. J.
Best, G. M.

Western Electric News

PUBLISHED MONTHLY FOR THE EMPLOYEES

BY THE WESTERN ELECTRIC COMPANY, INCORPORATED

H. B. Thayer, <i>President</i>	H. A. Halligan, <i>Vice-President</i>
W. P. Sidley, <i>Vice-President and General Counsel</i>	A. L. Salt, <i>Vice-President and Gen. Purchasing Agt.</i>
Gerard Swope, <i>Vice-President and General Sales Manager</i>	H. F. Albright, <i>Vice-President and Gen'l Superintendent</i>
J. W. Johnston, <i>Treasurer</i>	F. B. Jewett, <i>Chief Engineer</i>
G. C. Pratt, <i>Secretary</i>	E. H. Gregory, <i>Comptroller</i>
C. E. Scribner, <i>Consulting Engineer</i>	

Office of publication and address of President, Secretary, and Treasurer, 195 Broadway, New York City.

BOARD OF EDITORS

P. L. Thomson, <i>Editor-in-Chief</i>		
P. K. Condict	E. C. Estep	S. W. Murkland
W. F. Hendry	F. J. Holdsworth	H. D. Agnew
John Colter	Reed Calvin	

Subscription: \$1.50 per year, except to employees of the Western Electric Company, to whom copies are furnished free of charge.

All communications and contributions should be addressed to WESTERN ELECTRIC NEWS, 195 BROADWAY, NEW YORK.

Matter intended for any given issue must reach New York not later than the 12th of the preceding month.

VOLUME VI AUGUST, 1917 NUMBER 6

THE NEWS reproduces here a letter written by a Western Electric man upon the occasion of his enlistment. It was addressed to his immediate superior:

For several months I have felt that, as an Englishman, I was not doing my duty, as to the world struggle, and since America's entry into the conflict this feeling has been very much accentuated, and so many of my American friends have enlisted to go to France that I should feel a despicable slacker to continue in my present safe position, instead of doing my bit in the "thick-of-it." It is not a matter of bravery and I do not think that there is glory in war. It's just a duty, and so, to do that duty, I have enlisted in the "Signal Corps" as aero mechanician. Got through exams splendidly and rated for first-class sergeant.

Until called, I shall be very pleased to assist with the work in hand and to help any one you may designate to get used to the engraving machine.

Hoping the Company will be able to appreciate my feelings in this matter, I am,

Yours very truly,

ROBERT S. HILL.

This is an interesting letter. It reveals in its writer some of the best stuff that patriotism is made of. No one doubts, after reading it, that Mr. Hill's desire to "do his bit" is deep and sincere, that he stands ready to make a real sacrifice for the cause of the United States and the Allies. For he has given up a "safe job" for one of great possible danger. So much for Mr. Hill's case.

But would it be patriotic for *any* man in the Company to give up his "safe job" for a more dangerous one? Does the mere assuming of risk give a man the right to be called patriotic?

Not in these days of co-operation!

That man is most patriotic who mixes cold judgment with his quick impulses and fights where he will be of the most use, be it at the milling machine, the lathe, in the trench, or on the gun deck. Patriotism must be judged not by your motives alone, but by the amount of service you render to the cause.

"It is just a duty," says Mr. Hill, as he goes to work in the Aero Corps, and he is right. With equal force applies the slogan to the man at the machine at Hawthorne—or wherever he is, so long as he is indispensable to the Company in its service to the Government—"It is just a duty."

Remember that England, early in the war, found it necessary to bring back men from the "thick-of-it" and give them "safe jobs" in the factories at home, in order that armies in the field should be properly supported.

THE SELECTIVE DRAFT

THE ways and methods of the conduct of the selective draft have become known to most Western Electric men either through the newspapers or notices posted on the Company's bulletin boards. The time allowances for the filing of exemption claims and the details of reasons for exemption, if, however, not yet clear to some, can be found in Provost Marshal General E. H. Crowder's *Information for Registered Persons*—copies of which have been generally distributed within the Company to employees of draft age.

By the time the NEWS comes from the press, many Western Electric men will probably have been summoned by their local boards for physical examination, and hundreds of others will automatically approach nearer to the possibility of draft. The Company's policy in regard to industrial exemption is summed up in the final words of Mr. Thayer's message on page 1:

"We have made representations to the United States military authorities, and shall continue to make them, in the effort to retain in our service those whom we believe can do better national service in the work for us, for which they are specially qualified, than in military service, for which they have no special qualifications."

THAT PHOTOGRAPHIC CONTEST

DO not allow the seductive waves of the seashore or the equally alluring humps of the mountains to soften your determination to enter the NEWS' Vacation Photo Contest. A shutter never clicks so satisfactorily as in the month of August.

GROWTH

ON July 1st the employees of the Company numbered 30,434. This is the first time in the history of the Western Electric Company that the number has passed the 30,000 mark.

AROUND THE CIRCUIT

GOSSIP GATHERED BY THE DISTRIBUTING HOUSE CORRESPONDENTS

Seattle

Jo Sorenson, Correspondent

Moving the immense stock of the Western Electric and associate companies in the time of twenty-four hours with no interruption of service in delivery of material to customers is the record established by the Seattle organization. It came about this way: At 5:15 on Friday the office



Seattle's New Location

force left the old location and at 8:30 A. M. Saturday were at their new desks and ready to resume work. Owing to the proximity of the old and new office buildings it was possible to transfer all records, advertising matter and office equipment in a very short time. Matters were expedited a great deal in handling by the organization of a moving crew from the members of the Stores and Sales Departments.

In moving the stock from the old warehouse a much different problem presented itself. Separated by a distance of one and one-half miles, it became extremely necessary to cut down the handling of material to a minimum. This was accomplished by loading onto the tracks stock from a certain numbered section of bins. This load was then carried and unloaded directly into a corresponding numbered section already constructed in the new warehouse.

Unusual difficulty was experienced in lifting the hundreds of tons of stock that were to be placed on the second floor and in the basement. The large elevator motor and equipment ordered from the East became lost in transit, necessitating the installation of a temporary hand lift.

Our new location is excellent. Marion Street, one of the best known short cross streets, is usually filled with passing crowds. Colman Dock, Seattle's largest dock for local passenger vessels, lies but a block away at the foot of

this street. Western Avenue, on which we have a 200-foot frontage, is one of the four great thoroughfares of the city.

For many years we were located at 1518 First Avenue South, in the heart of what was then the wholesale district, but the city grew rapidly and spread northward until it became necessary for us to open an uptown office. This we did and for five years maintained offices and retail store at 907 First Avenue, warehousing our stock, however, at the old location. But again we were forced to move and now have offices and warehouse under one roof. While it was necessary to discontinue the retail store at that location, a retail counter has been installed on the office floor and immediately adjacent the stairs from the main entrance. "907 First," a name synonymous with electrical merchandising, has been changed to "84 Marion."

The building is a two-story brick with a deep, full basement. The offices are located on the second floor facing Marion Street and occupy the whole of one end of the building.

In the warehouse conditions are excellent. On the second floor there is available 20,000 square feet of floor space, on the first floor over 2,000 square feet and in the basement 10,000 square feet.

New York

D. Broadhurst, Correspondent

During June and July F. H. Leggett gave two series of four lectures each before the Tuck School of Administration and Finance at Dartmouth College on the subject of merchandizing, layouts and methods as used by our Company. The lectures formed part of a course in Army Store-Keeping to prepare the students for positions as Quartermaster Sergeants in the Ordnance Department of the Army, the course being given at the request of the Council of National Defense.

While most of us were securing our "Bonds for Liberty" some were giving up their "Liberty for Bonds." Really, did you ever buy so many wedding presents?

Really nothing counts these days, but orders placed by or for the Government marked "emergency," and of these the telephone companies are placing many. To handle orders from Washington a new service department has been formed. The former force has been doubled and can be still further enlarged should demands upon it increase.

Familiar faces disappear, and when we ask where these friends have gone the answer comes back, "He has joined the Army," or, "He is on guard duty." There are so far thirteen of our men now in service and fifty signed and awaiting orders.

Rumors fill the air. The other day we learned that our buyer, H. W. Jackson, is drilling with the home guard "for exercise." Also W. E. Rice, credit manager, was back from a trip long enough to take care of the South Orange Reservoir for a night—perhaps it might be better to call it the "Water Works" so that there may be no doubt about what he was guarding.

Another New Haven Employee Is Drilling

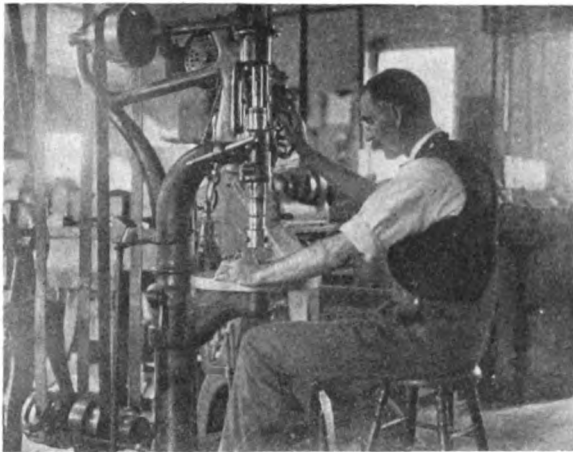

Our young ladies, under the leadership of Miss Curry, are forming a knitting club to help make trench life more comfortable, particularly for Western Electric men. This might help recruiting, although there is sure to be a doubting Thomas somewhere who would want to see a sample pair of the socks that "Our girls" were turning out.

Voice on the wire: "I am to spend the summer in a town where the electricity is made by water power. Will my Western Electric No. 1 iron work as well on that kind of electricity as the kind made by steam, here in New York?"

(This inquiry was turned over to the engineering department. After several days' research they assured us that the moisture created in electricity by water was no greater than by steam. This certified report was immediately sent our customer.)

Different parts of the country see different ways of doing their bit. While the farms of the Middle West are producing magnificently, which is their bit, would that our fellow employees of the interior might see what we of New York are seeing these days in the greatest seaport of the Western Hemisphere—the latest type of submarine, submarine chasers, torpedo destroyers, new type of cargo ships, converted German and Austrian steamers, cruisers, flotillas and barges, loading grey vessels, at their docks to-day and gone to-morrow.

These sights are naturally more inspiring than the long expanse of waving fields of grain. And how we wish for some wonderful electrical inventions, which might make it possible for our friends of the great western country to see them.

Mr. Robert Gordon, of the Gordon clan (note the Tartan), happened to be in Newark last week while the recruiting Highlanders, clad in kilties, were rounding up

Scotties for the armies somewhere in France. After waiting several hours for Mr. Gordon, Mr. Hurd, Newark Manager, and of the same family as the famous Scotch golf player, started looking for him. "Bob" was found standing on the leader directing the band and in the thick of the NOISE! Later he went home.

J. J. Feiner was seen at the ranges at Sea Girt recently; qualifying as sharpshooter for his home guard company, said to be the crack company of Newark. He stated that his experience as Western Electric salesman, shooting at bogies, helped him greatly in his marksmanship.

Omaha

M. A. Buehler, Correspondent



Three Bartenders—H. W. Goodell, A. H. Bannister and M. A. Buehler—at Western Electric Picnic

for our married men who get away only once a year—that time being at such an occasion as this.



We had with us at our picnic a distinguished gentleman from our New York General Department. To show his popularity we exhibit two pictures which are the envy of all our Omaha young men. If Mr. Mark Curran ever comes to Omaha again we suggest he bring a Pinkerton man with him for personal protection. The food, races, games, etc., at the picnic were exceptionally good. Except the dyspeptics and rheumatics, every one fell in love with them.

Chicago

W. M. Goodrich, Correspondent

VAIN DESIRE

Has any man his heart's desire?
 Or, having it, is he content?
 The magnate wants a million more—
 The kid of five wants just one cent;
 The boy can scarce wait to grow up,
 And grown-ups sigh for vanished youth;
 Some other fellow's cute Janet
 Looks better to us than our Ruth.

Those on the throne long for a hut;
 Those in the hut yearn for the throne;
 It's ever that another job
 Looks better to us than our own.
 Where is the man who's satisfied
 To take each hour as it is spun?
 In summer-time we long for snow—
 When winter's here we want the sun.

And so we thought if we could be
 Your correspondent, reverent,
 Our cup of joy would be complete—
 But now it's here, we're not content!

—W. M. G.



W. M. Goodrich, News Correspondent



Geo. I. Nielson Has Joined the Navy

THE SUNSHINE TOWN OF BERRIEN COUNTY

C. Curtis will tell you that Buchanan is the "sunshine town" of Berrien County, Mich.—and he is right. When he exhibited one of our light plants there they stood around in droves. Witness the picture.

The Buchanan News gives Mr. Curtis, the Company and the News the following send-off:

"The business of Buchanan has increased by leaps and bounds the past two or three weeks, and attracted by the Saturday gather-



The Demonstration of Our Sunshine Plant at Buchanan

ings and the interest displayed by Buchananeers in standing by their home town, the Western Electric Company of Chicago thought it was so interesting that they are going to tell their readers about Buchanan in a famous journal.*

"On last Saturday C. Curtis, representing the Western Electric Company of Chicago, came here with a photographer and took street scenes, which will be reproduced in THE WESTERN ELECTRIC NEWS, together with a story outlining the various features of interest the local business men provide for the entertainment of town and countryside. Mr. Curtis, who demonstrated a farm lighting plant, manufactured by the Western Electric Company here a couple of weeks ago, was so strongly impressed with the enterprise and fine spirit displayed in Old Buchanan that he returned Saturday to get a picture of the week-end gathering with which to illustrate a story, in which he will tell the 200,000 subscribers of THE WESTERN ELECTRIC NEWS how the get-together spirit works in Buchanan, the 'Sunshine Town' of Berrien County."

*This is us.—Ed.



Charles E. Wenzel, of the Clinton Street shop, recently gave his wife an American Beauty flatiron, a proceeding which, while praiseworthy, is not entirely unusual. The above, however, is significant because Mr. Wenzel won the iron by making a suggestion which will save the Company hundreds of dollars. Mr. W. H. Boesenberg, our Shop Superintendent, recently offered a prize for the employee who would make the most valuable suggestion for improvement in shop methods or apparatus. A large number of very useful suggestions were made, but the one by Mr. Wenzel, for improving the method of removing paint from cable boxes and metal subsets, won the prize. Mr. Wenzel began with the Western Electric Company at the New York shops in 1904, and has been employed both at Hawthorne and Clinton Street since that time. Another contest will soon be started, as this one was such a decided success.

Chicago's Quartermaster Captain



CAPTAIN P. W. GREENE, U. S. R., began his Western Electric career in the Engineering Department at Hawthorne July 1, 1912. He spent a year at Hawthorne, coming to the Sales Department at Clinton Street where for two years he was in charge of Retail Sales. He then entered the Credit Department from which he was called to the colors.

Captain Greene is in the Quartermasters' Department and holds the highest rank of any Clinton Street man in the Army. He is attached to the Southeastern Department in charge of a motor truck company and is now stationed at Columbia, S. C.

On June 18th the Passport Club, a Clinton Street Girls' Club, gave a dancing party at the Humboldt Park Pavilion, which was largely attended and a decided success. The proceeds were donated to the American Red Cross.

R. G.

Cleveland

Jim Metcalf, Correspondent

The office it don't seem the same
 Since "Philip" went away;
 The girls they go about their work
 With nothing much to say;
 The gang down in the shipping-room
 Is quiet as a mouse
 Since "Philip's" been promoted and—
 Has left the Cleveland house.

Tom Wheatley chews his daily quid
 With such a thoughtful brow.
 The other chaps all kid him out—
 He buys his chewing now.
 For "Philip's" off to Cincinnati,
 The town that kept us wet—
 No wonder that we one and all
 Should show sincere regret.

The waiter over at the "club"
 Where "Philip" used to eat
 Still orders up the cornmeal mush,
 But mourns the vacant seat.
 The driver of the big ton truck,
 The one that "Philip" "rode,"
 Just ambles in—and looks around,
 And then takes out his load.

But "Philip," here's to your success,
 We miss you, sure 'tis plain,
 Tho' we are glad that Cleveland's loss
 Is Cincinnati's gain.
 And, "Philip," when you can't just see
 A lining in the cloud,
 We hope you'll not forget to bank
 On your old Cleveland crowd.

—Jimmy Metcalf.

Dallas

S. Zercher, Correspondent

Mr. Miller returned from Chicago with a stiff neck,
 presumably from looking at the high buildings. It was
 also rumored that he bought the Masonic Temple and saw
 the Railway Exchange Building rotate.

L. N. Rider's idea of no kind of a practical joke is for
 some one to make a hot man's thermometer make him think
 he is really hotter than he is. The said I. N. R. is looking
 for the person who moved the tube of his private thermom-
 eter up seven degrees.

Our picnic was held Friday, June 22nd. There were
 about ninety present. The program included races, tug-
 of-war, ball game, basket lunch, ice cream, lemonade and
 dancing.



The Ladies' 50-Yard Race



Left to right—L. N. Rider, Acting Stores Manager; Miss Marguerite Hill; W. J. Drury, Sales Manager

Sewing shirts for soldiers is inefficient, say some mili-
 tary authorities. It is better to give your money than
 waste your time, they add. But when you use a Western
 Electric Portable—ah! that's different. We show with
 pride that our Dallas Red Cross women are up-to-date.

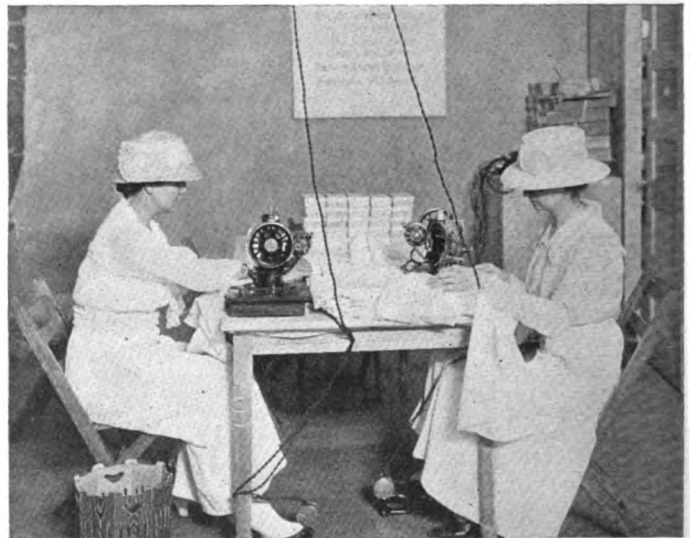

Working for the Red Cross on Western Electric Portable Sewing Machines

Cincinnati

D. E. Smith, Correspondent

Cincinnatians have answered the call to the colors not
 unsparingly, there being five employees of the Cincinnati
 branch who have enlisted in the various branches of the
 United States Army.

J. W. Sheriff has been recommended for a commission
 in the Army Signal Corps.

C. H. Hamilton and H. D. Graessle have enlisted in the
 Third Ohio Ambulance Corps.

E. C. Schlotman and B. P. Tanner have enlisted in the
 regular Army.

Activities of the Hawthorne Club



C. W. Robbins



Mayme Fenn



G. J. DuPlain



F. L. Zimmerman



A. A. Wiltse



May Quinn



Elsie Tilden



J. J. Garvey



R. A. Corris



G. A. Goyett



J. V. Brown

The Club Election

A great amount of time (probably most of it worthless, anyway) has been wasted in disputations on whether "politics is singular," or, "politics are plural." As a compromise we have always inclined to the opinion that "politics are singular." The ordinary garden or dirty varieties of politics are singular because no matter how you vote you help elect an absolutely unfit candidate. Hawthorne Club politics are singular because no matter how you vote you cannot fail to elect a good candidate.

The annual election of the Club was held June 28th, at the close of a whirlwind campaign that made the "sovereign voter" wonder what had become of the old-fashioned paper shortage. The campaign managers of one of the candidates out for a "universal suffrage" office even had sufficient faith in their man's matinee idol qualifications to appeal for the feminine vote by sending out his picture. He won, too.

With all these devices to obscure the issue there was only one thing for the voters to do, and that was to go ahead and vote for the best candidates. Which all of them did, no matter whom they voted for, because there were none but "best" on the ticket.

The final results showed C. W. Robbins elected president; G. J. Du Plain, first vice-president; Miss Mayme Fenn, second vice-president; A. A. Wiltse, financial secretary; F. L. Zimmerman, secretary-treasurer; G. A. Goyett, executive committee (one-year term); J. J. Garvey, J. V. Brown and R. A. Corris, executive committee (three-year term); Miss May Quinn and Miss Elsie Tilden, women's representatives on the executive committee (three-year term).

J. L. McQuarrie Talks on Machine Switching Systems

If ever you are delirious with fever and suffering from an hallucination that you must unravel the mysteries of several circuit diagrams before you can get well, do not—we beg of you, as you value your life—do not choose full mechanical or semi-mechanical telephone switchboard diagrams. We at Hawthorne had the advantage of hearing them explained by an expert recently, when J. L. McQuarrie, of New York, the Company's Assistant Chief Engineer, lectured on "Machine Switching Systems for Telephone Exchanges." Yet even now some of us would not absolutely guarantee to tell you exactly where every wire runs to, and what it does after it gets there. But we did get a very good general idea of the systems from the lecturer's clear and interesting explanations, and that, of course, was all he aimed at giving us in his comparatively brief talk.

By the aid of a series of pictures and very clever diagrams Mr. McQuarrie led his audience, step by step, from the present manual telephone offices, through a small mechanical office of 100 lines, to the complexities of a 10,000-line full mechanical system and, finally, into the type of equipment our engineers have developed.



PART OF THE BIG PRE-ELECTION PARADE

Please Don't Indulge in Witticisms Because the Photographer Happened to Get Gas Tanks in the Picture, Too. Our Candidates Made No Speeches

To add excitement at the finish a big parade was staged at noon on "the big day" in which various candidates bowed graciously to the admiring populace in true statesman style.

Mr. McQuarrie explained in some detail the principal parts of the new apparatus, giving considerable attention to the new selectors, which are quite a departure from present practice, in that the capacity of each unit is 500 lines instead of the usual 100 lines. These switches, which are driven by continuously moving rollers, are controlled by switching devices called registers. In the full mechanical system the movement of the subscriber's dial sets all the necessary mechanism into operation, and the "call" is completed without the aid of any second person.

In semi-mechanical offices each operator's position is provided with a keyboard, similar to the keyboard of an adding machine. These keyboards are connected to the registers and perform the same function as does the subscriber's dial in a full mechanical office.

A number of very interesting pictures were shown of the various types of switchboards which are being developed to adapt the machine switching apparatus to the present manual exchanges.



Changes in Organization

Warehouse and Sales Office for Charlotte, N. C.

THE Company will be represented in Charlotte, N. C., in the future by a warehouse and a sales office at 238 West First Street. R. H. Bouigny will be in charge.

Sidney Greenfield, of the Philadelphia house, will head the sales force of the new Baltimore branch.

Since July 1st W. H. Quirk has been Manager at Cincinnati, succeeding L. T. Milnor.

W. L. Sioussot has succeeded Mr. Quirk as Stores Manager at Cleveland.

A. C. Cornell, of the St. Louis organization, has been appointed Sales Manager at Denver.



W. H. Quirk



Sidney Greenfield

Manager, February 1, 1913, and to Cleveland as Stores Manager, February 20, 1916.

W. H. Quirk

The new manager at Cincinnati started with the Company, working in the shipping department clearing house, March 12, 1905. He was transferred to the Foreign House Sales Department in October and to Chicago to handle Foreign House orders, October 1, 1907. He was made Chief Storekeeper at Cincinnati, July 1, 1908, and took over the chief clerk's work also the following year. Mr. Quirk was transferred to Omaha as Chief Storekeeper, February 1, 1910, and to Kansas City as Assistant Manager, October 1, 1910. He then went to Dallas as Stores

Sidney Greenfield

The man who will head the sales force of the new Baltimore branch entered the employ of the Company in 1903, in the Claim Department, Philadelphia. In 1906 he was made a city and out-of-town salesman. In 1907 Mr. Greenfield was transferred to the Supply Stock Division and three years later back to the Sales Department, becoming Quotation Clerk, then Supply Specialist and General Specialist. His title is now Sales Manager, Baltimore.



When King Albert of Belgium Visited Our Clinton St. Plant

MR. Welles, formerly vice-president of the Western Electric Company in Europe, tells an interesting story of a visit which the present King of Belgium, then Prince Albert, made to America a good many years ago, during the course of which he went through the Western Electric's factory at Clinton Street, Chicago, but not in the manner in which it was intended he should visit it.

It appears that the Prince and his suite were being entertained on a lavish scale in Chicago, one formal occasion following another in rapid succession. A visit to the largest telephone manufacturing plant in the world—which our Clinton Street plant then was—had been planned for the entire royal party, and the officers of the Company were to be on hand with an official welcome and

an inspection of the plant. This visit was set for the early part of the week, but on the Saturday afternoon previous, tiring of all of the ceremony through which he was being dragged, the young Prince broke away from his attendants and walked over to Clinton Street, where he sought admission to the factory. To the watchman on guard at the door he explained who he was; the watchman sought out a janitor, and the janitor was pressed into service, acting as guide to the royal visitor, who went through the shops from top to bottom.

The News has made an attempt to find out the name of the watchman and janitor who were concerned in the visit, but thus far has been unsuccessful. Perhaps this story will fall under the eye of an old employee who will be able to supply some additional facts.

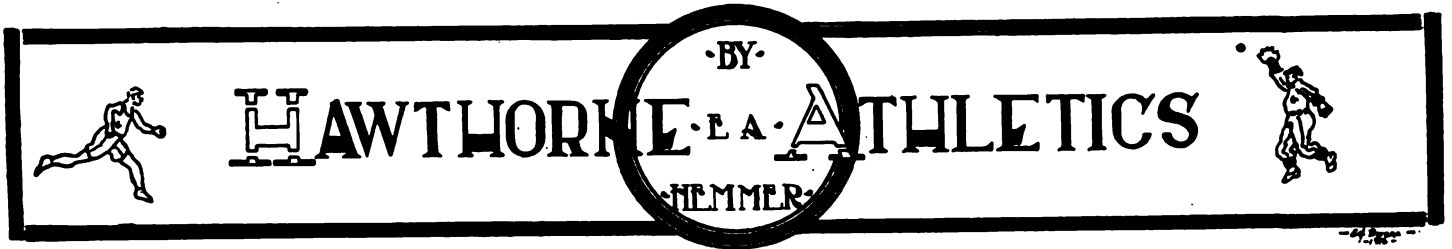

Some of Hawthorne's Heroes of the Horsehide

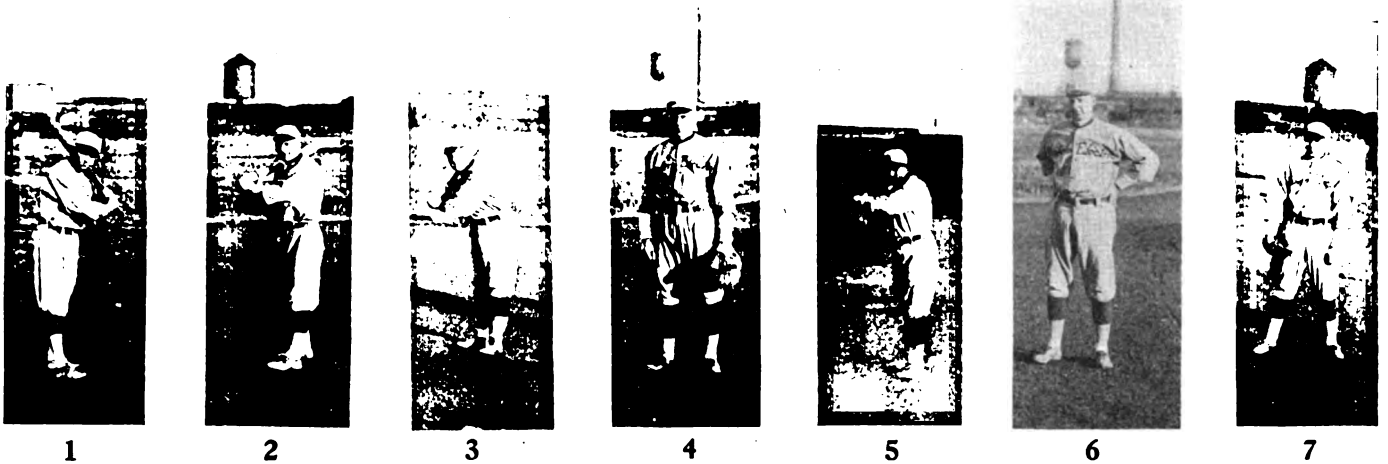

1

2

3

4

5

6

7

1—*R. Madigan, Outfielder*

Spring, 1910—Philadelphia, American League.
 1910—Danville, Three "I" League.
 1910-1911—Bloomington, Three "I" League.
 1912—Keokuk, Central Association.
 1913-14-15—Gunthers.
 1916-17—Western Electric Commercial League Team.

2—*E. Ginnors, Shortstop*

1914—Ottawa, Canada, Canadian League.
 1915—Brantford, Canada, Canadian League.
 1916-17—Western Electric Commercial League Team.

3—*F. Jameson, 2nd Baseman*

1914-15-16—Romeos, of Chicago.
 1917—Western Electric Commercial League Team.

4—*E. Eehor, Catcher*

1912-13—Western Electric Commercial League Team.
 1914—Lincoln, Western League.
 1915-16-17—Western Electric Commercial League Team.
 Property Milwaukee A. A. team.

5—*F. J. Naprstek, Manager and Catcher*

1910—Western Electric Commercial League Team.
 1911—University of Illinois.

1912—Gladstone, Upper Peninsula, Michigan, Wisconsin League.
 1913—Western Electric Commercial League Team.
 1914—Kewanee, Central Association, and Western Electric Commercial League Team.
 1915-16-17—Western Electric Commercial League Team.

6—*L. Fiene, 1st Baseman*

1904—Cedar Rapids, Three "I" League.
 1905—Toledo A. A.
 1906-07—Chicago White Sox.
 1908—Minneapolis A. A.
 1909—Chicago White Sox.
 1910—Minneapolis A. A.
 1911—Toledo and Kansas City A. A.
 1912—Kansas City A. A.
 1913—Kansas City A. A.
 1914—Minneapolis A. A.
 1915—Milwaukee A. A.
 1916-17—Western Electric Commercial League Team.

7—*A. Engelhardt, 1st Baseman*

1913—Riverviews of Chicago.
 1914—Terre Haute.
 1914-15—Kosciuskos of Milwaukee.
 1916—Waukegan.
 1917—Western Electric Commercial League Team.

Tennis Notes

A RECORD-BREAKING number of entries assures the success of the Patriotic singles' tournament, inaugurated this year by the tennis committee. The entry fees are to be turned in for Red Cross memberships and these distributed as prizes to the winners. J. M. Stahr has survived the initial round for the first time in his career. In the second round he will lose to J. W. Latane, 6-1, 6-0. That is not prophecy; it is Latane. Plans for the doubles' tournament, to be run under the same conditions, are now under way, and another large entry is looked for in this event.

The commercial league team finished its season in second place. Sears-Roebuck captured the championship, and Chicago Telephone Company, Commonwealth Edison, and Peoples Gas Company took third, fourth, and fifth place, respectively.

The Chicago Tennis Association has started its 1917 schedule, one round having been played to date. We have two teams entered in this league—a first and a second team. The first team met the South Park Team in the first match of their schedule. The score was 8 to 1 in favor of the South Park Club. However, reporters state that our team made a much better showing than the one-sided score would indicate. Our only point was won by S. Crowley, who came down from the Officers' Reserve Camp, at Fort Sheridan, to play in this match. The captain of the team is considering sending several of the team to this camp to get some training, so that they will refuse to accept anything less than victory in their future matches. The second team had to postpone its first match on account of rain, but the members are strongly entrenched and expect to repel the enemy.

The captain of our team, D. S. Pratt, has been compelled

to give up active participation in tennis for the time being. He will, however, retain his place on the tennis committee, and will coach the team from the side lines.

Numerous skirmishes have been fought in the Class Tournament. J. W. Latane, who was placed in first position, has been able to hold his place so far against all comers. B. W. Huscher and R. D. Berry both tried to dislodge him from his place, but with no success. Some of the scores in the tournament are:

Langbrough defeated Cook.....2-6, 6-0, 6-2
 Latane defeated Huscher6-4, 4-6, 6-3
 Orwick defeated Hess.....6-1, 6-2
 Latane defeated Berry.....6-1, 6-4
 Biggar defeated Cook.....6-3, 6-7, 6-1
 Cook defeated Hess.....6-4, 3-6, 6-2

At press date the standing of the first two classes in the class tournament was as follows:

Class A

- J. W. Latane
- S. W. Baldwin
- J. H. Biggar
- B. W. Huscher
- C. A. Cook
- L. W. Langbrough
- R. E. Orwick
- A. C. Jones

Class B

- R. D. Berry
- A. C. Johnson
- E. H. Hess
- F. P. Hutchinson
- G. L. Henry
- C. D. Hart
- L. T. Hamlin
- O. E. Kellburg

Commercial League Baseball

On Saturday, June 23rd, a seemingly easy game had an interesting ending. After trailing for eight innings the Speedometer boys got to Maager, after he spoiled a double play, and Williams was substituted. He was nicked for a couple of hits and, finally, Cantwell was sent to the rescue. He struck out the last man with the tying and winning runs on third and second, waiting to be scored. Box score below:

Western Electric Company					Stewart-Warner Company						
	R.	H.	P.O.	A. E.		R.	H.	P.O.	A. E.		
GINNERS, 3b....	1	1	0	6	0	A. Tebbins, 3b..	0	0	0	4	1
Fox, rf.	0	0	0	0	0	B. Tebbins, 2b..	0	1	4	3	1
Kavanaugh, lf..	0	0	2	0	0	Kavanaugh, ss.	1	2	3	2	1
Fiene, lb.	1	1	7	0	0	Darling, lb. ...	0	1	12	0	0
Tennant, 1b. .	0	0	5	0	1	Bein, cf.	0	3	1	0	0
Swanson, cf. .	0	0	0	0	0	Roderman, lf... 1	2	2	0	1	
Madigan, cf. .	0	0	3	0	0	Fleming, rf....	1	0	0	0	0
Evans, ss.	1	1	0	2	0	O'Malley, c. ...	1	2	2	2	0
Chouinard, 2b..	2	1	4	0	0	Nelson, p.....	1	1	0	5	0
Rehor, c.	1	1	6	2	1	Totals	5	12	24	16	4
Young, p.	0	1	0	3	0						
Maager, p.	0	1	0	2	0						
Williams, p. ...	0	0	0	1	0						
Cantwell, p. ...	0	0	0	0	0						
Totals	6	7	27	16	2						

Western Electric Co..... 2 1 0 0 0 0 0 3 *-6
 Stewart-Warner Co. 0 0 0 0 0 0 0 1 4-5

Two-base hit—Roderman, Bein, Fiene, Maager. Three-base hit—O'Malley, Young, Rehor. Stolen bases—Chouinard 2, Tennant. Bases on balls—Young 1, Maager 1, Nelson 5. Struck out—Young 3, Maager 2, Nelson 2.



FOREIGN NOTES

SOME ITEMS OF INTEREST FROM ABROAD

New York



Seth Ljungquist

On July 5th General A. P. Zalubovsky, head of the Russian Military Commission in the United States, and five members of his staff—Col. G. S. Dunajvsky, Col. V. I. Zavisha, Col. I. A. Sidorkine, Lieut. K. M. Alexeieff, and Electrical Engineer G. G. Poretika—visited the engineering and chemical laboratories at West Street, making a careful inspection of the work. The News photographer was fortunate in being able to photograph our distinguished visitors just after the completion of their inspection trip.

Mr. Seth Ljungquist, Chief of Division of the Royal Swedish Telegraph Administration, spent some time with

us recently. It was a great pleasure to have Mr. Ljungquist with us. We wish him a safe voyage home and look forward to seeing him here again.



The Russian Military Commission

Western Electric

Vol. VI. No. 7 *News* September 1917

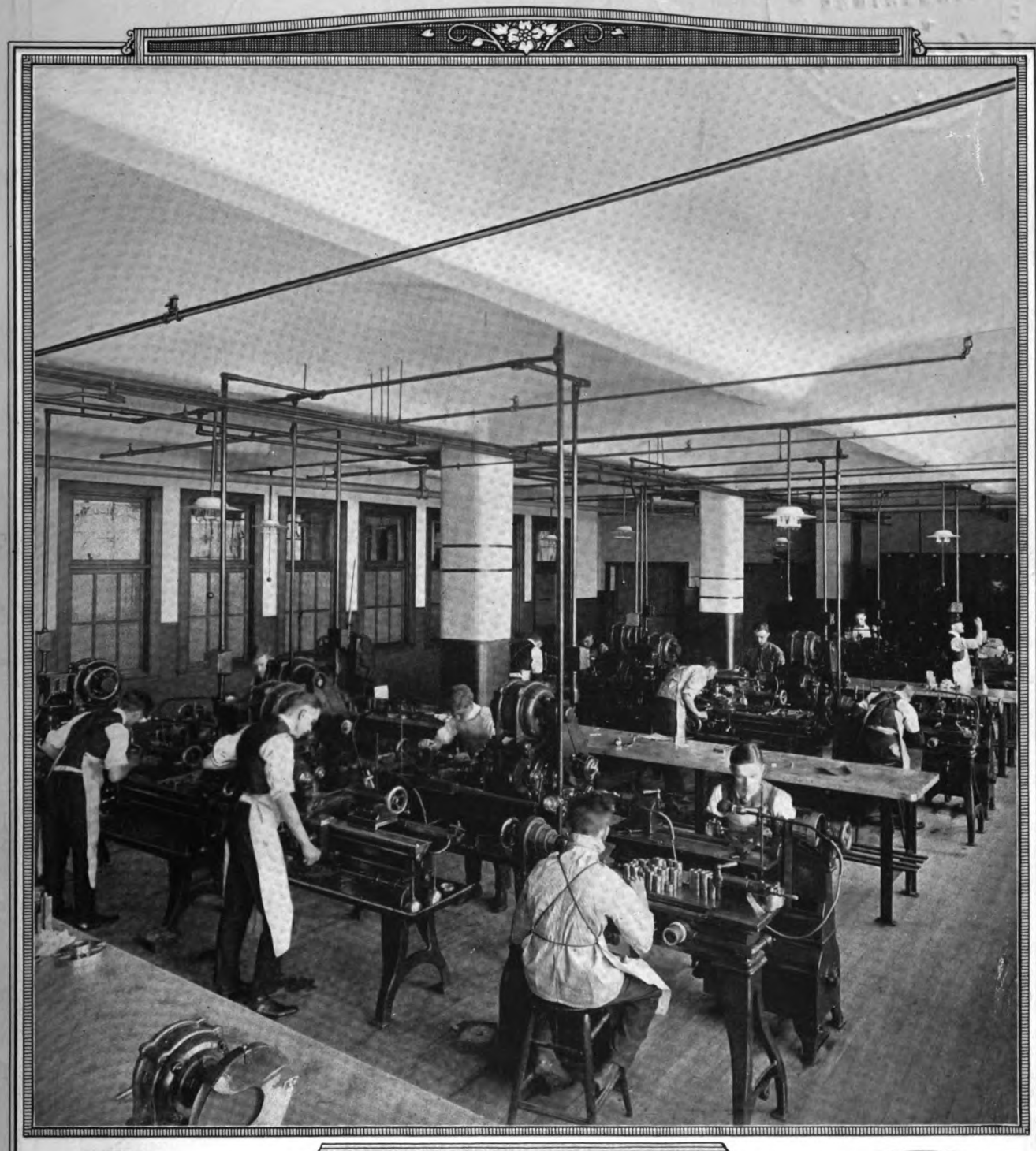

**SCHOOL DAYS
IN BUSINESS**

Fellner

Why Shouldn't Your Wife Sew This Way?



She can with a **Western Electric** Portable Sewing Machine

Anywhere, any time, she can sew with this machine. For it is no larger than a typewriter. She can carry it to the living room, or to the porch. Put it away out of sight on a closet shelf when through.

Simple: A touch of the foot starts the motor and accurately regulates the speed. There's nothing complicated to puzzle her. It connects to any socket and runs on any current.

Capable: A standard machine, complete in every particular, it sews the heaviest or daintiest materials and has all of the regular attachments.

Economical: Even costs less than the old-fashioned, pedal-power machine—only \$35.00 (\$37.00 West of the Rockies). A cent's worth of electricity runs it 3 hours. Saves energy and strength. Works faster, too. She'll like it.

If your lighting company or electrical dealer cannot show you this new kind of sewing machine, write to nearest office for Booklet No. S-517

WESTERN ELECTRIC COMPANY INCORPORATED

New York

Chicago

Kansas City

San Francisco

Houses in all Principal Cities

This Advertisement, which is to appear in *World's Work* for September, is part of the fall advertising drive on portable sewing machines



SEPTEMBER, 1917

VOLUME VI, NUMBER 7

Learning the Job

Educational Opportunities Open to Employees

WHEN Charley Sanger finished at the Technical High School he found himself up against a hard proposition. Of course, he had worked every vacation at odd jobs, and had earned quite a little money, but just what kind of a regular job he could get now—that was the question. He liked to draw; he had done well in his draughting course and in his mathematics—it was easy for him. He talked with the professor, and they agreed that if he could get with a company that "helped their men to learn the business" draughting would be a good place to start.

But the Western Electric's draughting work isn't just the same line of problems that the course at school covered. The Engineering Department knows that. It knows, too, that it's good business to help Charley Sanger to find out where the differences are. Charley found himself in the big draughting room with a real job on his table. But what was it all about? How could you expect a fellow to do a good job if he didn't understand it? "Helping boys understand it" is Mr. Thomas' job in the Equipment Engineering Department at Hawthorne. The telephone business is a big business. Some of us have one part to take care of—some another, but they all have to fit together. So week after week, a variety of work, talks by Mr.

Thomas, visits in the shop where parts are being made and some time "out on the road" with the installers, give a new man a chance to find out what it is all about. And so Mr. Thomas watches and helps here and there, always on the job and by-and-by a fellow begins to get it straightened out—what a cable rack is for—why the big switchboards for 10,000 subscribers' lines have to be so carefully planned, what the engineers mean when they talk so wisely about relays and circuits. Every time the class meets, some new questions are settled. "It isn't like school"; a fellow gets paid for going and is using what he learns right away.

If Charley Sanger had been more interested in the mechanical end and decided he wanted to be a tool designer, he would have found just as good a plan already mapped out for him. It includes two years on machine and bench work, making tools and then the draughting work after that.

Chris Slama "always did like to make things." That's the reason he wanted to get into the shop where the "wheels go around." Chris was already working for the Western in the Milling Department, when he heard about the tool makers' apprentice course. He went down to see Mr. Garvey and they talked it over. This Mr. Garvey

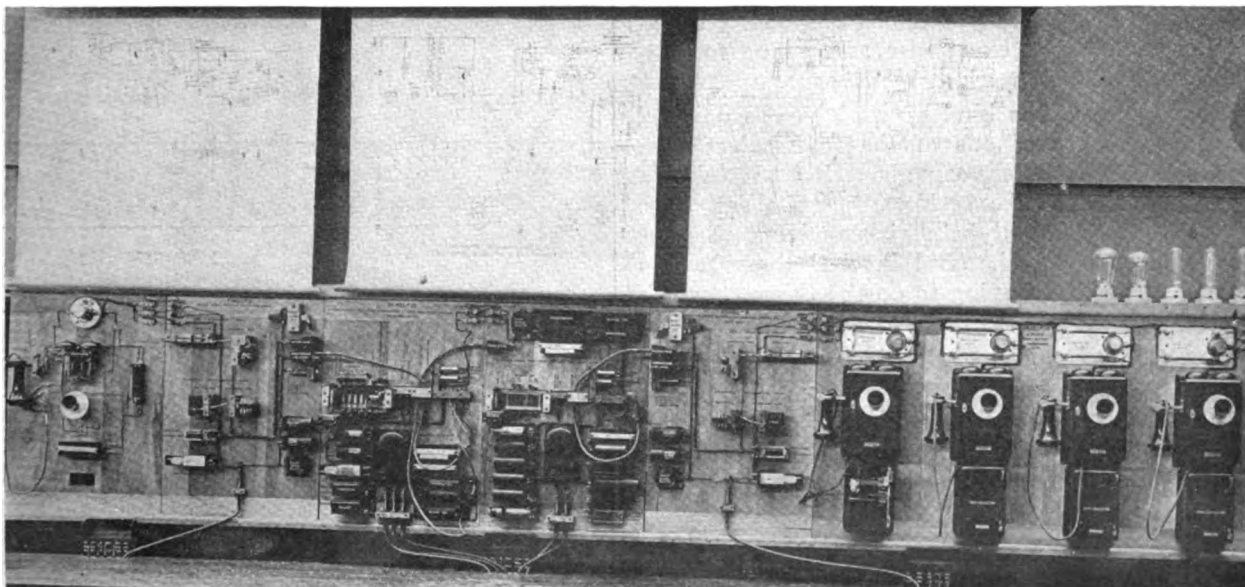

Demonstration Circuits. They Make It Easy to Understand How the Telephone Works

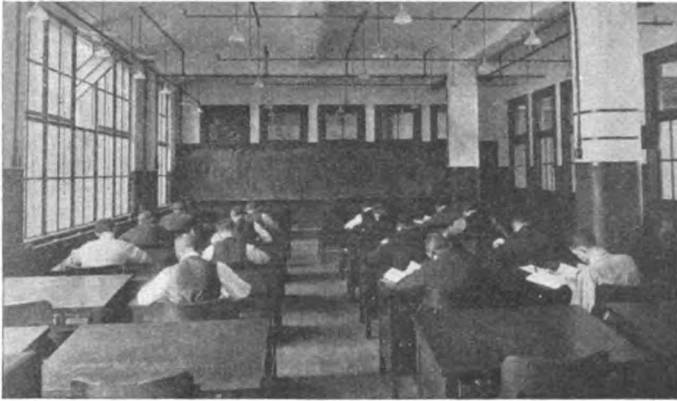

CONFERENCE ROOM, WORKS TRAINING DEPARTMENT

AN APPRENTICE USES HIS HEAD AS WELL AS HIS HANDS

seems to have "some notions" about who has the stuff in "em" to make tool makers. If a fellow's better cut out to drive a truck—Garvey will find it out. Chris found it wasn't any cinch to get on that course.

There was a waiting list of boys from all over the shop and some in the offices, and then some more working at other places who were anxious to take a four-years' course of training to learn to be a first-class tool maker, earn \$2,300 in four years, get \$100 bonus, and, better yet, be able to hold down a journeyman's job with a journeyman's wages at the end of the course.

Chris was rusty on his figuring, but he brushed up and passed the second examination all right. When his time came, he got a transfer from his foreman and started in the instruction shop. He worked for a few weeks in the tool crib and then on one of the machines. He got wise quickly because the instructor only had about a dozen other fellows to help to learn the work and how to do it right. After that he went up to the big tool room and showed them what he had learned and that he could use it on their kinds of jobs as well as the ones in the apprentice shop. Those shop problems and sketches that Mr. Sittig went over with the class down in the conference room—kept bobbing up in the shop just when a fellow was needing some help on laying out a new job. It's interesting work and good experience and a fine foundation for a lot of kinds of work at Hawthorne.

"How can I get on the kind of work you're doing?" asked Mayme Gaither of one of the foremen's clerks. "Better talk with your foreman about it." It takes a knack for figures. Mistakes? No. Speed? Yes. Mr. Carney has some tests that help girls find out whether they have a chance to make good in clerical work. No one wants to waste time trying to do the thing at which there is not an even chance to make good.

There are a lot of numbers and piece-work prices and some of the jobs run 7¾ hours and some 1½ hours, and some start at 8:30 and run to 1:15 with 45 minutes out for lunch—and some have to be recorded on pink tickets and some on yellow ones, and some have two copies and some have four copies. If you like it and can do it well—it's fun—and that's Mr. Carney's job to find out and then to help those who can do it to do it better; and those who can't, to find another kind of work at which they can make good.

The Office Boy Has a Chance

It takes a while for a fellow "to get into the game." When it's a big game and a fellow is only about sixteen and just out of grammar school, it is asking a lot of him to locate all the bases and learn the rules in a few days. Sometimes even the boss forgets that a lad who's been playing third with a team all season and has come through to the championship series, does not look at the boss's big game as of equal importance. It is a wise boss who can see that loyalty to the team transformed into loyalty for the firm. But the boss has got to be a good scout and not expect too much from his youngsters the first season.

Government orders and rush jobs and schedules, and all that are the boss's game and will be the lad's game, too, when he learns the rules. Helping boys learn the game is a job for a good coach and the office boys' training plan has all the bases marked and coaches on the bench all the while.

"I saw your ad" in the News. "I want to learn to install telephone exchanges if there's a chance for me." "We are going to take some new men over to the Franklin Exchange this afternoon," replied the head of the installation school. "Come along and you can see for yourself what the job is like. Here in this shop we will teach you the things you need to know right at the start—how to butt cable, how to sort out the wires, how to sew them into the forms and solder them to the apparatus. It takes two weeks and then we'll send you out on a job. If you make good after you have had some experience, we will bring you back to learn some other parts of the installing work." There is a lot of difference between letting a man learn a business and helping him to learn it.

Throughout the company in all of its work, these plans are working; some for typists, some for office boys, foremen's clerks, draughtsmen, toolmakers, machine operators, engineers, technical men, installers. Wherever new people are being taught old jobs or old people are learning new jobs, systematic instruction is taking some of the element of chance out of "learning to earn."

W 248-A (9-17)

SPEED _____ IN ONE MINUTE TEST NO. 1 NAME _____

ADDITION DATE _____

•	7	•	•	•	•	7	•	•	•
•	•	•	•	•	•	•	•	•	•
•	•	•	•	•	•	•	•	•	•
•	•	•	•	•	•	•	•	•	•
•	•	•	•	•	•	•	•	•	•
•	•	•	•	•	•	•	•	•	•
•	•	•	•	•	•	•	•	•	•
•	•	•	•	•	•	•	•	•	•
•	•	•	•	•	•	•	•	•	•
•	•	•	•	•	•	•	•	•	•

One of the Addition Tests

An Educational System

These things haven't just happened. Getting the right people into the right jobs and the wrong people out of the wrong jobs is an important part of every executive's work. The company recognizes it as just as much a part of its business as making telephone and cable and switchboards and then selling them. The Company's educational department, the training organizations at Hawthorne and in the engineering department at New York, the installation schools in the principal cities, the employment departments—these are all parts of the company's organization which are trying to get us into the places where we can get the most fun out of our every-day jobs and render the best service.

Back of these departments which have the responsibility for putting the plans into effect is a system of advisory committees. You might call them the "school boards" for the company and the general departments. Let's see what is expected of them.

The whole system heads up through Vice-President Halligan, who appoints the company's general educational committee. This plan has grown out of the company's experience extending over a number of years. Those have been extended gradually so that now the training and development of employees in all phases of the company's business is looked upon as a distinct and vital part of the company's work. At the present time the company's general educational committee is made up of representatives of the General Manufacturing, Engineering and General Sales Departments. R. C. Dodd, Operating Superintendent, is Chairman, and J. W. Dietz, Educational Director, serves as Secretary and gives his full time to the work. Other committee members are: J. Danner, Equipment Engineer, and R. L. Jones, Transmission Engineer, representing the Engineering Department; J. J. Garvey, Works Training Department, and Mr. Dodd, representing the General Manufacturing Department; and from the General Sales Department, E. A. Hawkins, Telephone Sales Manager, and P. L. Thomson, Advertising Manager.

The following outline gives an idea of the duties and scope of the committee's work:

1. To make recommendations regarding the Company's educational policies and methods.

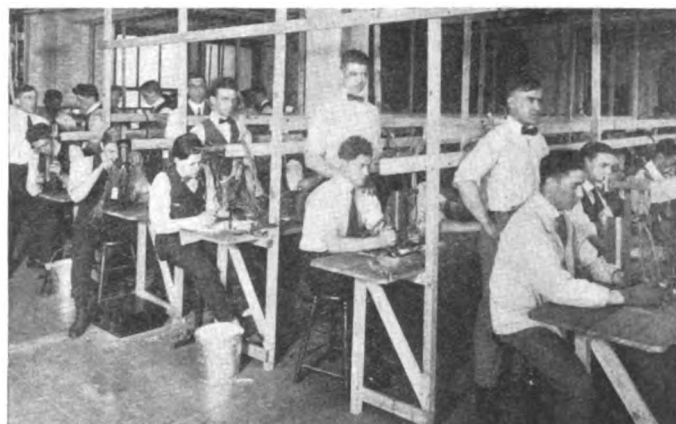

One of the Schools for Installers. Almost 1,000 Men of the Installation Department Have Taken the Training

2. To direct the educational courses so that they are arranged and correlated with regard to the requirements of all departments.
3. To maintain relations with educational institutions so that we may secure a fair share of the desirable graduates.
4. To cooperate with the foreign houses in carrying on similar work abroad.
5. To study matters of interest in connection with industrial and commercial education.

There are in each general department a great many problems similar to the ones which come before the general company committee, but of interest only to the department. These matters are dealt with by educational committees of the department. In order that the work of these committees be properly correlated, the members of the Company general committee serve also on the departmental committees. The sorts of problems which they take up are best shown by the instructions which have been issued to them:

1. To study the various educational needs of the branches of their department.
2. To make recommendations regarding the department's educational policies and methods.
3. To make recommendations regarding the education and development of employees through instruction, lines of promotion or transfers.



Some of the Office Boys at Hawthorne. Every One a Live Wire

4. To co-operate with and recommend to the Company's general educational committee in such matters as affect the Company as a whole.
5. To maintain relations with local educational institutions of less than college grade so that we may secure a fair share of the desirable graduates.

Broadly, three kinds of educational matters will come before these committees:

First—Regarding required instruction or training which is deemed necessary for the proper performance of the Company's duties or such educational work as is carried on during regular working hours and at the Company's expense. This instruction may embrace work along either general or specific lines.

Second—Regarding voluntary instruction or training which is considered advisable and desirable for the employees, and which is entered into by them on their own initiative.

Third—Plans carried on in co-operation with public educational institutions.

The following are serving on departmental advisory committees:

GENERAL MANUFACTURING DEPARTMENT

J. J. Garvey, Chairman, Works Training Dept.
W. F. Hosford, Mechanical Methods Dept.
C. W. Robbins, Inspection Dept.
J. R. Shea, Production Methods Dept.
H. D. Agnew, Employment Dept.

GENERAL SALES DEPARTMENT

E. A. Hawkins, Chairman, Tel. Sales Manager.
H. R. King, Power Apparatus Sales Manager.
P. L. Thomson, Advertising Manager.

ENGINEERING DEPARTMENT

R. L. Jones, Chairman, Transmission.
J. J. Lyng, Design.
A. F. Dixon, Design.
H. D. Arnold, Research.
J. Danner, Equipment.

EQUIPMENT ENGINEERING COMMITTEE

J. Danner, Chairman, Equipment Engineer.
J. Harper, Chief Draughtsman.
H. W. Mowry, Standardization.
C. M. Smith, Editing.
F. L. Zimmerman, Clerical.

These committees and the Company's plans for carrying out the plans and policies agreed upon make a very complete and effective organization for working out the training of employees in ways which are good for both the men and the Company.

The whole spirit of this work is to make it easy for the man or woman who is not satisfied with his ability to increase it along the best possible lines. Every one of us has to know certain required things about our work. We could not hold our jobs unless we did, but for the ambitious employee who seriously endeavors to gain a better mastery of the work for which he or she is fitted the training school courses are indeed a boon.

At Hawthorne, the members of the Hawthorne Club will soon be starting the fifth year of their evening classes. There will be classes in drawing where one may learn to make shop sketches and get more familiar with the reading of blueprints. Problems in mathematics and mechanics just like those that come up every day in the shops and offices are studied with the help of experienced instructors. Other groups study typewriting, electricity and magnetism, telephone practice. Many have found the classes in English, manufacturing principles and production methods helpful and interesting. Over 800 Hawthorne employees took advantage of these courses last year.

Local Opportunities for All

There is no reason why groups of employees should not get together to study subjects of common interest in connection with their part of the Company's work. The Engineers' Club at New York is making such plans. Dallas, Pittsburgh and St. Louis have already found such groups worth while. Talk it over with your manager or department head and get the advice and help of the members of the educational committee for your organization.

There is a lot of advantage in getting together in groups for study, with the help of a leader who will try to clear up the points that are confusing. There are now in all the largest cities opportunities to take up evening study in the public schools or the Y. M. C. A., and subjects that



E. C. Dodd, Chairman, General Educational Committee.
Other Members Below



J. J. Garvey



R. L. Jones



E. A. Hawkins



J. Danner

are useful in connection with your everyday work are the ones which will be most interesting. In most cities the public evening schools have a standing offer to start a class in any subject that is requested by twenty people.

Some of our Western Electric family is so scattered that getting into study groups with other employees is out of the question. It may not be convenient to take up study work in public evening classes or maybe the subjects are not ones that fit into your plans. Don't overlook the public library and the book store. None of us use the public libraries as fully as we should. A trained librarian

will gladly give the help you often need in selecting a book to fit your needs or working out a plan for systematic reading during the winter.

Every one of us has to answer the question, "How am I going to improve my leisure time this winter?" A share of it should be spent in recreation, and then certainly at least a few hours each week "learning something useful on my job." The surest way is to make your plans now. Start early in the fall and come through with at least one subject better understood. The efficiency and success of our Company is just the total of our individual usefulness.



MILITARY NEWS

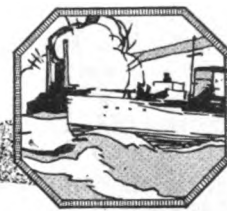

WHAT OUR BOYS IN THE ARMY AND NAVY ARE DOING

Delany's Exciting Trip

George L. Delany, of our St. Louis house, whose sailing for France the NEWS recorded in its last issue, did not suffer from *ennui* to any great extent on his voyage over. His letter tells why:

T. K. Stevenson,
St. Louis, Mo.

DEAR BOSS:

We are now about 2,000 miles off Sandy Hook. Our ship carries plenty of guns. Many naval gunners are on watch continually, in addition to eight ship's officers. We expect a gunboat to meet us this afternoon and convoy us to the Irish channel. Tonight is the really dangerous time and we have instructions to sleep on deck in all our clothes with the life belt on. One deckhand I was talking to the other day has been torpedoed twice and doesn't seem to mind it in the least. He was on the *Vacuum* when she was sunk, and saved himself by lashing two deck chairs together.

If we only can see the U-boat before she launches a torpedo, we will get her sure, as our gunners during practice yesterday were able to hit ordinary barrels dropped astern at a distance of a mile.

Have setting-up exercises and drill every day and I'm feeling bully. Haven't been seasick at all, in spite of a very severe squall two days ago that made the ship almost stand on end.

(Later—Saturday, the 26th, 5 A. M.)

A real experience! About 4 P. M. yesterday after lifeboat drill a sailing vessel was sighted off the port bow. Our course was immediately changed and we started zig-zagging. The sailing vessel followed, but was about out of sight when one of the deckhands cried out: "Periscope." Off the port bow about 1,000 yards ahead a periscope could be seen. We immediately swung to the starboard, putting the U-boat in the rear of us. Before the aft six-inch gun

could be trained on her she submerged and was not seen again. The sailing vessel probably was acting as the base for several U-boats. We at once wirelessly the *Carmania* and the *Mongolia*; both are following us within a hundred miles or so. We also asked that convoy of gunboats be rushed.

Lifeboats were lowered even with decks and everyone was instructed to carry their lifebelts with them and not to undress at all during the night. Many slept on deck, but some of us went to sleep leaving instructions to be called at 3:30 A. M., as that is the beginning of the really dangerous period of the day.

With best regards to all.

Very sincerely yours,
GEORGE L. DELANY.

Extra!—First Official Photograph of the "News" Being Read on Shipboard



We are indebted to C. W. Bergquist for this photograph showing W. R. Boehme and Max Unger, Western Electric boys, now stationed aboard the U. S. S. *Indiana*.

The following extract from a letter to Mr. Bergquist indicates that the NEWS is getting into the war like all the other institutions in the country:

"I received the WESTERN ELECTRIC NEWS you sent, and thank you very much for your thoughtfulness. It arrived at an opportune time as the picture of Max Unger and myself indicates. As soon as we received the copies we beat it from our part of the ship to the forecandle and stowed away while we gave the interesting contents the 'double O.'



Camp Scene at Rookford, Ill. Sent Us by Corporal A. Solhem, Department 5540, Hawthorne



From France

Madeline Evans, the writer of this interesting letter from the war zone, and Jane I. Rignel, whom she mentions, were, until a few months ago, nurses at 463 West Street.

British Expeditionary Forces, France.

MY DEAR MR. GILMAN:

A letter from my aunt in East Orange a few days ago brought us word that the Western Electric Company had very kindly notified her of our safe arrival in London, and I want to thank you sincerely for your thoughtfulness, for I am sure it was a great relief to our families to have a prompt personal message like that.

We had a wonderful week of sightseeing in London, but were really glad when the order came to move on and get to work. Nothing could be lovelier than this spot where we are located—a quaint little village, the sea and marvelous cliffs in full view all the time and plenty of charming country to explore 'round about. There are golf links and tennis courts available when we have time to use them—all of which sounds very frivolous when we are supposed to be taking care of the wounded.

I believe Dr. Grace has written you since we arrived here, so he has probably told you something about the hospital. It is twice the size (in number of beds) that we expected, but just at present things are rather quiet, so we have had a chance to get our bearings and learn the routine with some degree of comfort. We have had two convoys of wounded (numbers not permitted by the censor) and, of course, that keeps everybody busy for several days each time, but they have such a wonderful system of sorting and evacuating that there is almost no confusion. We are disappointed not to have any French among our patients, but they have a separate hospital of their own and we must be content to practise our "parlor Francais" on the villagers. Miss Rignel has been put in charge of one of the big surgical wards, and I have a convalescent block, one house of which is reserved for the Germans.

Miss Rignel joins me in kindest regards to you and all our good friends at the Western, with renewed thanks for all that you have done for us.

Very sincerely yours,
(Signed) MADELINE EVANS.

June 20, 1917.



Left to right, top row: H. H. Hix, C. V. Weaver, W. W. Lowery. Bottom row: O. Whitmire, T. G. Müller, J. C. Stepp. They Are Atlanta Employees Who Have Enlisted in the "Ninth Telegraph Battalion Signal Reserve Corps" Now Being Organized by Major Geo. J. Yundt, Chief Engineer of So. Bell T. & T. Co.

R. A. Tilley of Chicago's Purchasing Department, who has been a member of the First Illinois Cavalry and who saw several months' service on the Mexican border with the Illinois boys last summer, transferred his affiliation to the Regular Army. Mr. Tilley was a sergeant in the Illinois National Guard and becomes a sergeant in the Third United States Cavalry, now stationed at Brownsville, Texas.

George I. Nielsen, of the Chicago Claim Department, has enlisted in the United States Navy. Mr. Nielsen has previously had experience in the Minnesota National Guard from 1911 to 1914, and while a member of that organization qualified as a marksman and also as a sharpshooter. Previous to his connection with the Western, Mr. Nielsen was engaged in electrical contracting business at Ironwood, Mich., and his familiarity with electrical work will qualify him for work of electrician in "Uncle Sam's" Navy. His friends at Clinton Street gave him a rousing send-off.

Earl Brunswick, formerly with the Cleveland house, is at present stationed at Fort McKinley, Maine, where he is training for European service.

J. M. Bateman, manager of the Cleveland house, recently received an interesting letter from the young soldier. That he is enjoying army service is best illustrated by the following paragraph from his letter:

"I am still enjoying army life and am getting plenty to eat and plenty of sleep. One thing I am thankful for is, I don't have to drill one-half as much as I used to."



Earl Brunswick

At the left, Thomas E. Williamson, formerly of Department 6435, Hawthorne, at Fort Sheridan, learning to be an officer.



R. J. Ambler, Catalog Division, Advertising Department, has been accepted for the second Plattsburg encampment. He reported for duty on August 23rd.

THE COMPANY'S GIFT TO THE RED CROSS

During the recent great drive to provide funds for the American Red Cross Society.

the Western Electric Company made a contribution of \$50,000.

How Did the Steel Magnet Get Such a Pull?

ANOTHER DEMONIACAL DEMONSTRATION

By S. A. Menutt

*Majestic in his padded cell
The transmission bug prefers to dwell.
He listens, listens, all the while,
Imagining he can detect a mile.
Ears developed to an awful size,
Dome swelled up in manner likewise.
"My dictum's final," loud he cries.
"Let no one dare to criticise."*

*Fret not thy gizzard, reader dear,
He gets this way 'most every year.
Anon you'll see him writhe in pain.
The shop will soon slip one over again.*

"DISGUSTINGLY undignified."
"Alleged humor."
"Disgraceful."

Poor Mr. Menutt looked deeply chagrined and hurriedly folded the magazine from which he had just read the offending doggerel.

"I can't see why you highbrows are so prejudiced against a little harmless joshing," said he.

The three gentlemen thus addressed were quite annoyed, and one said:

"I consider that magazine a disgrace to this club. I am ashamed to see it here beside the dignified and worthy contributions to science and art such as you may see on that table."

"I entirely concur," said another, "for example, take the *Snooze*, published by the Amalgamated Comical Company. How dignified and technical are articles one reads there; I cannot imagine anything so frivolous and degrading as 'joshing' in the *Snooze*."

"No, I can't either," said Mr. Menutt meekly, "but we can't all be highbrows. There wouldn't be enough grape-nuts to go 'round."

"A flippant answer, without scientific value," said the highest highbrow of the three. "That sort of talk is quite characteristic of a type of unintellectual people who read trashy newspaper humor."

Mr. Menutt hesitated, because to enter into controversy with so prominent a member of the fraternity was a very hazardous procedure. He swallowed several times, blinked his eyes rapidly, and said, "Please, Professor Rush, tell me how you recognize Real Humor when you see it."

The professor's chest expanded perceptibly.

"Humor," he said, "must first of all be dignified. Then it must always be clear and concise; and lastly, it must never be slangy."

"I bet if you rewrote that little verse it would be awfully funny," said Menutt. "Won't you try just to prove you can do it?"

Professor Rush, although momentarily nonplussed, rose to the challenge.

"But, my dear Menutt, I don't believe in humorous poetry, at least not for magazines circulated in this club."

"Well, never mind that; just for scientific purposes let us suppose that you do believe in humorous poetry. Why not let us see what this little jingle would sound like if you rewrote it in accordance with your definition!"

The other two looked uncomfortable, and Professor Rush felt that they expected him to make such an answer as would relieve the tension. So, picking up the offending magazine, he said, "Oh, very well, I'll just step into the library for a few minutes and dash something off."

Menutt ordered three more cups of tea, and as this was being served the other two highbrows recovered from their shock at his presumption.

"While the professor is busy, I wish one of you fellows would explain something to me. I have never been able to understand how a piece of steel like this," taking a small horseshoe magnet from his pocket, "can pull another bit of steel or iron along the table without touching it."

"Oh, that is very simple," said Dr. Smith, "that is due to the force of magnetic attraction."

"Yes, exactly," said the other, who usually signed his name "R. U. Onn, Physzle Researchist."

"Well," said Menutt, "I'll admit that is humor of a sort, but I don't think it would appeal to anyone but a highbrow."

"Humor. What are you talking about? I said nothing humorous. You asked me why a magnet exerted a pull on its armature, and I replied that it was due to the force of magnetic attraction. What is humorous about that?"

Menutt gasped, but finally composed himself sufficiently to say:

"Excuse me for misjudging you, but can you tell me in plain words that any man can understand just how a magnet works?"

"Well," said Mr. Onn. "Of course, if you do not understand Physzselics it will be very difficult to explain it to you. Why do you try to delve into matter entirely out of your line?"

"Do you mean to say that you cannot explain it except to someone who knows as much about it as you do?"

"Not at all," said Onn, "but a knowledge of Bunkology or Physzselics is necessary in order to understand the terms I would use in the explanation."

"Well, I know nothing about Physzselics or Bunkology. It's all Greek to me. What I want to know is: do you know how it is that a piece of steel acts so different from a brick or a piece of wood? Let's hear the answer in plain United States. Where does the magnet get its pull?"

Smith looked at Onn, and Onn looked at Smith. Finally the latter said:

"But, my dear Menutt, how can we explain it to you when you don't even understand the language?"

"The force of magnetic attraction means nix in my young life," said Menutt. "How does it work? Tell me on the level—do you highbrows really know?"

"What's that?" said the deep, resonant voice of Professor Rush, who had returned from the library unnoticed by them.

"Oh, hello, professor. Let's hear what you 'dashed off.'"

"Well, of course, you must make allowance for haste. You could not expect much in so short a time. Here's what I have written:

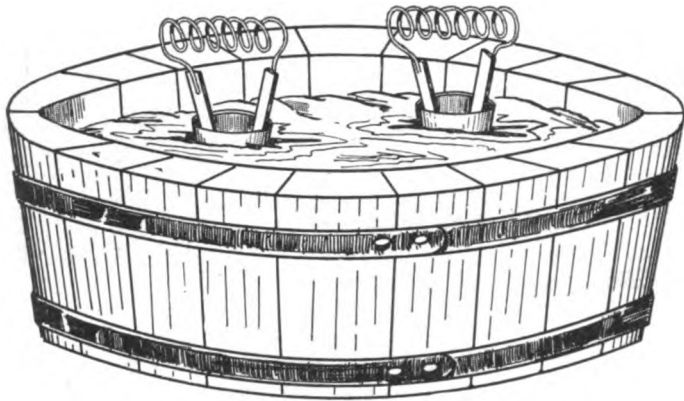

Figure 1.

*serene, supreme, in his soundproof station,
The transmission expert pursues his vocation.
Long training has so developed his aural sense
That he commands respect in consequence.
Bunkology, Physzselics, and things of that kind,
Beautiful theories of the Cloistered Mind,
Are matters above manufacturing conception,
Hence our indifference to their reception.
That facts may annoy we know to be true,
But we rise far above for a broader view,
So practice and theory often make a rough house,
But end up together like the Lion and the Mouse."*

"Immense," said Menutt. "That meets your definition exactly, except that 'rough house' is undignified and slangy and the last two lines are far from clear or concise."

"Well, maybe so," said the professor, "but I got nervous toward the end and felt obliged to take a little refreshment, which probably accounts for the falling-off in scientific quality."

"I think, considering the inconsiderable interval during which the professor has been absent, that that verse is indicative of a marvelous mind," said Dr. Smith.

"Well, professor, I'm willing to call it a draw if you are," said Menutt. "I'll admit it is more dignified than the first one, and it's funnier than you realize. Besides, I want to talk about something else."

The professor stared sharply at Menutt, and then said:

"Very well, sir, I accept your apology. What is it that you wish to discuss?"

"I want to know how a magnet works, and from the line of hot air I have been getting from Smith and Onn, I'm suspicious that they don't know themselves."

"Impudent ignorance," said Dr. Smith. "The man's cerebrum is of microscopic dimensions. How can we make him understand, when he confesses that the principles of magnetic attraction mean nothing to him?"

"I see," said the professor, and turning to Menutt he took a long breath preparatory to speaking.

"As is usual with the lower order of mentality you have failed to specify what kind of a magnet you mean, but I am able to deduce from that which you have in your hand that you have in mind a permanent magnet of the horse-shoe shape. Now the fundamental law of attractive force is as follows: At any element of surface of iron or steel at which the flux enters or emerges perpendicularly, the attractive force in dynes, exerted upon the element, will be the product of the elementary surface area into the square of the flux density, in gausses, divided by 8; that is $dF = dS B^2$ dynes. Where B is the normal flux density, dF the element of attractive force, and dS the element of surface in centimeters; and this force will be ex-

erted along the flux paths, or perpendicular to the surface. Now you can easily see that the important factors in this quadratic expression are B, the flux density and the area. The fundamental equation for flux density is

$$\begin{aligned} \phi &= F \\ &\frac{A}{R} \\ \text{Where} \quad \phi &= \text{Webers} \\ F &= \text{Gilberts} \\ R &= \text{Oerstedts} \end{aligned}$$

from which you see that the pull depends on the magneto-motive force divided by the reluctance which, in turn, is a function of the area again; that is, the area enters twice. Now——"

"Help! Help!" shouted Menutt, frantically waving his arms at a tall man who had just appeared in the doorway. "For God's sake, save me, Ashpit, I'm being drowned in Highbrowlogy."

As the newcomer walked over to the table the three highbrows rose from their chairs and salaamed solemnly.

"Good evening, sir," said the three, in a respectful chorus. To which he replied with equal dignity.

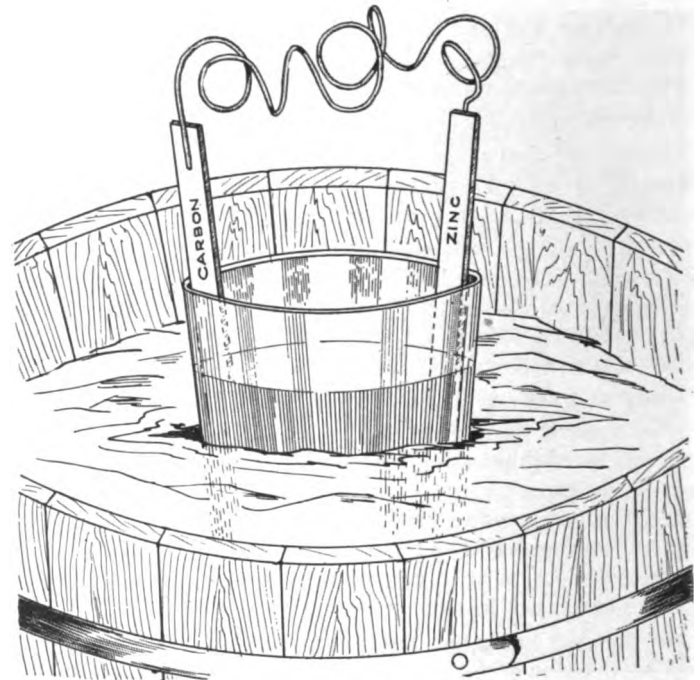

Figure II.

"Good evening, gentlemen." Then to Menutt: "Well, old scout, what's your latest grouch?"

"Say, Ashpit, you are a wonderful man if you have to listen all day to what I have for the last five minutes. I have been trying to learn how a magnet works, but I guess none of the bunch knows, and Professor Rush has been giving me gas to put me to sleep, I suppose."

The three highbrows smiled, in a tolerant manner, and looked expectedly at Mr. Ashpit to see how effectually he would pulverize the presumptuous Menutt.

"Well, of course, Menutt, we know certain laws governing magnetic action; if we didn't we would not be able to build ringers, receivers, retardation coils, and so forth; but if you want to know how a magnet is a magnet, I give it up—nobody knows that I know of."

"Well, well, well," said Menutt, grinning at the three crestfallen exponents of Physzselics. "Whad'ye know

about that? Nobody knows, eh? Hasn't anybody ever wondered but me?"

"Oh, sure," said Mr. Ashpit, "there have been a few people beside yourself looking into the matter during the past hundred years. There are many theories to explain it."

"Is that so? Well, what is the latest and best news on the subject?"

"Say, Menutt, before I start anything like that I must have a little refreshment. My throat always gets dry when I get to explaining things."

"Oh, that's why you have a Thermos flask on your desk all day, is it?" said Menutt. "Well, since I'm to get the benefit, this is on me. Let me sign that check, George."

George brought the lemonades, and grinned broadly when Mr. Ashpit called for a large pad of paper.

"Ah, allus knows when Mistah Ashpit calls foh a pad 'at it's g'wine t'be a long seshun."

"Go 'long there, George. Don't scare Menutt away. I'm going to tell him something I don't know myself. That oughtn't to take very long. Here goes, Menutt. I suppose you understand that we don't know any more about



Figure IV.

what electricity is than we do about magnets. That is, we know that the electric current will heat a wire red hot; and will give an awful bump when applied to the human body; but as to the exact 'how' and 'why' of it, why we are still guessing. We know, however, that something is going on in the space alongside of the wire, and if we bend a wire carrying current into a circle many curious things go on within this hoop.

"If you put enough of these hoops side by side and connect the beginning of one to the end of the next, thus forming a coil, you can, with enough current and a sufficient number of circles or turns, lift a ton of iron and hold it suspended in the air. That's the way we unload pig iron from the railroad cars out at Hawthorne. If you stepped inside of this coil, and every bone and muscle in your body became paralyzed, it would not be surprising, because it is easy to imagine that any power which would lift a ton of iron could readily put a human being out of

business—but—and here is the mysterious part of it—nothing happens at all. People have put their heads in the space between the poles of enormously powerful magnets and experienced no sensation whatever."

"Wouldn't that depend on whose head it was?" said Menutt. "I've always understood that ivory and bone were non-magnetic."

"Well, don't take any chances with your own, Menutt, because several kinds of gas have been discovered to be magnetic and you might meet a horrible fate."

"The question is—what is going on in this space which will hold almost any weight of iron and yet has no effect upon human sensations? We don't know, but we think that it may be similar circles in the iron. Many years ago it was noted that coils (which are nothing but a number of hoops placed side by side and connected together), carrying current, attracted each other, and the following experiment to demonstrate this has been tried by innumerable investigators."

Mr. Ashpit here drew a sketch (Fig. 1) on the pad, showing two batteries floating in a tub, the zinc and carbon of each connected by a coil.

"Now, no matter what position you put these little coils they will always float back into the same position with reference to each other; that is, they will always come together end to end, and the same ends will always be adjacent. If, however, you should bend the spiral around like this (Fig. 2) so that the various individual circles face in all directions, then no movement of the floating battery would occur. This shows that when the circles face in various directions they neutralize each other; whereas, when arranged in a straight and orderly manner, one in front of the other, their forces are added to each other.

"For many years scientific men have thought that if electric currents traveling around in circles were present in iron it would account for the peculiar magnetic properties of this metal, but the difficulty lay in explaining the source of any such currents and why they should travel in a circle. Now, however, that the existence of electrons in the atom is practically proven the problem becomes somewhat more imaginable."

"Hold on there, Ashpit," breathed Menutt faintly. "I have tried to keep up with you so far, but that 'electrons in the atom' has me beat. What does that mean—and how was it proven?"

"Well, well, I thought you read the News regularly—apparently you didn't see that alleged explanation of the repeater."

"Oh! You mean that story about the demons throwing marbles at the window blinds! Sure I read it. You mean to say, then, that the demons correspond to the atoms and the marbles are the electrons?"



Figure III.

"Exactly so, and if there were no such things as electrons, the telephone repeater wouldn't repeat.

"Now, if every substance is made up of billions of atoms, and every atom has a pocketful of marbles or small balls, your imagination can work up almost anything. For example, as we know that the electrons are moving within or around the atom, why not imagine the demons in the case of iron to be expert jugglers like this. (Fig. 3.) Whether electrons are electricity itself, or just balls of something else carrying charges of electricity, we don't know; but from the action of the repeater we think it must be one or the other; so you see, if there is a circle of revolving electrons in, or around, each atom like a juggler keeping six glass balls in the air, we have electricity traveling in circles, very small it is true, but still circles."

"Well, but—how can a ball of electricity be an electric current? Whoever saw a chunk of electricity, anyway?"

"Now, Menutt, I didn't say a chunk of electricity, I said the balls might be charged with electricity just like a condenser is charged. You can try it yourself. Tie a string around a subset condenser; charge it from the 110-volt direct current lighting circuit, and then swing it around a galvanometer or sensitive compass and see how the magnetic field created by this revolving charge of electricity will throw the compass needle one way or the other.

"Extremely sensitive measurements show that every substance is to some slight degree affected by the magnetic field, but iron, nickel, and cobalt are unique in their response to such stimulation, and one logical way of accounting for it would be to say that, while all demons could juggle some, the iron demons are some jugglers. That is, they can keep a much greater number of balls traveling in circles and at a much higher speed, than the demons in any other substance. Iron shows none of these properties, however, until placed under the influence of a magnetic field. In other words, the atoms are facing every which way and the various circles neutralize each other just the same as in Fig. 2. The general idea is illustrated thus (Fig. 4), the atoms are all busy juggling the balls, but their work is wasted for lack of direction; like the Editorial Board without Mr. Newlywed. When, however, the demons are subjected to an external magnetic force they all line up as a battalion of soldiers, like this (Fig. 5). You see here that you have the large coil carrying current and also the great number of atomic circles of current, and by the experiment of the little batteries in a tub of water you know that electricity traveling in a circle creates a condition within the circle known as a magnetic field, and that two such circles will attract each other; so the piece of iron represented by the regiment of demons is immediately drawn into the coil in the background of the picture. Have I answered your question?"

"I guess you have, Mr. Ashpit. I'm so dazed by the wonder of it all that I don't know whether you have or not. Why should the electrons on the iron atom revolve in circles when they don't in the case of brass or zinc?"

"Well, Menutt, all materials respond to some extent, and iron does not always respond; for example, if you heat a piece of iron up to 750 degrees the demons get hot and commence to throw their marbles instead of juggling them, and as a result the iron at this temperature becomes non-magnetic. Again, we don't know but what these little demons can be bred to juggle. A man by the name of Heusler prepared several different kinds of mixtures con-

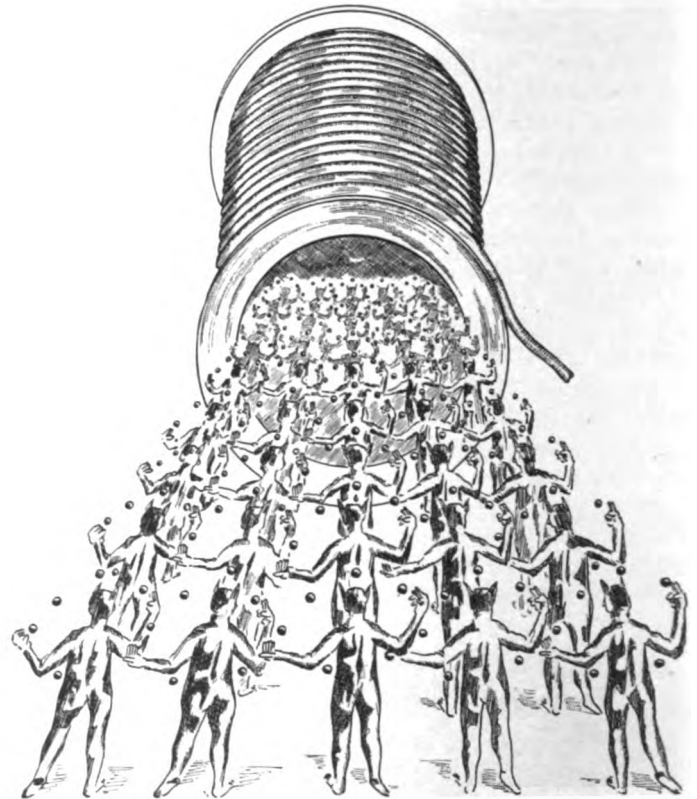

Figure 7.

taining no iron whatever, and yet magnetic far beyond anything heretofore known except iron.

"You see, Menutt, the difference between iron and other things isn't so radical after all: it is mostly a matter of degree, and we don't know enough to be sure that other substances cannot be made magnetic."

"It certainly is a wonderful subject, Mr. Ashpit. Does Professor Rush study that sort of stuff all day?"

"Well, maybe not all day, but his regular work involves the frequent consideration of such matter."

"Oh, one thing more. This magnet I have has no coil around it, yet it draws a piece of iron. How is that?"

"Well, you see, Menutt, that magnet is made of steel. Now when you mix carbon in certain proportions with iron you form a substance known as steel, which has certain properties quite different from iron. For example, the carbon seems to paralyze the demons from the waist down under certain treatment.

"If you heat a piece of steel red hot and plunge it in water it becomes hard, which is only another way of saying that you cannot push the atoms around mechanically. This same treatment holds the atoms in whatever position they may be placed.

"Your little horseshoe is a piece of steel hardened and then magnetized by a very powerful electromagnet like the one in the receiver assembly department. While this electromagnet can pull all the demons around into line as in Fig. 5, the demons themselves, on account of the hardened condition of the steel, have no power to break ranks."

"By Jove, that's immense. I want to apologize to you fellows, because I can see that a man doping out stuff like that all day gets a point of view which makes ordinary

everyday life look pretty small. It just goes to show how little we know about each other. Now, I'm sure if you highbrows would come down out of the ether more often you would get so you could appreciate a little josh once in a while. How about it?

"In the meantime, let's have a round of grapejuice and sing the doxology."

So the four highbrows and the Philistine all stood up and, holding their glasses high, they joined in song as follows:

*"Here's to the whole dang familie—
Engineer, sales and factoree.
Some of us like what others do not,
Even an accountant has a human spot.
Let them as wants, practice dignitee
If they take themselves so seriouslec;
But as for us, we're off that stuff—
Our creed is simple and for us enuff.
A little foolishness once in a while
Turns work into play and makes us smile,
And he who tackles his job with a grin
Is the happier man tho' maybe all in.
We all agree this is rotten verse,
But 'twas fun to write it—Good-night, Nurse."*



Our Installation Department Training Schools

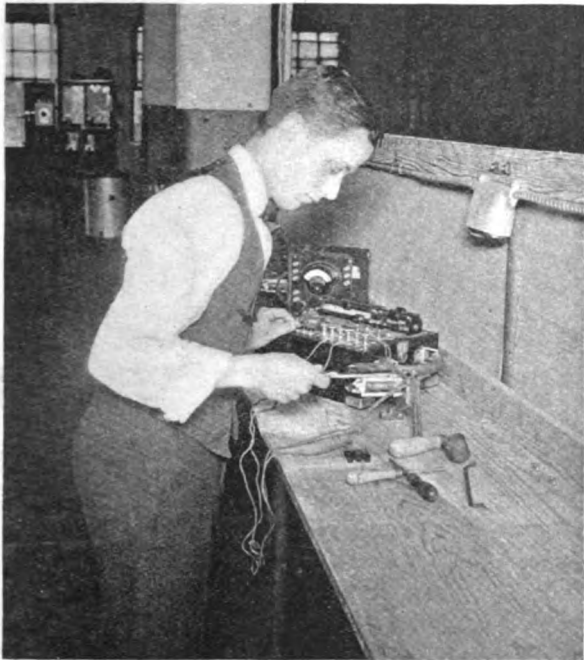

Student Receiving Instruction in Mechanical and Electrical Adjustment of Relays

IN REVIEWING the history of the Installation Department, several periods appear where, due to the rapid growth of the telephone field, and the many changes necessary in the central office equipment in order to maintain a modern plant, it became necessary to increase the installing forces at short notice, by the addition of new men who were inexperienced in our line.

At the beginning of 1916 it became evident that the department would be required to increase its number of employees within the year from some 1,200 to 2,200 men. Early in 1917 it was found that we had exceeded the 1916 estimate by a few hundred, and that we would require a steady increase during the entire year, which at the beginning of 1918 would give us some 3,700 men. The middle of July now finds us with over 3,500 employees, which are some 600 more than the department has ever been able to boast of.

To meet the demand for increasing the force to such an extent, it was determined that training schools located in the larger cities, central to each district, would solve the problem. These schools would permit a centralized point, where applicants could be interviewed, physical examinations arranged for, and, if hired, given a short course of training.

In June, 1916, the first training school was established in New York City. Remarkable results were obtained, considering the short time devoted to the training. We now have schools in operation in New York, Philadelphia, Pittsburgh, Cleveland, Chicago and St. Louis.

Up to quite recently the schools have been devoted exclusively to the teaching of new employees, the course



Student Learning to Trace Continuity of a Standard Circuit. These Boards Are Wired on the Back to Reproduce True and False Electrical Conditions at Various Test Points



Special Class of Circuit Course Instructors Receiving Preliminary Training in Telephone Theory and Practice

consisting of twelve days and consisting of the simplest and most common operations, such as sewing cables to cable racks, stripping, butting, waxing and forming cable ends, and the connecting of cable ends to terminal blocks. At the end of the course, the finished product of each student is required to pass inspection before the student is transferred to the field.

In the fourteen months of existence, the schools have accepted for training some 3,351 new men. Of this num-

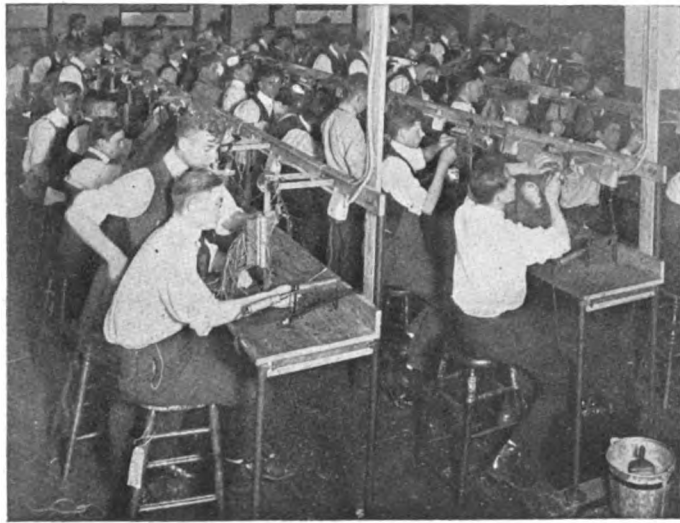

General View of Wiring School. Here Workmen Are Taught Fundamentals of Running, Forming and Connecting Switch-board Cable. 90 Men Can Be Trained at a Time

ber, 2,505, or 74%, have graduated, and have been distributed to various installations.

Within the past month a two-week course in telephone theory and circuit practice has been established in each of the schools. This course is given to employees who have been in the service one year or more, and will be of considerable benefit to installers in broadening their knowledge on the general action of electric current as applied in the modern telephone central offices.



Instructors Circuit Training Course. These Men Have Since Returned to Their Districts and Are Now Conducting Classes at New York, Philadelphia, Pittsburgh, Chicago and St. Louis

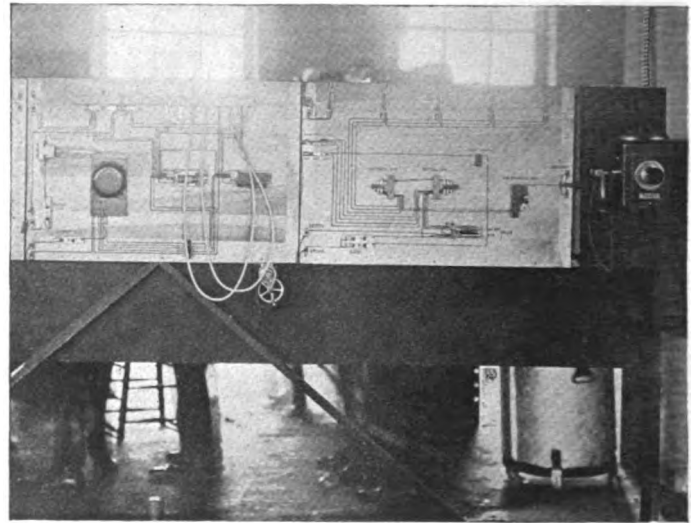

Chicago Training School-Circuit Course. A Physical Telephone Circuit Between Two Subscribers in the Same Exchange, Arranged to Visualize the Continuity of the Circuit in the Operation of the Various Pieces of Apparatus

Results of New Customers and New Business Contest for June, 1917

THE salesman securing the largest number of new customers during June was:

A. T. Slack, Denver

The salesmen securing the highest number of points or sales to new customers for the period ending June 30th were:

G. McCallum, Kansas City, 409 points.
A. B. Spicer, St. Louis, 379 points.
J. E. Lowery, Dallas, 319 points.

The Jovian Order Suspends Dues

The Jovian Order has decided to suspend all payment of dues for members who enter military service. The suspension will be enforced during the period of their enlistment.

Changes in Organization

SINCE August 1st J. V. Baker has been Stores Manager at Cincinnati. Mr. Baker is an old employee of the Company, who started in the old Clinton Street shipping department. In mounting the rounds of the ladder to his latest promotion he has served in Dallas, St. Louis and Hawthorne.

AROUND THE CIRCUIT

GOSSIP GATHERED BY THE DISTRIBUTING HOUSE CORRESPONDENTS

Boston

C. A. O'Dea, Correspondent

Julien Leon Lanctin, who has contributed this interesting article on trench warfare, is, as far as we know, the first Western Electric man to go through the severe tests of battle and return to the Company's employ.

Mr. Lanctin started with the Company in 1912 as a machinist and has returned to his old position in the Boston shops.



Mr. Lanctin is On the Right, With a Hand Set to His Ear. This is a First Line Trench

"When the war broke out in 1914 I was at that time subject to call by the Republic of France. This call I received September, 1914, and I immediately left the United



Mr. Lanctin in the Uniform of the Army of France



Mr. Lanctin and His Wife

States for service in the Army. I arrived in France the latter part of September, 1914, and, as I had had two years of training in the Army before leaving France the first time, I was immediately sent to the front without any time for additional training.

"My duty in the trenches was that of telephone operator, and I was assigned to a group of six men—this was the regular number to each group. Each one of us was equipped with a hand set (as shown in the picture) and about 200 yards of wire were attached to it. When the command to charge on the enemy's trenches was given, we would go in advance, at the same time laying the wire, also telephoning to the General Staff Headquarters as to the progress made by the regiment. The telephone system was so arranged that we were able to communicate with



A Pulsating Morning at the Boston Office. Those in the Picture Are (left to right): Miss I. M. Vacuum, Miss A. Imaginary Point, and Miss Anna Transparency; and Messrs. Fourth Dimension, Low Visibility, Thinair, Horizon, and the Honorable Vacuous Void, Who Was a Visitor at Our Boston Office That Day.—Ed.

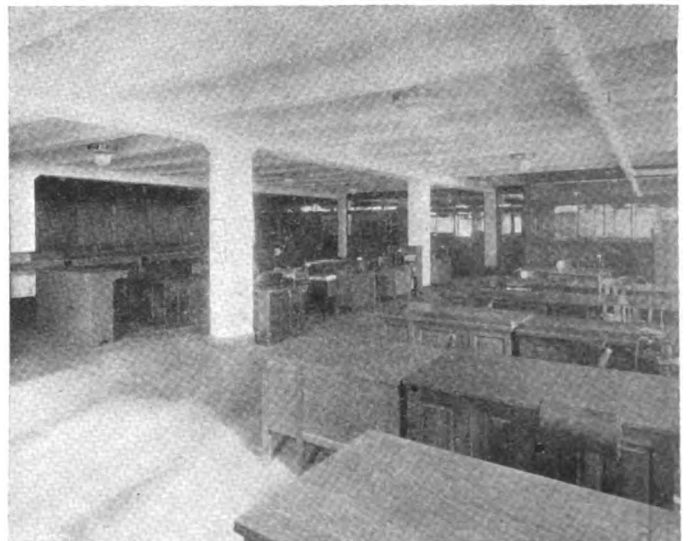

We Don't Doubt But That This View of the Boston Office Is a Dandy Ad for the Western Electric Vacuum Cleaner, But We Should Prefer to See a Quiver or Two of Animate Life in Photos Designed for the NEWS Columns.—Ed.

THE NEWS RECEIVES TWO PICTURES FROM THE BOSTON HOUSE

each other in our group as well as with the general staff, regiments and artilleries.

"My position was always a dangerous one and I knew that I could not escape serious injury—maybe death—but I had the good fortune to escape serious injury till the Battle of Vimy Ridge, when I was struck with shrapnel from a bursting shell. My injuries were so serious that I was in the hospital for six months.

"The most important battles which I took part in were La Basselle, the Somme, and Vimy Ridge.

"The telephone has played a most important part in the warfare of the trenches—without it many more soldiers would have been killed. The trenches are a network of telephone systems which enable the men to communicate with each other, and all parts of the trenches are given instant warning of advances of the enemy."

Mr. Douglas B. Baker, who left our employ in May to go to Plattsburg, has, we note, been assigned to a Second Lieutenantcy in the Army.

Chicago

W. M. Goodrich, Correspondent

IT ISN'T YOUR FIRM—IT'S YOU
If you want to work for the kind of a firm
Like the kind of a firm you'd like,
You needn't slip your clothes in a grip
And start on a long, long hike.
You'll only find what you left behind—
There's nothing that's really new.
It's a knock at yourself when you knock your firm,
It isn't your firm—it's you.

Real firms are not made of men afraid
Lest somebody else gets ahead.
When everyone works and nobody shirks,
You can raise a firm from the dead;
And if, while you make your personal stake,
Your neighbor can make one, too,
Your firm will be what you want to see—
It isn't your firm—it's you.

—G. M. W.



Do You Know This Guy? The Fellow Who Goes Charging Around Corners and Through Doorways With a Long, Sharp Pencil Sticking Out of His Mouth and Endangering Everyone He Meets. There Is One or More of His Type in Every Western Electric Office. Let's Hope That He'll Soon Find His Place Right out in One of the Front Line Trenches

NATIONAL ARMY DAY

Saturday, August 4, 1917, Chicago honored its new draft army with a monster parade. About thirty thousand drafted men were in line, led by the men in training at Fort Sheridan and local National Guard Regiments. Sousa's Great Lakes Naval Band furnished music at the



The National Army Parade

reviewing stand where the Russian Mission, with General Barry's staff, reviewed the parade. About twenty-five Western Electric men who have been called were marchers. It is estimated that more than a million people watched the parade from the sidewalks and windows of office buildings.

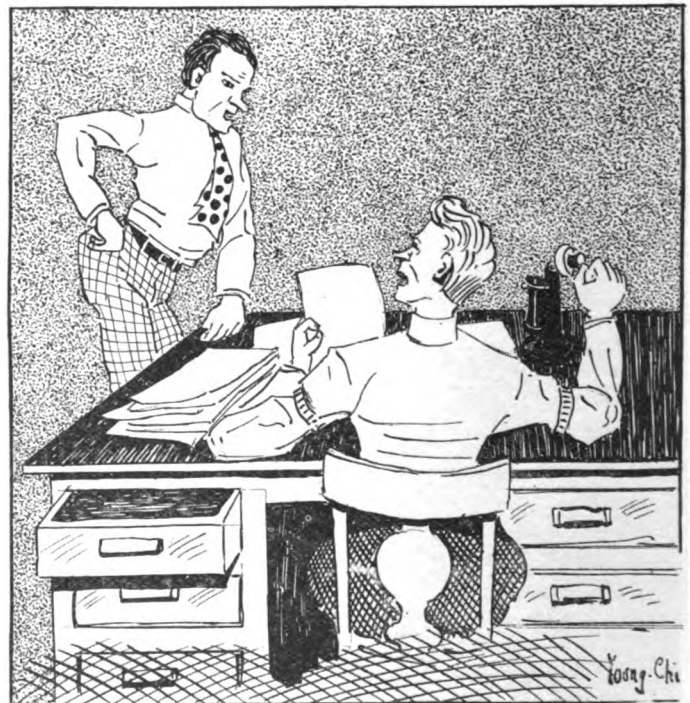

THE DRAFT IN CHICAGO

Prince Albert Caestecker, of the Sales Department, Whose Drawing Number was 10202—"Well, Old Pal! I'll Meet You in the Trenches About September 1, 1918"

Ferguson Fague, Head of Claims Division, Whose Drawing Number Was 501—"Yes, and by the Time You Get There I'll Be a Colonel and I'll Have You Serving Under Me"

Kansas City

A. D. Barber, Correspondent

On Friday evening, August 3, the office sales department, including our veteran manager, Mr. Uhrig, and our newly acquired sales manager, H. L. (Harry) Harper, entertained the road salesmen in a unique manner. The boys had been attending a two-day Farm Lighting Agents' Conference and were agreeable to a little recreation and food.



At the Round Table

Mr. Wells, as chairman of the entertainment committee, had arranged a well-decorated dining-room and attractive menu and had advised the office force regarding the program. After the Home Guards (or theorists, as Harry Hallett terms the office sales department) were seated, the road men were ushered in one at a time, introduced by our oratorical expert, Mr. C. L. Wells, and escorted to the round table. The table was set up exactly as shown on the Weekly Pep Bulletin, and the novelty of the situation proved a complete surprise to our knights of the grip.

After the men had become sufficiently impressed with their relative standing at the table, everyone was served a regular dinner and the party adjourned to the Assembly Room and the opening of our semi-annual local sales conference.

New York

D. Broadhurst, Correspondent

"OUR ENGINEERS MUST BE SERVED"

To provide still further space for the ever-expanding Engineering Department, the Stores Department of the New York Distributing House vacated additional space in the West Street Building, renting an additional block 95,000 square feet in the Terminal Warehouse Buildings at 28th Street, in order to equalize the space given up. The New York House is now operating from six separate locations within the city limits, whereas normally they would have but two.

ALL THIS FROM OUR EXPORT DEPARTMENT

Jose Felipe Antonio Mejia y Borja Alvarez Sagastegni y Coca, while on his vacation last month, turned his work over to his assistant, Manuel Simon Sirineo Moran y Mariscal de Calvo y Crivelli Marquez del Gasol.



E. E. Higgins in His One-Ton Truck

E. E. Higgins, the heavyweight of the New Haven Sales force, has a disappearing Ford. On the evening of August 11th the car wandered from where it was hitched and was not heard from for several days, when it was discovered that "Elizabeth" had been stripped and left shivering and Evelike in a vacant lot minus tires, tool kit and other appurtenances calculated to cover her up.

Cincinnati

D. E. Smith, Correspondent

Some two or three issues back, Dallas took occasion to speak harshly to the General Department for stealing its correspondence manual, complete and entire, and embodying it into a G. S. B. by the simple method of changing the title and assigning a number—Dallas got sore because it didn't get due credit.

Now with us it is altogether different. The General Department copies our plan of campaign on the "Farm Light Plant" sale, including our demonstrating outfit, and so on, from A to Izzard. Through a slight inadvertence, they neglect to tell anyone where the idea came from, however. Do we get sore? Do we holler? Nix, no—shame on you, Dallas.

It cost fifteen cents to telephone from Nashville to Mt. Juliet, Tenn. Mr. Hawkins, storekeeper at Nashville, had an occasion to telephone between the two places on our account. Result—Atlanta JB-52914, amount 15c. Possibly a street car ride would have saved us ten cents.

St. Louis

DEAR MR. EDITOR:—

Well, at last the boss has wished this correspondent job on me; but there are one or two conditions I would like to insist on.

1st. Just put "Wad" at the head of the St. Louis column.* *I prefer it.* My friends will know, and it will make others curious.

2nd. Tell your Assistant Editor *not* to ask for my picture.** I'm fat and bald-headed, but have feeling just the same as thin people, and am not looking for personal publicity.

Also please do not make any mention of the change in correspondents.***

* We shall. ** We have. *** We won't.—Ed.

WHAT'S IN A NAME?

With apologies to Jim Bateman, Bill Quirk, Harry Grant, Ralph Geeska, Ross Cummings and all other duly recognized Western Electric poets.

"Al" Perry is in charge of stores in old St. Louis town. Alphonso Lorenzo is his name. Ye Gods! just see him frown.

[Deleted by the Censor. Consult Wad or Perry for details.]

When West Meets East

Special Correspondence on Vice-President Swope's Japanese Visit, by Our New Tokyo Correspondent, D. F. G. Eliot



How the Guests Lined Up at Mr. Swope's Dinner in Tokyo. Mr. Swope Is the Fifth From the Left

ON June 6th Mr. Swope gave a dinner for the heads of departments of the Nippon Electric Company, our Japanese allied company, at the Maple Club, in Shiba Park, Tokyo. As a recognition of the long and pleasant association between the two companies, it was indeed a memorable event, and as a good, enthusiastic dinner, with lots of "pep" from start to finish, it will be hard to beat. Let us hope that this is a forerunner of many more such dinners in years to come.

The Maple Club is a spacious tea house, in the center of Shiba, one of Tokyo's most beautiful parks. Surrounded by gardens filled with trees and flowers, fish ponds and everything that is found in a natural setting, it was hard to believe that we were sitting down to dinner in a city of about 2,500,000 people, one of the world's largest cities. It seemed almost like a big party of congenial guests on a week-end house party in the country.

Just as you do in New York or Chicago, we gathered in

the reception room, where we spent a pleasant half hour, and then the "shoji" were thrown open, and we took our places. It was rumored that certain Americans present were afraid they wouldn't be able to find their places from the place cards, but Mr. Swope, realizing this deficiency, had thoughtfully provided English cards as well as Japanese, so all went well.

The dinner was started by short addresses by Mr. Swope and Mr. Iwadare, Managing Directors, outlining briefly the joint history of the Nippon Electric Co., Ltd., and the Western Electric Co. during their eighteen years of association in Japan.

These addresses were concluded far too soon, but we had more serious business before us, so, in spite of Mr. Spiller's repeated requests that he be permitted to speak, too, we proceeded with our dinner. The accompanying photograph will show better than any description our seating arrangements—the only missing detail being the crossed flags of Japan and America over the doorway directly back of the camera. Everything was done in the best of Japanese style, except the talking, which was mostly in English; although certain ambitious Americans, in spite of a natural feeling of embarrassment, did attempt to converse in limited Japanese. Between courses we were treated to some very pretty and interesting "Maple Club" Geisha dances, and these, with informal geisha dancing and music interspersed, made it indeed a gala evening. Nor did we lack for color, which was ever present in the gay, bright-hued kimonos of the geisha.

As a fitting end to a very pleasant evening and a splendid dinner, many "banzais" were given and responded to with enthusiasm, after which we betook ourselves homeward, independent of gasoline or horse-power—for our vehicle is neither taxi nor hack, but the rickshaw, the man-pulled cart of Japan.



A Group of Geisha Girls

Facsimile signatures of:
 K. Iwadare
 K. Fujii
 Y. Masujima
 T. Mayeda

On Tuesday, June 26, 1917, ten of the principal shareholders of the Nippon Electric Co., Ltd., attended an informal luncheon given by Mr. Swope at the Imperial Hotel. Brief talks were given on the cordial relations between the Nippon Electric Company, Ltd., and the Western Electric Co.

This luncheon was of exceptional interest due to the presence of the five original shareholders of the Nippon Electric Co., Ltd., who founded the business in 1899, Messrs. K. Iwadare, K. Fujii, Y. Masujima and T. Mayeda. The signatures of these five are given here in facsimile.

On Friday, June 29th, at the Imperial Hotel, Tokyo, Mr. Swope gave a dinner in honor of His Excellency, Baron K. Den, Minister of the Japanese Government Department of Communications. Among the twenty-five guests were many department heads of the Bureau of Communications, Mr. A. W. Burchard, vice-pres., and Mr. M. A. Oudin, foreign sales manager, of the General Electric Co., Mr. M. Fujise, managing director of the Mitsui Bussan Kaisha, and representatives from the Nippon Electric Co. and Western Electric Co. A few appropriate remarks were made by Mr. Swope and Baron

Mr. C. Asayama	Chief engineer, the Eastern District Post Office.	1
Dr. O. Asano	Professor of Electrical Engineering, Tokyo University.	2
Mr. A. W. Burchard	Vice-President of General Electric Company.	3
His Excellency Baron K. Den	Minister of The Department of Communications.	4
Mr. D. Eliot	Director of Nippon Electric Company.	5
Mr. M. Fujise	Managing Director of Mitsui Bussan Kaisha.	6
Mr. J. R. Geary	Representative in Japan—General Electric Co.	7
Mr. E. Hata	Sales Manager of Nippon Electric Company.	8
Mr. T. Hida	Engineer in Charge of Second Division, The Electrical Laboratory.	9
Dr. H. Igarashi	Formerly Engineer in Chief of the Eastern District Post Office.	10
Mr. K. Iwadare	Managing Director of Nippon Electric Co.	11
Mr. S. Kageyama	Secretary in Chief, the Department of Communications.	12
Dr. S. Kondo	Director of Engineering Division, The Electrical Bureau.	14
Mr. G. Matsumoto	Secretary, The Department of Communications.	15
Mr. M. Matsushiro	Osaka house Manager, Nippon Electric Co.	16
Mr. K. Munessaye	Director General of the Electrical Bureau.	17
Mr. K. Nakagawa	Director General of the Post, Telephone, and Telegraph.	18
Mr. I. Nakayama	Chief Engineer, Nippon Electric Company.	19
Dr. S. Oi	Formerly Chief Engineer, The Bureau of Post, Telephone and Telegraph.	20
Mr. M. A. Oudin	Foreign Sales Manager, General Electric Co.	21
Mr. S. M. Spiller	Far Eastern Manager, Western Electric Co.	22
Mr. Gerard Swope	Vice-President, Western Electric Company.	23
Dr. U. Torikata	Engineer in Charge of Fourth Division, The Electrical Laboratory.	24
Dr. M. Tonogawa	Director of the Electrical Laboratory.	25
His Excellency K. Uchida	Vice-Minister of The Department of Communications.	26
Mr. S. Urata	Chief Engineer, The Bureau of Post, Telephone and Telegraph.	27
Mr. R. Wakameda	Engineer, ditto.	28
Mr. S. Watanabe	Director of The Foreign Traffic, The Bureau of Post, Telephone and Telegraph.	29

In English—Those Present

Den at the close of the dinner. The Japanese-American menu lent itself very well to the customs of the guests of both nationalities. It opened in the Japanese way, that is, from the back. As we see it, one has the Japanese menu, whereas the American may open it from the front to find his menu. So we can both feel suitably honored by having the menu arranged so that our own language comes first.



Mr. Swope in His Rickshaw

A Dinner at Osaka

On July 6th Mr. Swope gave another dinner—this time to some of the older employees of the Osaka house.

The following were present, and their service record with the company is quoted:

K. Iwadare	20 years
M. Matsushiro	12 "
M. Hosono	20 "
T. Ikawa	11 "
S. Tanaka	11 "
Z. Kuriyama	10 "
K. Fukaya	9 "
M. Awata	9 "

Vertical Japanese text listing names and service records of attendees at the Osaka dinner.

In Japanese—Those Present

The Nippon Electric Company Picnic

By S. Hirata

Head of Tool Service and Maintenance Dept.

ON April 15th the employees of the Nippon Electric Co., with their families and friends, gathered under the cherry blossoms at Yebisu Park, just outside the city of Tokyo, to celebrate the annual picnic and garden party. If the weather had been fine eight hundred of our employees, with about twelve hundred of their families and friends, would have attended; but, to our great disappointment, the morning was cold and rainy, and many stayed at home. In spite of the bad weather, however, the program was carried out completely.

The track meet, which is always an important feature of the Garden Party, furnishing both excitement and amusement, started at 9 o'clock and did not end until 2 in the afternoon. Many of the events were closely contested, and all were much enjoyed both by contestants and guests.

By far the most extraordinary race of all was the guest race. In this Mr. K. Iwadare, our managing director, stood on the mark with Messrs. Hata, Spiller, Eliot and a dozen or so others, each carrying in his hand a ball in the bowl of a wooden spoon. I myself have known Mr. Iwadare for twenty-five years, and my father has known him for half a century, but we have never heard of his running a race, nor seen him on the race track. It was surely an unusual occurrence.

In any event, "ZDON" went the gun, this being the way a gun sounds to Japanese ears, and off they started (as a matter of fact the "gun" used on this occasion was a shot gun, as no one had a pistol. Pistols, as well as "hold-ups,"

are very scare out here). Half a dozen boys dropped the ball as soon as they started, and the others followed suit, one by one, as they ran around the track. Holding the ball is not easy.

Only five or six reached the finish line. First, young Master Hata, son of our sales manager and shop superintendent; second, Mr. D. Eliot, "our newly imported American." This gentleman had legs nearly a foot longer than his opponent, and nearly won, but the younger runner passed him on the home stretch.

At this moment Mr. Iwadare was nearly a quarter of the track behind. See how he runs; no, walks, and much slower than one walks to "base on balls." This was a true reflection of his character—slow but steady, always making sure to succeed. At last he stepped, smiling, over the finish line, with ball and spoon both quite safe. I thought he had taught us a lesson; that, in our haste to succeed, we should be careful not to "drop the ball."

There were many other amusements arranged. Two stages were erected for dramatic performances, one being used by professionals, and the other by employees and those of their friends who possess dramatic talent. The plays were enjoyed especially by our friends of the fair sex, and the audience remained until driven away by a heavy rain.

It is unfortunate that the bad weather kept so many away, and prevented our "Kodakists" from carrying away some pictures with which to illustrate this article.



M. Shannohoffski Sends the NEWS This Picture of Installers on the Gloucester, Mass., Job. Who Subscribed \$1,000 to the Liberty Loan After a Rapid-Fire Canvass by Foreman C. L. Priest

Western Electric News

PUBLISHED
MONTHLY

FOR THE
EMPLOYEES

BY THE WESTERN ELECTRIC COMPANY, INCORPORATED

H. B. Thayer, <i>President</i>	H. A. Halligan, <i>Vice-President</i>
W. P. Sidley, <i>Vice-President</i> and <i>General Counsel</i>	A. L. Salt, <i>Vice-President</i> and <i>Gen. Purchasing Agt.</i>
Gerard Swope, <i>Vice-President</i> and <i>General Sales Manager</i>	H. F. Albright, <i>Vice-President</i> and <i>Gen'l Superintendent</i>
J. W. Johnston, <i>Treasurer</i>	F. B. Jewett, <i>Chief Engineer</i>
G. C. Pratt, <i>Secretary</i>	B. H. Gregory, <i>Comptroller</i>

C. E. Scribner, *Consulting Engineer*

Office of publication and address of President, Secretary, and Treasurer, 195 Broadway, New York City.

BOARD OF EDITORS

P. L. Thomson, <i>Editor-in-Chief</i>		
P. K. Condict	E. C. Estep	S. W. Murkland
W. F. Hendry	F. J. Holdsworth	H. D. Agnew
John Colter		Reed Calvin

Subscription: \$1.50 per year, except to employees of the Western Electric Company, to whom copies are furnished free of charge.

All communications and contributions should be addressed to WESTERN ELECTRIC NEWS, 195 BROADWAY, NEW YORK.

Matter intended for any given issue must reach New York not later than the 12th of the preceding month.

Mr. Vail Bids the Monmouth Boys Good-Bye

Telephone Officials Visit the Signal Corps Reserve Camp in New Jersey



THE telephone men composing the First and Second Battalions of the Signal Corps, U. S. R., at Monmouth Park, N. J.—the place where our Eastern Radio Company officers are in training—received a memorable visit recently from President Vail and a party of telephone officials who came to extend to the corps wishes for good luck and Godspeed. With President Vail were Senior Vice-President U. N. Bethell, Vice-President N. C. Kingsbury, General Counsel N. T. Guernsey, and Chief Engineer Major J. J. Carty, of the American Telephone and Telegraph Company.

Lieut. Colonel Hartmann, camp commander at Monmouth Park, received the guests and conducted them about the camp. From the tour of inspection of the camp the guests were escorted to the parade ground, where they formally reviewed the two battalions. After the men had displayed the military training acquired in the short time that has elapsed since they had stepped out of their civilian clothes into the olive drab of the army, they were formed in a hollow square surrounding the reviewing party. Col. Hartmann then introduced President Vail.

As Mr. Vail stepped forward facing the colors, his arm came up smartly to salute and he removed his hat. He spoke with visible emotion, and evidently felt strongly the deep significance of the occasion, and that it was to be the last word that he would have for the men before they left to take up the important work on foreign soil for which they have been training.

"Boys, I have come down to say good-bye before you go. You have transferred to your and our country the allegiance, intelligence, and faithfulness you have shown to our company and your company, and in so far as you put these into your service for your country and our country, you will earn all the commendation any one can give you. You must all do your best—not comparative, good, better, best, but your very best. It is not comparative; it is relative, and relative to each of you, and you must make it relative to your opportunities, your abilities, your training and everything else.

"I wish you all success, and hope to meet you again in no distant future, and wish you all the good things that are coming and a safe return."

Mr. Bethell spoke next, addressing the men as of the Eastern Group and wishing them success and Godspeed.

Major Carty was then introduced by Col. Hartmann, as "Senior Signal Reserve Officer of the United States." Major Carty said:

"Never before has more been expected of men than is expected of you. The fame of the Bell System extends throughout the world. General Pershing's signal officer recently wrote a letter in which he said that the French Signal Corps await with intense interest the arrival of our battalions to show them the wonderful developments of American telephony. I am confident that you will uphold the best traditions of the Bell System and the best traditions of your country. You are brave and capable men, and you will give a good account of yourselves."



Major Carty, Mr. Guernsey, Mr. Kingsbury, Mr. U. N. Bethell, and Mr. Vail (from left to right in the order named) Greeting the Camp's Majors at Monmouth, N. J., Recently

AMONG THE ENGINEERS



NEWS OF THE DEPARTMENT FROM NEW YORK AND HAWTHORNE

New York
K. Bungerz, Correspondent

BRITISH WAR MISSION

OFFICE OF THE CHAIRMAN
LORD NORTHCLEFFE

321 Fifth Avenue,
New York City, N.Y.

My Dear Mr. Jewett,

Many thanks for the oscillograms which I am sending to England, with the exception of those of Mr. Robert Borden, which I am sending to him through my military aide-de-camp, Lieut. Colonel Campbell Stuart who knows him.

I cannot tell you how much we talk of the romantic day we spent with you. I have exhausted most of the experiences of life. I have travelled in submarines, tanks, flying machines, have seen the biggest battles of the war, Niagara, Suffern (India), and the Grand Canyon of the Colorado, but nothing stands out more vividly in my memory than that dramatic roll call of the American cities.

Yours sincerely,

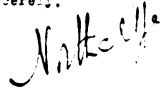

P. B. Jewett Esq.,

10th August, 1917.

How Lord Northcliffe Liked His Visit to 195 Broadway and 463 West Street

Private William F. Hessler, who was formerly in the General Merchandise Department at West Street and at present with the British Expeditionary Force, General Hospital No. 1, France, has written a letter to his friend, A. Q. Smith, of the Engineering Department, which we quote in part:

"Your letter of the 19th, which was received to-day, the 10th of July, was very interesting, and it is the first letter received in which there was any news. News on this side is very scarce. Very glad to see that you are with a good company. Do me a favor, Huh? Send me the WESTERN ELECTRIC NEWS each month. Much obliged. Also, you might go down to the G. M. Department and give Culliney my regards.

"The Red Cross has been pretty good to us in looking after our comfort. My R. C. number is A 587 and my Regimental number is 60. Am doing a month of night duty in the hospital and am snatching a spare moment to scribble these lines. France and England are some coun-



W. F. Hessler

tries. . . . Discipline is the keynote of the British Army. It is a great life; nothing to do but work 85 hours a week. You should see me in uniform with my Donald Brian mustache.

"There is an English officer in the hospital who has 57 wounds in him.

"(Signed) WILLIAM F. HESSLER."

Honble Sir, Mr. Editor,

WESTERN ELECTRIC NEWS JOURNAL,

In Building with Honble P. K. Condit who have resided in Japan sometimely.

DEAR SIR:

I have occasion to toil for livelihood in building on street opposite Jersey which are property of firm of Hendry & Morrison, dealers in Towels, Steam Heat, Elevator Service and Hot Air (for ventilating systems). Owing to nature of my work and of building, it is required of me that I shall frequently at numerous intervals in course of day's labor descend and ascend up and down stairs. It is, of course, obviously plain that elevators are provided for climbing and descending stairs which are either crowded, guarded by persons in honble uniform which do not fit around neck and do not match shoes, or are bordered by signs, "Wet," which do not indicate condition of recent washing, but rather condition of office boys' finger-marks covered by paint of color of Teuton chance of victory.

Now, Mr. Editor, I submit for your approval that stairs are no place for going from basement section H to Honble Harris emporium on 13-A. Yet thus are conditions. Much has been written about elevator service A and B. Much of this writing are schedule time table of periods at which little lights in car can be contemptuously ignored by liveried aviators who volplanely descend except that they have rapid climbing machines which can fall in straight lines without executing involute winding system of sliding on atmosphere.

But these are not all. Honble Hendry have expressed opinion that schedule are schedule, and that individual wishes of engineer are nothing at all. In addition, he have adhered tenaciously with bearlike grip to old custom instituted by ancient usage which demand that vests have sleeves if person wishes to ride on machines A and B. In other words, Honble Sir, shirt sleeves are all right when they are, but not so when on elevator. Since honble female lady employees wear waists, the rule do not apply in their case.

Honble Sir, you are much acquainted with Hendry member of aforementioned concern. You permit him voice in councils of what shall be wrote in News. Can you not, sir, impress on Honble Hendry need of air on part of man which are allowed woman?

I await, sir, your favorable reply which depend, of course, on attitude of powers that be, which is to say Honble Sho Guns that preside over destiny of Western Electric.

Again, sir, I await.

Yours truly,

TASHIMURA HOGO.

At the Board of Editors' meeting, which was held on one of those sweltering days that marked the exit of July, Bill was compelled to sit through the session with his coat on, with the result that the order to swelter on the West Street elevators was promptly rescinded.—Ed.

Hawthorne

W. E. Viol, Correspondent

HAWTHORNE ENGINEERING DEPARTMENT'S SIXTEENTH ANNUAL PICNIC

"From noon 'til night,
With main and might,
We'll all go picnicking to-day."

This theme from the "Picnic Poem" by our departmental bard, A. Thomas, tells the story of July 21—the Sixteenth Annual Picnic of the Hawthorne Engineering Departments.

"Ho-hum," you say. "Some more of that doggoned picnic stuff. Same old bunk about the grandest time ever, and so forth, and so forth, and so—ho-hum—tiresome." Well, you're wrong. Like the automobile advertisers, we're run out of superlatives, so (unlike lots of them) we're going to stick to unvarnished facts and try to keep our enthusiasm chained down.

One hundred and eighty-five engineers and draftsmen hied themselves to Hammond Beach, Ind., and proceeded to picnic "with main and might." Some, enticed by a crowd of mermaids on the beach, immediately took to the water. The others started a baseball game, which the "Old-Timers" won with ridiculous ease from the "Youngsters."

In the field events B. J. Alexander won the fifty-yard dash, the sack race and the backwards run, "they say," because he had spikes in his shoes. T. C. Rice and T. H. Forster, with the advantage of sitting together at work, had no difficulty in annexing the three-legged race. Finis, Stalknecht, Fajarajzl, Behonnek and Flicek furnished the ten legs that won the centipede race. The bosses thought this race looked like an easy win, and J. Danner, H. W.



Left to Right—J. Danner, G. A. Anderegg, H. W. Mowry and J. H. Roth—"Fanning" at the Engineers' Baseball Game. Roth Appears to Have a Bet on the Losers

Mowry, C. M. Smith, G. A. Anderegg and J. Harper tried to get together, but you know how bosses are. Anyway, somebody skidded at the turn and, after kicking one another's shins, they landed a bad last.

A number of interesting sparring events lacked materialization when Art. Shelstrom failed to convince the Hammond chief of police that it was only to be a real ladylike affair. C. M. Smith won the quoit tournament.

The swimming events gave the water-dogs of the department a chance to have their fun. In the plunge, H. F.



At the Sixteenth Annual Outing. Hawthorne Engineers Outside the Inn Side

Blecka won. He also beat the field in the fifty-yard race. C. Olsen tried to put A. C. Rayspis under the water in the ducking contest, but the affair proved a tie. In the tub race there must have been a submarine nearby, as they all sunk. F. Blecka (he's some swimmer) also won the twenty-five-yard back-stroke race.

The end of the afternoon found everyone well able to do justice to the delicious and bounteous "shore dinner." The entertainment after the dinner was enthusiastically



Standing Up for His Side and Ready to Swing for It. "Youngsters" vs. "Old Timers" at the Hawthorne Engineers' Outing

received. The master of ceremonies was "Jolly Jock" Harper, our chief draftsman, who surely knows how to draw out talent. Among these were: J. E. Peterson, F. L. Zimmerman, J. L. Harrington, O. A. Stupe, A. J. Rakos and F. A. Schalk. A grand lottery of prizes closed the evening and everyone left with the feeling of having enjoyed the best picnic that ever was held—and we don't care if we *did* promise you to keep away from superlatives.

ROLL OF HONOR

CURRENT AWARDS OF OUR SERVICE BADGES

To be Awarded in September

THIRTY-FIVE YEARS				
Wildbore, J. E., Hawthorne, 6336.....	Sept.	—	McEwen, R. E., Hawthorne, 30.....	" 17
Simon, L. J., Hawthorne, 6346.....	"	20	Weith, L., Hawthorne, 6337.....	" 19
TWENTY-FIVE YEARS				
Just, F., Hawthorne, 6345.....	Sept.	—	DeLaroy, P., Hawthorne, 5771.....	" 22
Scully, W., Hawthorne, 6338.....	"	—	Smith, C. M., Hawthorne, 6961.....	" 22
TWENTY YEARS				
Baumruck, E., Hawthorne, 6377.....	Sept.	14	Courtright, H., Hawthorne, 6301.....	" 25
Hellweg, J. H., Hawthorne, 5900.....	"	15	Miller, F. H., Hawthorne, 6372.....	" 26
Palmer, A. Z., Hawthorne, 5376.....	"	20	Anisansel, H., New York.....	" 2
Rentzmann, A., Hawthorne, 6345.....	"	22	Sheridan, Catherine, New York.....	" 16
Lowe, F. H., Hawthorne, 6339.....	"	18	Franke, E. G., St. Louis.....	" 8
Schnitzer, J., New York.....	"	18	TEN YEARS	
FIFTEEN YEARS				
Jansen, L. W., Chicago.....	Sept.	3	Zelnicka, R., Chicago.....	Sept. 10
Hogan, P. J., Chicago.....	"	24	Petrovich, M., Hawthorne, 8198.....	" 5
Anderson, D. J., Hawthorne, 5064.....	"	4	Southon, A. T., Hawthorne, 5771.....	" 6
Bolin, C. A., Hawthorne, 5966.....	"	5	Franke, T. M., Hawthorne, 7383.....	" 12
Reed, J., Hawthorne, 5349.....	"	5	Jozwiak, J., Hawthorne, 6166.....	" 19
Tockstein, A., Hawthorne, 6300.....	"	5	Orloff, M., Hawthorne, 6321.....	" 22
Johnson, J., Hawthorne, 6321.....	"	6	Zimney, J., Hawthorne, 5351.....	" 23
Hoehn, H., Hawthorne, 6372.....	"	8	Cada, F. J., Hawthorne, 5756.....	" 24
Evans, C., Hawthorne, 6325.....	"	9	Kollech, G. D., Hawthorne, 6132.....	" 29
Reincke, G., Hawthorne, 6324.....	"	16	Bassett, G. O., New York.....	" 2
Kuehn, E. A., Hawthorne, 6442.....	"	17	Colpitts, E. H., New York.....	" 2
			Shreeve, H. E., New York.....	" 2
			Van Dorn, P. L., Omaha.....	" 25
			Bouligny, R. H., Richmond.....	" 9
			LeStrange, Bernice, San Francisco.....	" 13

Who They Are

J. E. Wildbore



J. E. Wildbore

The New York Shops acquired a trimly-built, athletic young screw machine operator in 1882. Wildbore was his name, but nobody ever accused him of living up to it. In fact, he was the very opposite of his surly, pugnacious namesake of the forests. That statement is made with all the assurance of

conviction, for Joe has been with the Company for thirty-five years, and if he had had any mean streak in him somebody surely would have located it before now.

So much for the name and the disposition.

Mr. Wildbore worked up from operator to section head, from section head to assistant foreman, and from assistant foreman to foreman of the screw machine departments, broadening with each job. And when we say broadening we mean it not only figuratively but literally. In fact, Joe's shadow has several times in recent years been mistaken for a total eclipse of the sun. However, that was when he first was transferred to Hawthorne in 1913. We've got used to him now.

Besides taking on flesh, Mr. Wildbore's principal amusements are boating, fishing, swimming and wrecking barbed wire fences with his automobile. Hold on, though; that last is a secret. But, anyway, Joe will have five stars on his service button after this month, so he won't need to hit any more fences, even if he wants to see a few, which he probably does not.

L. J. Simon



L. J. Simon

L. J. SIMON began collecting stars for his Western Electric service button in the old Kinsey Street Shop, where his first job was assembling telephone parts. Later he was put at power apparatus work, building theater switchboards, arc lights, rheostats, etc. About the time he would have received his first service button, if there had been any in those days, he was made an assistant foreman, and in 1907 he became a full-fledged foreman at Hawthorne, where he had been transferred some time before when most of the Chicago manufacturing departments were moved. He is now in charge of Partial Assembly Department, 6346.

F. Just



F. Just

Since a good inspector should be both frank and just it follows logically that Frank Just should be a good inspector. That was perhaps the reason he was given his present position of department inspector of finishes in the japping department.

Mr. Just started with the Company at New York in 1892, assembling telegraph relays and sounders. Later he became a milling machine operator, and after that a rubber polisher. He was then made an inspector. In 1914 he was transferred to Hawthorne, where he has worked in the metal finishing departments ever since.

Frank used to sing tenor in a shop quartet back in New York, but he has reformed since coming West, although occasionally as club representative he sings the praises of the Hawthorne Club.

1892 from 1917 will prove to you that Mr. Just is entitled to a twenty-five-year service button, which he gets this month.

A. Rentzmann

Probably few people who admire the beautiful finish on Western Electric switchboards realize the amount of care and skill necessary to produce that finish. Polishing and preparing wood for high-grade finishes has been Axel Rentzmann's work during most of the twenty years he has been with the Company. He started at Clinton Street in the wood-finishing department and worked continuously in the wood-working departments until 1913, when he was transferred to the japanning department, his present location.

Mr. Rentzmann is an expert tree trimmer and does considerable of that work during his spare time.

J. H. Hellweg



J. H. Hellweg

Since, book-keepily speaking, Hawthorne sells all of its output to the General Merchandise Department, J. H. Hellweg, merchandise manager, ought to stand high in the good graces of everyone at Hawthorne because he is the shops' best and only customer. However, it is doubtful if John's friends ever think of that claim on their affections. They like him just because he's John.

Mr. Hellweg began to make Western Electric friends twenty years ago, when he started to work in the factory cabling department at Clinton Street. From that job he went "on the road" as an installer, and later was made a foreman. He next entered the output department. Then he went into the sales organization and finally was made general merchandise manager, his present position.

John is noted for his great and uncanny affection for work and his unfailing good temper. Hereafter if he runs out of something to do, he can spend his time shining the new star on his service button.

A. Z. Palmer



A. Z. Palmer

A. Z. Palmer started to work for the Company in the shipping department at Clinton Street under Jack McDonnell, who is now wearing the only six-star service button at Hawthorne, so "Bert" is inclined to be skeptical as to his ability ever to gather in stars enough to catch up to his first foreman.

However, Mr. Palmer gets his second one this month, and that at least is a fairly good start.

From the shipping department Mr. Palmer went into shop store department, 2021, and he has continued in storeroom work ever since. His present position is chief of the storeroom of the repair department, 5376.

E. R. Baumruck



Emil R. Baumruck

Away back in '94 Emil Baumruck knew the company he wanted to work for, but he did not know the State factory laws. However, not letting a little thing like that trouble him, he calmly went after a job in the screw machine department of the old Clinton Street Shops. He got his job, too. Then somebody in the clerical organization found out that Emil was under legal age. And he got Emil. However, that is only Chapter I. The rest of the story tells how Baumruck came back for more in 1897, after outgrowing the State's objections, and how he has been with the Western ever since.

During the twenty years that have sped by since '97 Mr. Baumruck has worked in the subset assembly department, screw machine department, protector assembly department, japanning department and storeroom department. He is now in charge of shipping for Jobbing Department, 6377, at Hawthorne.

F. H. Lowe



F. H. Lowe

Did you ever hear a song called *Mike*? If not, you don't know F. H. Lowe, so we'll proceed to make you acquainted. Frank started in the New York Shops as a storekeeper in 1897, graduated into the punch press department, was transferred to the punch press department at Hawthorne in 1909 and is still there. Mr. Lowe is now a section head on the night shift.

Oh, the song? Why, you see Frank is a bit of a singer, and whenever the boys get together they get him to sing, and whenever they get him to sing he sings *Mike*. Of course, *Mike*, which is a good, strong, two-fisted Irish name, always makes a hit.

But one time when Frank can star without *Mike* is when he gets the third asterisk on his service button this month.

J. Schnitzer



John Schnitzer

On September 18th J. Schnitzer celebrates his twentieth year with the Company, and his entire term of service has been one of brilliant accomplishment, as "Old Jerry" during all this time has been a polisher and buffer at West Street.

The mechanical phases of his work he has, of course, well mastered, but those who have come in contact with him for years know that as a buffer, polisher and brightener of his surroundings that he does not restrict himself to the materials with which he labors, for his cheery and brightly polished disposition radiates in every corner of Department 411. To put a high polish on work, of course, requires skill and experience, but to be able to extend the craftsmanship to brightening and polishing up the minds of others is the complete fulfillment of the polisher's job, and "Old Jerry" has both phases of the work up to 100% efficiency.



Wm. J. Scully
Three-Star Man



E. A. Kuehn
One-Star Man



H. Anisansel
One-Star Man



C. A. Bolin
One-Star Man



W. Jansen
One-Star Man



P. J. Hogan
One-Star Man



C. M. Smith
One-Star Man



G. Reincke
One-Star Man

Traveling Through St. Paul in a Tunnel

By E. C. Estep

WHEN your conscience begins to bite you because you haven't contributed anything to the NEWS for a long time, and you try to think of something clever, just give it up and write a travelogue. There are two reasons why this is a good hunch: First, it's easy; it requires no originality to tell about something you have seen, and no effort to tie up something you have seen to the W. E. Co. Second, you are sure it will be accepted because all of the editors have accepted and printed their own travelogues, so they don't dare turn yours down.

In my younger days I read somewhere about the imprudence of building a house on the sand. I don't remember the story except that all of the best architects of that day agreed that it was a rotten place to build a house. It occurred to me, as I rode along the opposite* bank of the river, on my way into St. Paul, that the people of that city wouldn't have suffered any, even if they had never read that sand article.

You know they say New York City is built on a rock—maybe it is, for all I know, but you have to take some other fellow's word for it, and other people are usually wrong, but for straight out-and-out visibility, the rock that St. Paul is built on has all the other well-known rocks, such as those of Gibraltar, Ages, and the Road to Dublin, backed off the map. You can stand across the river and see the rock and see St. Paul on the rock, which is better than taking a subway contractor's word for it.

Every little way there is a hole in the side of the rock, from which emerge cables that run down the side like snakes. Harry Goodell explained that instead of putting in clay or wood conduits as is customary, the telephone and electric light companies run a tunnel through the solid rock and carry their cables along the sides.

We hunted up Wire Chief Julius Elinbacker of the main exchange and started a personally-conducted tour through the rock. We went down stone stairs and through a lot of iron doors that, as we got further into the rock, clanged ominously after us. I had been wonder-

* Whaddyemean, opposite bank?—Ed.

ing how they could afford to use this kind of construction, when, in feeling my way along the side of the tunnel, I got my fingernails full of rock; then it was perfectly clear; it is so soft it can be excavated about as easily as earth.

Constant walking on this material has pulverized it until the floors of these narrow passages are covered with a sandstone dust about an inch deep.

Branches run from the main tunnel to all parts of the city; all are equipped with electric lights, which are turned on and off by sections as you go through, so that the effect is as of being in a dimly lighted cave. We had gone about half a mile when Mr. Elinbacker said we were right under the hotel where I was stopping. Just then he stooped down and began to examine some tracks on the sandy floor. He arose with the statement that he guessed the rats were getting pretty numerous again. I immediately decided that if it wasn't feasible to shin up the cable and get into the hotel, we had better go right back where we came from. And this we did—quickly.

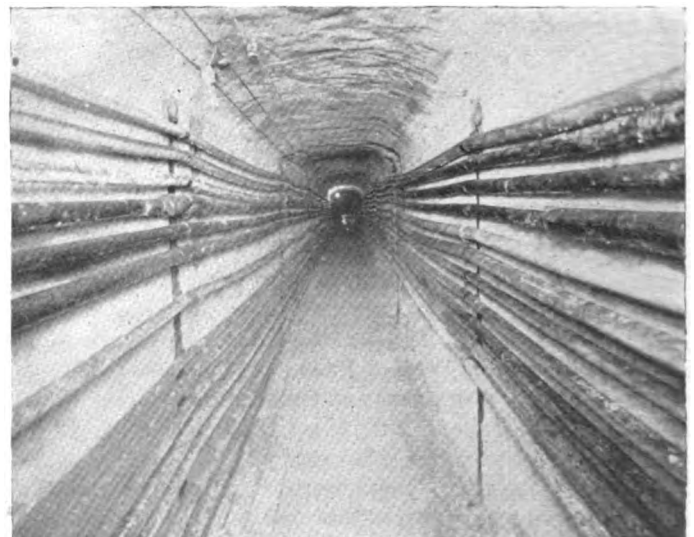

The Tunnel

HEARD IN THE SHOPS

ACTIVITIES OF THE MANUFACTURING DEPARTMENT AT HAWTHORNE

Who's Who at Hawthorne



—oh, my! (Aw, guess! Why, pshaw, that's nuts for squirrels!) L. Montamat's the guy.

Who knows what is it "loading rates," what "journal entry" means and such like dope that we poor skates just can't get through our beans? Who seams the Western's bills with care before he'll pay a cent? (At grabbing discounts he's a bear, but pays up like a gent.) Who ev'ry week sends 'round our pay—(for which we love him well) — wherewith we promptly beat the whey from old H. C. of L.? Who's tall and handsome — (girls, oh, gir-ruls!) but, dignified

In the Wake of the Draft

(Not a war poem, but Sherman might have classed this under his well-known synonym, too)

The iron door swings open wide;
The drafts rush in from every side.

Ten thousand times throughout the day
Our papers blow, and heck's to pay.

Ten thousand times—and maybe more—
Some goof forgets to "shut that door!"

That's all. We'll close this little hint.
There's more to say—but it won't print!

Speaking of Resemblance, This Looks Like a Scrape

"Purchase Mica" Marshall descended upon the apparatus drafting department recently, loaded down with a field buzzer switchboard. Like the lilies of the field, we know not, neither do we care, just why he was toting the contraption around, for it is about as big as a Kansas mortgage. However, it has a strap by which it can be hung around a person's neck, like the well-known millstone, and a man so equipped looks not unlike a sidewalk shoestring salesman. This resemblance struck Percy so forcibly that he shuffled into the drafting department office with the query: "Any shoestrings ti-day, gentlemen?" M. E. Berry looked at him and thought of a better resem-

blance. "Don't flatter yourself that you look as good as a shoestring man, Perce," he volunteered. "The thing's got a crank on it, and you look *your* part. All you need now is da monk."

Now Marshall has learned from hard experience in the war market never to let a good business opportunity get by. "All right, Berry," he offered promptly, "Come along. You're hired."

Unpopular Sports



Dinner to Captain M. K. McGrath

A dinner and theatre party were given to Captain M. K. McGrath at the Hotel Astor recently by some of his friends who were with him in Antwerp. These included A. H. Adams, W. E. Booth, P. E. Erikson, F. H. Leggett, F. Windt, W. E. Leigh, C. H. Minor, E. Montchyk and D. C. Tanner. At the dinner some special Flemish dishes were provided, which recalled happy days in Antwerp to those present.

Activities of the Hawthorne Club

The Outing at Riverview

RIVERVIEW AMUSEMENT PARK is so named because there is so much else to see that nobody cares whether he views the river or not. The river is there, though, and it is not hard to look at, either. However, the most beautiful river in the world couldn't hold its own as an attraction against the stream of pretty girls to be seen up there August 4th. When there are that many pretty faces in one place you can bet that bulge of bills in your trousers pocket that they came from Hawthorne. Only you'll have to look somewhere else for a taker, because nobody around here proposes to commit financial suicide contradicting you when you are supporting a sure thing. For Saturday, August 4th, was the date of the Hawthorne Club outing, everybody—members and non-members—invited. About 6,000 everybodies gladly accepted the invitation.

Now, we could easily run the printer out of exclamation points describing how joyful they felt over it, but nothing gives a reader mental indigestion as quickly as warmed-over enthusiasm. A brief description of some one else's good time generally satisfies the person who wasn't there. So if what follows strikes you as too garrulous, skip it.

The text was—"Eat, drink and be merry, for to-morrow you die." (And everything certainly does seem dead the to-morrow after a full joyous day like that one.) The expounding of the text took until almost midnight. For the eats—sandwiches, pie, candy, fruit, ice cream, etc., etc.—served by the Club, filled the bill for those who did not care to bring a picnic basket. For the drinks, there were 47 varieties of pop, plenty of water and lots of good coffee. And for the "be merry" there was everything your little heart could desire.

Club members were furnished with tickets good on the whirling wizzler, the spinning spinooza, the twisting twinopolizer, and other heart failure devices. The other Hawthorne people could buy tickets at reduced prices. In between rides there was plenty to watch.

The Shops took a well-played game of playground ball from the Offices, 4 to 2. The cable coverers from the C., R. & I. Shops lost a hot baseball game to the 'phone fabricators of the T. A. Shops, 5 to 1, although Dymik, of the losers, struck out 14 men.

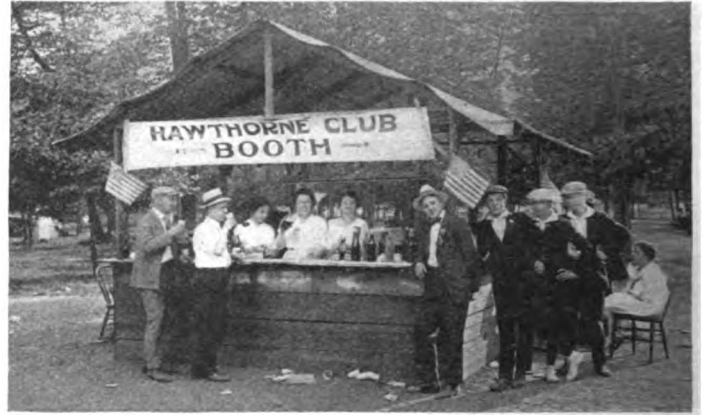

What Made Pop Popular. Some of the Club's Jolly Salesgirls at the Riverview Outing

And then there were races—girls' races, boys' races, young ladies' races, young men's races, egg races, shoe races, three-legged races, sack races, and, of course, a fat man's race. It may or may not be true that "nobody loves a fat man," but there is no disputing the fact that everybody loves to see him run. When it comes to sprinting he is there like a duck. You know what we mean.

However, there was also plenty of amusement for the more graceful. The ball-room was filled all afternoon and evening, and some of the more enthusiastic dancers hated to stop even for meals. But there is no disregarding the somewhat forceful hint of the home waltz, so the last one finally left, giving the tired entertainment committee a chance to hit the hay. And, say, "ain't it a grand and glorious feeling?"

The Garden Plot Thickens

There are three kinds of razors: The old-fashioned razor (collahed gen'leman model); the "safety," common or garden variety of razor; and the patriotic or garden raiser. The last type is very efficient for shaving weeds off the face of nature, leaving a nicely trimmed beard of fresh vegetables.

The effects produced by these keen instruments are clearly apparent in the Hawthorne Club garden tract,



Hawthorne Heart Breakers Turn Record Breakers at the Riverview Outing



The Northwest Corner of the Hawthorne Club Garden

which was pictured in an earlier issue of the News immediately after receiving a harrowing face massage to soften it up for the raisers. The accompanying illustration shows what it looked like a couple of months later.

About the only crops that proved complete failures were turnips and peas, both of which refused to live under the bone-dry administration of the weather man in charge of our mid-summer weather. However, most of the gardeners

planted diversified crops, so a few failures made but little difference. Practically every one is satisfied with the results of his season's work.

As estimates place the value of the produce raised on the Hawthorne plot at upwards of \$3,000, it is easy to see that "war gardens" all over the country have contributed very considerably to the nation's resources. Next year they will contribute much more if every one shows the same spirit as Hawthorne's enthusiasts, who are already boasting of what they will do in 1918 with this year's experience to guide them. Some of the more confident ones even go so far as to threaten all gardening records if the Club reopens the plot next season.

The tract was put under cultivation for the first time this year and was not, of course, ideal for gardening. By next year, however, the turned-under sod will have decomposed, adding to the fertility of the ground and making it more easily workable. And conservation of the early spring backache is something of vital interest to amateur gardeners. Most of them can get along with very little of it, and many are willing to dispense with it altogether.

However, the trouble easily yields to a treatment of nice fresh vegetables later in the season. Indeed, the tempting flavor of the remedy has led many to overdo the treatment, so that instead of eliminating the backache they have merely caused it to rotate through 180 degrees. But then things taste so good when a man raises them himself that he has some excuse for overloading his stomach now and then.

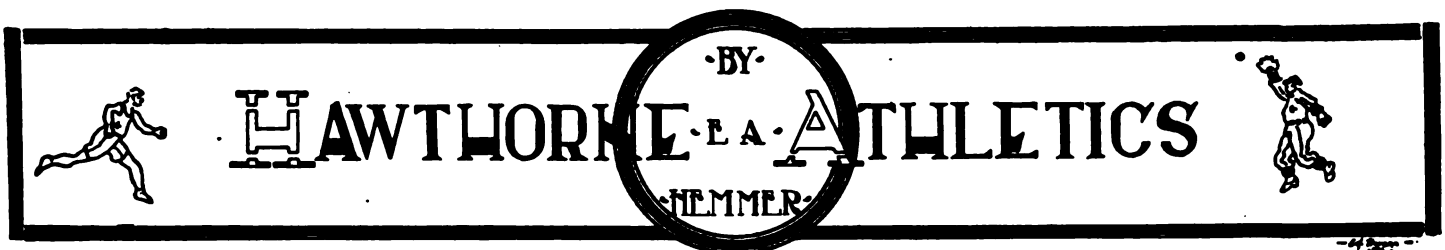

Stewart-Warner Team Loses at Hawthorne

The Stewart-Warner speedometer boys tackled the Western Electric speed boys July 21 at the Hawthorne grounds. After measuring our team's speed they admitted defeat by a score of 9 to 5. McGuire, Maager and Young each took a turn at the hurling for us and together struck out seventeen men. Our boys took fifteen safe wallops at Nelson's binders.

The score:

STEWART-WARNER COMPANY					WESTERN ELECTRIC COMPANY					
R.	H.	P.O.	A.	E.	R.	H.	P.O.	A.	E.	
Bein, lf.	0	1	0	0	Ginners, ss.	3	3	3	0	
Murphy, 3b.	2	3	0	5	Chouinard, cf.	0	2	2	0	
B. Lebbin, ss.	2	0	2	0	Jameson, 2b.	1	2	1	1	
Darling, 1b.	0	2	13	1	Engelhardt, rf.	0	0	1	0	
Brundage, rf.	0	0	2	0	Tennant, 1b.	1	2	3	0	
Kasman, 2b.	0	0	3	5	Evans, 3b.	1	1	2	0	
Rodeman, cf., p.	1	1	0	3	Swanson, lf.	1	3	0	0	
North, c.	0	0	4	0	Rehor, c.	1	2	15	3	
Nelson, p., cf.	0	0	0	1	McGuire, p.	0	0	0	0	
					Young, p.	0	0	0	1	
					Maager, p.	1	0	0	0	
Totals	5	7	24	17	0	Totals	9	15	27	5
										3

	1	2	3	4	5	6	7	8	9
Western Electric Company	5	1	0	0	0	3	0	0	*—9
Stewart-Warner Company	0	0	3	0	0	0	2	0	0—5

Summary: Two-base hits—Ginners (2), Rehor, Jameson, Murphy. Three-base hits—Swanson, Darling (2), Rodeman. Home runs—Jameson, Rehor. Double plays—Rodeman to Kasman to Darling, Kasman to Lebbin to Darling. Struck out—By McGuire, 6; Maager, 5; Young, 6; Nelson, 1; Rodeman, 1. Base on balls—By McGuire, 1; Maager, 1; Young, 1; Nelson, 1; Rodeman, 3.

Illinois Tool Works Take a Trimming

Nelson, who handles the horse-hide for the Illinois Tool Works team, has always been a hoodoo for our sluggers, but they had their rabbit's foot with them at Garden City Park July 28th, and rapped his toughest twisters all over the lot. Incidentally, Dick Cantwell staged a nice little life-saving act. Dick was rushed up from the rear when the enemy had forces on second and third, with no casualties. His bomb-throwing stopped all further attacks, and the advanced base positions were surrendered by the enemy, who had been able to progress no further. Kavanaugh's home run, with the score 4 to 4, started our boys on to victory.

A summary of the battle follows:

ILLINOIS TOOL WORKS					WESTERN ELECTRIC COMPANY						
R.	H.	P.O.	A.	E.	R.	H.	P.O.	A.	E.		
Foreman, 3b.	0	0	0	1	0	Ginners, ss.	1	2	2	1	0
Armstrong, c.	0	0	5	1	0	Fox, rf.	1	2	2	1	0
Bullen, 2b.	1	2	4	2	1	Jameson, 2b.	0	2	2	5	0
Kilby, 1b.	2	2	9	1	0	Kavanaugh, lf.	1	2	0	0	0
Ullman, rf.	1	3	2	0	0	Tennant, 1b.	1	1	10	0	0
Spreitzer, ss.	0	2	2	3	1	Swanson, cf.	0	2	1	0	0
Murphy, lf.	0	1	0	0	0	Evans, 3b.	0	0	2	1	0
Anderson, cf.	0	1	2	0	0	Chouinard, 3b.	1	0	0	0	0
Nelson, p.	0	0	0	3	0	Rehor, c.	1	0	4	3	0
Totals	4	11	24	11	2	Reed, c.	1	1	4	1	0
						Young, p.	0	0	0	2	0
						Maager, p.	1	0	0	0	0
						Cantwell, p.	1	1	0	1	0
Totals	4	11	24	11	2	Totals	9	13	27	15	0

WESTERN ELECTRIC COMPANY										ILLINOIS TOOL WORKS										
1	2	3	4	5	6	7	8	9	*	1	2	3	4	5	6	7	8	9	*	
Western Electric Company	1	0	0	0	2	0	1	5	*-9	Illinois Tool Works	0	0	0	2	2	0	0	0	0	-4

Two Out of Three from the U. S. Ball Bearing Company

Cragin Park saw the opening of our three-game series with the U. S. Ball Bearing Company's team August 1st. The result sounds like a report of a game of solitaire, for W. E. beat U. S. 5 to 1. Cantwell contributed the curves for our team, and kept them so well assorted that 10 batters missed connections altogether.

Below is the score:

U. S. BALL BEARING COMPANY					WESTERN ELECTRIC COMPANY						
R.	H.	P.O.	A.	E.	R.	H.	P.O.	A.	E.		
Rudolph, 2b.	0	0	3	2	2	Ginners, ss.	1	4	3	2	1
Sundheim, ss.	0	2	4	2	0	Fox, rf.	1	1	0	0	0
Callahan, lf.	0	1	1	0	0	Jameson, 2b.	1	2	4	2	0
Ness, 1b.	0	1	5	3	0	Kavanaugh, lf.	0	0	4	0	0
Harley, cf.	0	0	4	0	0	Fiene, 1b.	0	0	4	0	0
Olson, rf.	1	0	2	0	0	Swanson, cf.	1	1	1	1	0
Schutte, 3b.	0	1	0	1	0	Chouinard, 3b.	0	1	0	1	0
Dennis, c.	0	2	6	0	0	Rehor, c.	1	0	11	0	0
Zeizer, p.	0	0	2	1	0	Cantwell, p.	0	0	0	3	0
Totals	1	7	27	9	2	Totals	5	9	27	9	1

WESTERN ELECTRIC COMPANY										U. S. BALL BEARING COMPANY											
1	2	3	4	5	6	7	8	9	*	1	2	3	4	5	6	7	8	9	*		
Western Electric Company	1	2	0	0	0	0	0	0	0	-5	U. S. Ball Bearing Company	0	0	0	1	0	0	0	0	0	-1

The following Saturday our boys acted as hosts at Hawthorne, and dished up another nice little defeat to the Bearing Boys. This game was a close one, with nobody but the pitchers doing much to the ball. Our boys managed to get three bingles, but Zeizer's pitching was mostly hit-proof. McGuire only allowed one safety. In addition to pitching a fine game, Mac. scored our lone tally.

Here are the details:

U. S. BALL BEARING COMPANY					WESTERN ELECTRIC COMPANY						
R.	H.	P.O.	A.	E.	R.	H.	P.O.	A.	E.		
Schutte, 3b.	0	0	0	2	0	Ginners, ss.	0	1	2	3	0
Sundheim, ss.	0	0	1	5	0	Fox, rf.	0	0	1	0	0
Callahan, lf.	0	0	1	0	0	Jameson, 2b.	0	1	1	2	0
Ness, 1b.	0	0	14	0	0	Kavanaugh, lf.	0	0	0	0	0
Harley, cf, p.	0	0	2	0	0	Fiene, 1b.	0	0	7	0	0
Olson, rf.	0	0	2	0	0	Swanson, cf.	0	0	6	0	0
Egan, 2b.	0	0	1	1	0	Evans, 3b.	0	0	1	1	0
Dennis, c.	0	1	3	0	1	Rehor, c.	0	0	9	3	0
Zeizer, p.	0	0	0	4	0	McGuire, p.	1	1	0	0	0
Jensen, rf.	0	0	0	0	0						
Totals	0	1	24	12	1	Totals	1	3	27	9	0

WESTERN ELECTRIC COMPANY										U. S. BALL BEARING COMPANY										
1	2	3	4	5	6	7	8	9	*	1	2	3	4	5	6	7	8	9	*	
Western Electric Company	0	0	0	0	0	0	0	1	*-1	U. S. Ball Bearing Company	0	0	0	0	0	0	0	0	0	0

Summary: Base on balls—By McGuire, 3; Zeizer, 2; Hartley, 1. Struck out—By McGuire, 8; Zeizer, 2; Harley, 1. Hit by pitcher—Harley, Ness. Double plays—Rehor to Jameson to Fiene, Evans to Ginners.

August 8th, at Garden City Park, luck broke for the Bearing Boys, and they took the last game of the series, 2 to 1. Only four hits were made off Cantwell, while our batters got eight from Stremmel, but unfortunately they did not come when they would have done the most good.

The score:

U. S. BALL BEARING COMPANY					WESTERN ELECTRIC COMPANY						
R.	H.	P.O.	A.	E.	R.	H.	P.O.	A.	E.		
Schutte, 3b.	0	1	2	4	0	Ginners, ss.	0	1	1	0	0
Sundheim, ss.	0	0	1	3	1	Fox, rf.	0	0	0	1	0
Callahan, lf.	0	1	1	1	0	Jameson, 2b.	0	1	1	0	0
Ness, 1b.	0	0	10	1	0	Kavanaugh, lf.	0	2	6	0	0
Harley, cf.	0	0	3	0	0	Fiene, 1b.	0	1	5	0	0
Olson, rf.	1	1	4	0	0	Swanson, cf.	1	1	2	0	0
Peterson, 2b.	1	0	2	4	0	Evans, 3b.	0	1	2	2	0
Dennis, c.	0	1	4	1	0	Rehor, c.	0	1	5	0	1
Stremmel, p.	0	0	0	1	0	Cantwell, p.	0	0	2	2	0
Totals	2	4	27	15	1	Totals	1	8	24	5	1

McGuire batted for Evans in ninth. Engelhardt batted for Evans in ninth.

WESTERN ELECTRIC COMPANY										U. S. BALL BEARING COMPANY										
1	2	3	4	5	6	7	8	9	*	1	2	3	4	5	6	7	8	9	*	
Western Electric Company	0	0	0	0	1	0	0	0	0	-1	U. S. Ball Bearing Company	0	0	0	0	0	2	0	0	*-2

Summary: Two-base hits—Kavanaugh, Jameson, Dennis. Stolen bases—Ginners, Rehor, Schutte. Struck out—By Cantwell, 4; Stremmel, 3. Bases on balls—By Cantwell, 2; by Stremmel, 2.

Standing of League at Press Date

	Won	Lost
Illinois Tool Co.	9	2
Western Electric Co.	9	3
U. S. Ball Bearing Co.	8	3
T. E. Wilson & Co.	3	9
Stewart-Warner Co.	0	12

Tennis

Why and How

MOST inexperienced players make the mistake of assuming that all that is necessary for playing tennis is a ball and a racket. The result is that they never get anywhere. We have made an exhaustive study of this subject, and we found that the thing needed most is an alibi. When your serve goes into the net at every attempt, and the only place you can place the ball is just outside the tape, an alibi will save your self-respect, and when the other fellow seems to have perfect control and serves, lobs and volleys all over the court except where you are, the alibi explains it all.

Realizing this fact, and driven by the desire to help our fellow players, we have interviewed some of our best players and gathered the following choice list of alibis. These alibis have all been tried out in actual play and if you adopt one of them you have an even chance of getting away with it.

The first one on our list is to be used by elderly people and only when they have been losing consistently. It is recommended by R. D. Berry—5946. He says, "I am getting too old and fat."

A real scientific alibi, which works like a charm as long as you are not asked to explain it, is given by J. H. Biggar—6961-A. He blames it all on the "green background."

Of course you can always admit that the other fellow is better than you. That's what E. A. Hess—6435—usually does, but he makes the reservation that it takes a good player to beat him. Last time he lost he said: "That bird played TENNIS." R. D. Williams—6970-A—says, "Nothing to it—he sure pulled my cork."

A. C. Johnson—6547—is surprised every time he meets a better player than himself. He says he doesn't know where they all come from. We get more surprised when we beat a fellow.

Then there is always the alibi that you are out of condition. It is no use, however, to mention this fact before you start to play, because if you win it would be a good alibi wasted. In fact, most people do not discover that they are out of condition until after they have lost. We give a few of the best. J. H. Biggar—6961-A—used as his: "Couldn't get my second wind. He ran me out of gas." G. W. Johnson—7487: "Something was the matter with me, but anyhow I need practice against that kind of a player." J. F. Grosvenor—6130: "It was very unfortunate, but I wasn't playing my game at all." L. W. Langborgh—6967: "No pep." (Whad'ye mean, "No pep"?) We had to repair the backstop after the last time you played.) S. Crowley—6968—says: "All in, fellows." (They must lead a hard life at Fort Sheridan.)

The girls have their own set of alibis, but most of them use this one:

"Might as well default,
She'll beat me anyway."

We did, however, get a few representative ones after a lot of hard work. Here is one from Irene Kolacek—6112:

"Cheer up, with a little more practice I'll beat her." (We hope Irene will get the practice.) Anna Stahr—6410—gave us this one: "I knew she would feel bad if I beat her, so I really didn't have the heart. (That wasn't the way she felt when she played us, but she may have changed since that time.)

Three of the girls we interviewed got so inspired by the subject that they broke into free verse—very free, indeed. We are giving the poetry here just to show what hardships we had to go through in order to select the material for this article. Olive Hoppe—6615—declaimed:

"A favorite alibi I have not,
For sometimes I'm tired
And sometimes I'm hot,
But 'tis a general thing
That out of form
I'm always."

Listen to this one from Everelda Patterson, the poetess laureate of Department 6450:

"A little more practice,
A little more pep,
The next time she challenges me
I'll spoil her 'rep.'"

Ella Hoppe—6400—says:

"My racket's no good—I need a new one so bad,
And besides the hot weather is driving me mad."

If none of the above mentioned ones fit your case you can always fall back on the old reliable excuse, "He called them out on me." However, this should be used only if you have a mean disposition or a reputation for being a bad loser.

—J. M. S.



At the Credit Men's Meetings

THE Company had seven representatives from the Credit Department at the Twenty-first Annual Convention, National Association of Credit Men, held at Kansas City recently. The Kansas City Local Committee attended the morning session on the second day, headed by Manager F. B. Uhrig, who is one of the Company's first Credit Men. District Manager Cullinan was also present. A Western Electric luncheon followed at the Hotel Baltimore.

Two Western Electric Credit Conferences were held at the Hotel Muehlbach after Convention sessions. C. E. Vandel, Credit Manager at Kansas City, was elected to the National Board of Directors of the Association, the first Western Electric or other electric man to be so honored. Mr. Vandel was formerly president of the Kansas City Association, and his election is in recognition of his labors and qualifications.

The National Electrical Credit Association also met at Boston recently. Our Mr. Browne, of Philadelphia, attended, as did Mr. Curran, who was Chairman of the Arrangement Committee.



The Credit Men's Convention, Kansas City, Mo., Recently. First Row (left to right): E. W. Shepard, Credit Manager, Cleveland; W. A. Williford, Credit Manager, St. Louis; E. B. Gilmore, Credit Manager, Chicago; C. E. Vandel, Credit Manager, Kansas City; H. L. Harper, Sales Manager, Kansas City; E. L. Spolander, Stores Manager, Kansas City, Upper Row (left to right): M. A. Curran, General Credit Manager; G. E. Cullinan, District Manager, St. Louis; J. J. O'Reilly, Credit Manager, Seattle; A. V. Willett, Credit Manager, Dallas; F. B. Uhrig, Manager, Kansas City

Come On Out---the Weather's Fine

OUTINGS have certainly been having their innings at Hawthorne recently. Three big ones in a row, one each week, rather establishes a plant record for outing output.

Assembling Department Starts Things

On Saturday morning, July 28, there was no assembling done in the T. A. Shops, the reason being that all the assemblers were assembling elsewhere. "Elsewhere," of course, would mean Schuth's Grove. Else, where else? For that was where the outing was to be, and nobody had any intention of missing it.

All the assembling departments and the inspection departments associated with them were invited, with families included in the invitation. The attendance was about 2,200.



Part of the Peach Crop at Schuth's Grove on the Day of the Assembly Department's Outing

A big program of games and races furnished much amusement for both spectators and participants. All day long there were dancing and bowling. Two sections of the Western Electric Band helped make things lively, one furnishing inspiration for the dancers and the other instilling ginger into the athletes.

Watching eighteen races and three baseball games, besides dancing a little, bowling a little and eating a lot, is enough enjoyment to call it a day. It was—a big one.

Jobbing Departments Take the Next Saturday

Now, as far as the assembly departments were concerned, that finished the matter. But for ye scribe life is just one darned outing write-up after another. Hardly is one pencil chewed up describing one grand, good time than another bobs into view with a consequent depletion of the nation's supply of lead pencils. Where's that man Hoover, anyway?

It seems that the jobbing departments held an outing August 4. Our informant was quite positive that it was the finest ever held—best weather, best crowd, best games, best races. And you can't dispute with a man who knows, and knows he knows. So probably it was. He will have to fight it out with the others making similar claims. We're as neutral as a nigger at a St. Patrick's Day fight.



A Partial Assembly of S. Dewberry's Family at the Assembly Departments Outing. The Seventh Got Lost Out of the picture



Pick the Winner! Watermelon Race at Machine Department's Outing

We gather that there were about 1,000 jobbers on the job of scattering sunshine on each other all day long. The place was Stickney Grove. At least, that's what it sounds like. "Spell it 'c-h' or 'c-k-n-e-y'?" we ask. "Oh, I don't care; suit yourself," replied our informant liberally.

He doesn't believe in making an issue of a little matter like spelling. And yet that man will fuss more over a thousandth of an inch than we will over a foot when our corns are behaving the worst.

Well, every man to his trade. Ours is spelling. And even if we haven't done a perfect job on that "Stickney,"



A Group of Merry Makers at the Machine Department's Outing

we hope it will slip by while the orthography inspector is napping.

Anyway, Stickney was the scene of a supersatisfactory outing, which is what we started out to tell in the first place.



The Committee at the Jobbing Department's Outing

Another Day; And Other Doings

After that everything was all right until the 'phone bell rang on August 13. Yes, this was 1099. Didn't we have something to do with the WESTERN ELECTRIC NEWS? We pleaded guilty and threw ourselves upon the mercy of the court.

But there was no mercy to be had. No, indeed. The voice on the other end had an outing to report! This time it was the machine departments, who had turned out about 3,000 strong to enjoy Saturday at Schuth's Park. It was the best crowd, the best day, the best games, the best—

"Yes, yes; go on!" we implored. "Your words seem to awake strange memories. Where, oh where, have we heard that claim before?"

However, even if there are two other department outings to dispute the machine department's claims to "the very best," there is no disputing the fact that everyone there had such a good time he *thought* it was the very best, and that, after all, is the supreme test of an outing.

FOREIGN NOTES

SOME ITEMS OF INTEREST FROM ABROAD

From Uruguay

The accompanying photograph has recently been received from the Montevideo Telephone Company of Uruguay, showing a board which had been made in the repair shops of the telephone company from parts of a multiple switchboard which was manufactured by the Western Electric Company of America and had been in constant service for twenty-six years, when it was replaced about two years ago with a lamp signaling type board.

E. B. Manley, who, since the war has been acting as Shop Superintendent at Paris, reached New York

with his family August 9. He expects to remain in America about two months, part of which time will be spent at Hawthorne.

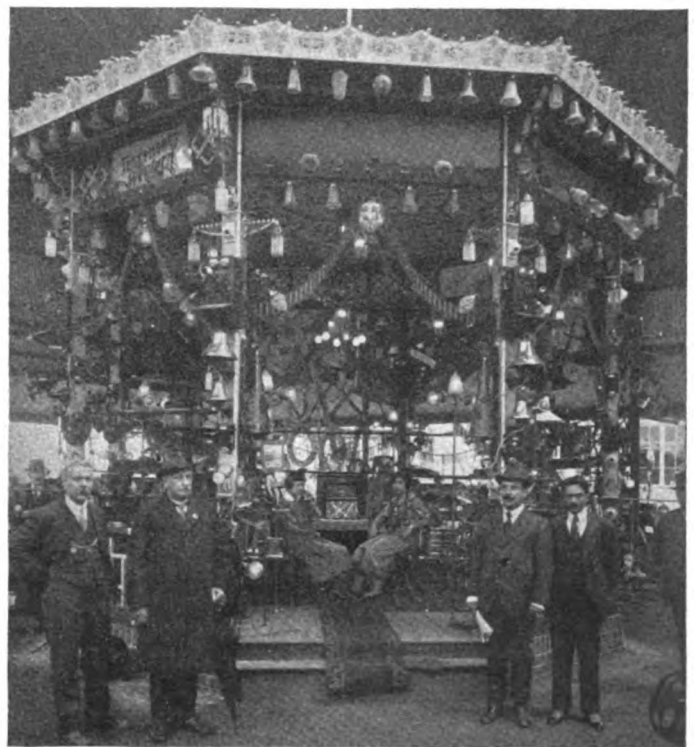

Here is An Exhibit of Electrical Products Carried in Stock By One of Our Customers in Brazil, Nearly All of Which is Western Electric Apparatus and Supplies. Note the Switchboard in the Center and No. 1317 Sets on the Standard

Their Earliest Ambitions

And How They Earned Their First Money—First Installment of the Revelations and Confessions from the Innermost Souls of Many Western Electric Men

Shades of Rembrandt!



FOR years I wanted to be an artist, and am not sure whether I was finally cured by the tragic pathos of a cow done in oil by an aging spinster acquaintance, or my first correct winding diagram for a 3-phase generator stator. I sometimes think I have met more artists in business than I could have found in the studios—hot air—

alibi—shipping promise, etc.

J. W. CARY,

Sales Manager, Pittsburgh.

Voorhees' First Impressions

Living on a farm in my boyhood days, the biggest and most wonderful thing in sight was a railroad train, and my first youthful ambition was to be an engineer.

My first money was earned by selling cucumbers from my mother's garden without permission. A couple of days after the first sale an impression was created on me by my mother, resulting in my never failing to remember the occasion.

C. S. VOORHEES,

Asst. Contract Sales Manager.

This explains a whole lot we never understood before.—ED.

We Know Just How You Felt

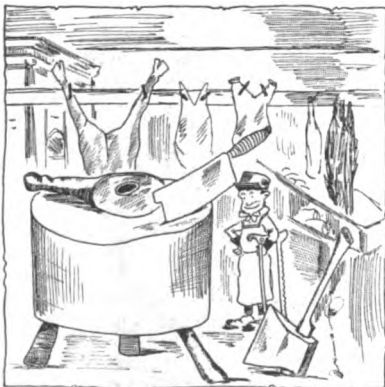

If I remember correctly, my first youthful ambition was to own a butcher shop. Not all boys get the "tenderloin" out of the family porterhouse steak, and, as a youngster in the negative class, I craved the tender portion. The proprietor of a butcher shop appeared to me as particularly fortunate because he could have "tenderloin" whenever

he wanted it. Later developments in my life indicated that my ambition could be realized, and was realized, but in a different channel.

C. D. WILKINSON,

Manager, Minneapolis.

Thanks to His Secretary

To the Board of Editors:

Referring to yours of June 4th, to Mr. W. F. Bancker, requesting the story of his earliest ambition in fifty words, Mr. Bancker is quite sure that the NEWS readers would not be interested in his earliest ambition and, anyway, he doesn't like to talk about himself. Incidentally, however, he has assured me before that his earliest ambition was to be a minister—that this was his first thought for some time; in fact, until he earned his first money raking leaves, picking cherries, etc., when he decided he wanted a more lucrative position and decided to become an expert accountant—and eventually came to the Western Electric.

K. MACINTYRE,

Secretary to Mr. Bancker.

"J. W." Passes the Buck to His Son

Recollections of my own first youthful ambition are not very clear, but I remember very well when my son was about five years old. He came one day in a spirit of confidence to his mother and said:

"Mother, I have made up my mind that I want to be either a street-car driver or keep a candy shop."

His mother was duly impressed, but in a few days he came to her again and said:

"I have changed my mind. I am not going to be a street-car driver nor keep a candy shop, but I want to be just a common man like father."

J. W. JOHNSTON,

Treasurer.

Here Was a Young Daredevil!

When I was fourteen years old an elder brother who was in the grain business in Nebraska gave me a job. This was about the time that old "Hutch" cornered wheat, and the stories of his fabulous profits appealed to my youthful imagination to such an extent, I remember, that I was consumed with an ambition to corner a market.

R. W. VAN VALKENBURGH,

Manager, Dallas.

Sails, Then Shoes, Then Sales

My early ambitions were many and varied, but the one which I remember most pointedly was a very large ambition to become a mariner. I wanted to sail the briny deep, driving my full-rigged ship into the teeth of a biting Nor'easter.

My first money was earned in delivering handbills from door to door for a local shoe store. The work was performed after school and the remuneration was *twenty-five cents per trip*, the latter consuming about three hours. In those days this was a profitable (?) occupation because shoe leather was not as expensive as it is to-day.

W. F. ABELY,

Sales Manager, Boston.

Western Electric

Vol. V. No. 8

News

Oct., 1916

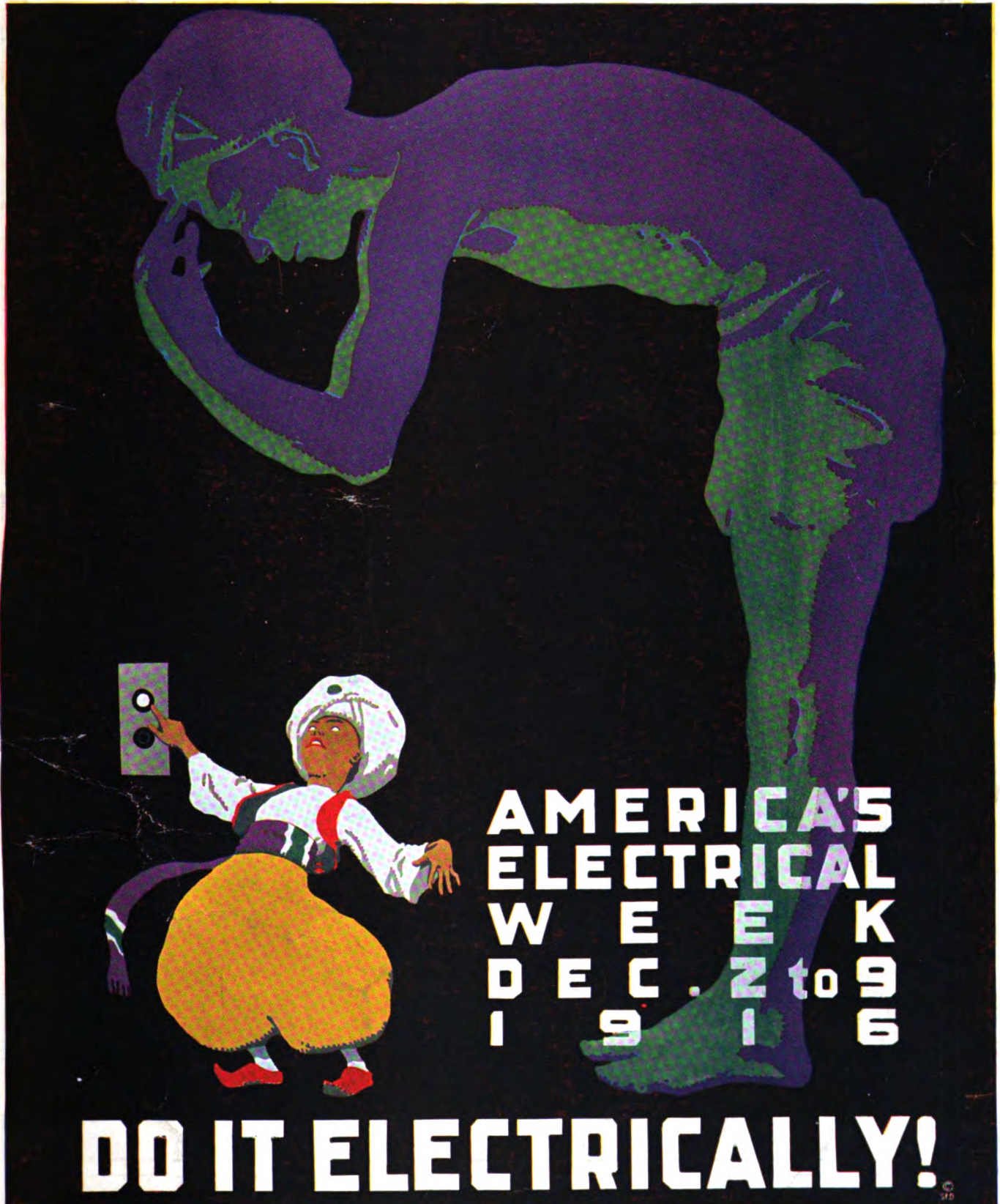

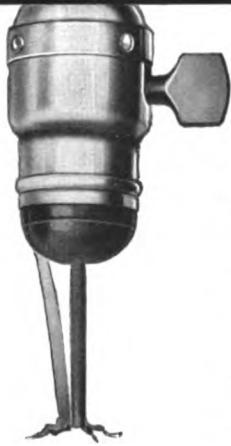

Wash With Electricity—The Easy Way— The Sanitary Way—The Economical Way

Right in your own laundry—in the electric light socket—is all the power necessary to do your washing. Why go on with the old-fashioned washboard or hand-washer way? Why not take advantage of the help so close at hand and which costs so little?

In these days when the servant problem looms larger than ever before, many women are finding the solution in the electrical appliances that reduce domestic labor.

This is especially true of the

Western Electric Washer and Wringer



It removes the drudgery that drives help from the household field and it more than repays the owner in servant's time saved and in lessened wear and tear on clothes.

In the Western Electric Washer the clothes are gently rocked back and forth in hot suds, in a smooth, perforated, revolving cylinder. No attention to the washer is needed while at work. The mechanism which operates it is enclosed. The wringer is reversible. The whole apparatus is quickly cleaned after using. Attaches to any electric light socket and uses very little current.

You can arrange for a *Free Trial* in your own home. Take advantage of this opportunity. Write to us for particulars. Drop a postcard to our nearest house and ask for Booklet No. 97-S.

WESTERN ELECTRIC COMPANY

INCORPORATED

New York
Buffalo
Newark
Philadelphia
Boston

Atlanta
Richmond
Savannah
New Orleans

Pittsburgh
Cleveland
Cincinnati
Detroit

St. Paul

Chicago
Milwaukee
Indianapolis
Minneapolis

St. Paul

Kansas City
St. Louis
Dallas
Houston

Denver
Salt Lake City
Omaha
Oklahoma City

San Francisco
Oakland
Los Angeles
Seattle
Portland

EQUIPMENT FOR EVERY ELECTRICAL NEED

This Advertisement Appears in the October Issue of "World's Work"

With the Western Electric Rookies

Life at Plattsburg During the August Encampment

By P. K. Condict



Rookie Condict

HAD you been at the Grand Central Station after dinner on the evening of August 9th, you might have thought that New York City was about to be invaded or that there was another street car strike. But such was not the case. It was merely part of the contingent for the August military camp at Plattsburg. Most of the men seemed to be not quite sure of their

uniforms, but occasionally a proud figure hurried down to one of the several special trains with an old service hat and faded cord, showing that he had been to a previous camp and was not afraid to try it again. This gave us new hope and our spirits rose still higher as one by one the New York Western Electric Rookies appeared, until all our brave and gallant band was assembled: Condict, Craft, Englund, Jones, Lack, Kendall and McGrath. The engineers, six out of seven, had somewhat the weight of the argument; especially when one Sultzer arrived, late of our number, now promoted to the Telephone Company. We got under way a half hour late, so no one could say that he just missed the train, and cheers arose from wives and sweethearts of those who were fortunate enough to have such there. Unfortunately we had neither—there.

We Lose Each Other

We were all up bright and early next morning, ready to start our army life, and by 6:30 were seated in the mess shacks, eating a breakfast which gave us a most favorable opinion of war. After making sure that we were strong enough for any immediate service, we made our way to the enrollment bureau, with some 3,500 other unknowing individuals, and were assigned to company and regiment; and after that our little band was so scattered that it was a stroke of the greatest military genius to round them up at one time to make the record for future generations which we show you here. Even on the seventh attempt we were deprived of the presence of our two colleagues from Philadelphia—Hannan and Vaughan; so we have to show them separately, and possibly, they prefer it so, after seeing the group.

When we went to our several companies, where our enlistment cards were presented, we were interviewed and carefully looked over by the C.O. and asked if we were afraid of hard work, and under the circumstances it seemed wise to allow that we were not. This ordeal being acceptably terminated, we were given, by a benevolent government, a cot, mattress and cover, pillow, two blankets, poncho, half a shelter tent, mess kit, sweater, haversack, cartridge belt, bayonet and rifle. The cot was soon lined up along with seven others in the tent, and our



Regimental Parade at Plattsburg

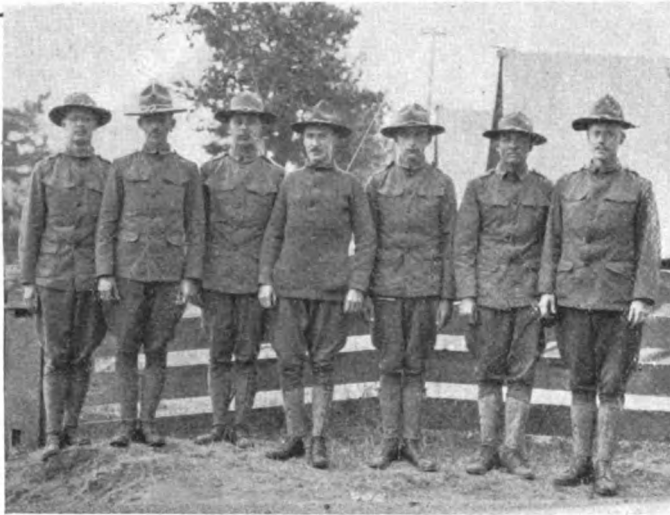

WESTERN ROOKIES AT PLATTSBURG

From Left to Right: Kendall, Jones, Craft, McGrath, Lack, England, Condict.

equipment and stuff stowed under it, and we learned almost immediately, that each piece had to be placed in a very neat and exact position, under penalty of appearing on the delinquent list. While our company mates were arriving, we had time to learn something from the regular Sergeant and Corporal (one of each being attached to a company) about cleaning the rifle, and the knowledge gained we found was of daily and almost hourly necessity during the ensuing month. I found this out, to my sorrow, on the first inspection of my rifle, when, after hours of cleaning, I was stood out two paces in front of the company, not alone, however, for having a dirty rifle, feeling like a whipped school boy, threatened with the delinquent list almost at the outset of my military career. I learned more about cleaning that blessed rifle, the soldier's best friend.

It Was Good Food

In the intensive training given at Plattsburg not a minute of daylight is allowed to be wasted, and it seemed to us as though the bugles were timed to blow every 4½ minutes for something. We were lined up for dinner the first noon and marched over to the mess shack, and the Captain of our company seized the opportunity to teach us a little more about the army step (30 inches, 120 to the minute, 1, 2, 3, 4) by marching us around by the road to meals, for two weeks, about a mile and very hot. Each company had a mess shack, tables and benches; and with many men, any table manners and thoughts of the rights of others to participate, seemed to be forgotten when we were ordered to "Take Seats" and the food hove in sight. We had good substantial food, well calculated to keep up the inner man during our hard work. The mess shacks and kitchen were kept very clean; wet sand on the floor, tables scrubbed off regularly, mosquito netting for the sides of the rooms, and fly traps in abundance around the buildings.

For cleaning up, we had shower baths for each two companies, and, when enough minutes could be secured, a swim in Lake Champlain, just below the camps, was a great help in washing away our often tired feelings. It was most interesting to see the sanitary arrangements

made by the Army authorities and the requirements for cleanliness throughout the camp, and yet everything of the simplest design and form imaginable. Each company was obliged to keep its own "street" in spotless condition, and this duty was usually performed by the delinquent squad. Some of the men learned to spot a cigarette or piece of paper at very long ranges indeed.

Said Eddie Craft to P. K. Condict:
 "That White-Wing Work—How Can You Stand It?"
 "I've Got to," P. K. Condict Laughed,
 Unto the Idle Eddie Craft.

I shall not soon forget my first Sunday, the day of rest. After digging a trench about the tent I was living in, to keep off floods, I was moved to a new tent, the gentlemen included in which had already been assigned to Police duty that day. I was not quite used to receiving and obeying orders from almost anyone in sight, but in spite of that I soon found myself hunting for any stray cigarette ends, bits of papers or weeds in the Captain's "front yard." Eddie Craft, who came around in a beautiful uniform and with clean hands to take me to lunch at the Hotel, seemed unduly amused, and it took some time to persuade him to recognize my official position and pass on.

The Day's Work

To some of us who are semi-early risers, the hours of labor seemed questionable. Reveille blew at 5:45 A. M. and gave us ten minutes to fall in, during which short interval the post band usually tried to cheer us up. Mess call came at 6:25; hospital call, for any with sore feet or



ROOKIES AT TARGET PRACTICE

P. K. Condict, Extreme Right Background, Albeit His Sleeves are Rolled Up, Does Not Seem to be Very Busy.



Even if This Picture Wasn't Titled You Might Know That It Showed Mess Call. See Craft First in the Line!

other infantry ailments, was at 7; first call for drill, 7:20; falling in at 7:30 (after a few days, with packs and rifle added to our ordinary weight). We marched to the parade grounds and were given setting-up exercises for a half or three-quarters of an hour by the West Point Physical Director, who is the most noted man in the world for thinking out peculiar positions in which to place the human body. After being well stiffened up, we started the morning's drill, first on the parade ground until we learned something about close order formations and then marching out the Peru road for sham battles. If any enemy even dares to send a force down that road there will be opposition from men who know the feeling of every rock, swamp, bramble bush and hill along the route. Each day some new form of attack, defense or retreating problem was acted out and then an explanation of improvements given by the captain or major. We were usually ready for the several miles' return journey and dismissal at 11:30.

Every Man His Own Washwoman

At noon the dinner bugle blew and from 2:00-2:30 in the afternoon we had more drill or rifle practice until 4 P. M. Then was the great time for cleaning your rifle, yourself and possibly doing your laundry work; for some one had been very remiss in their failure to sell Western Electric Washing Machines at Plattsburg and all the laundries were on intermittent or continued strikes. At 5:30 we fell in for Retreat, which included rifle and tent inspection and a salute to the colors. A most impressive sight it was when both regiments were lined up at attention to do honor to the colors, while the band played the Star Spangled Banner and the flag came down.



An Armored Automobile at the Plattsburg Camp



Rookies Riding in Their Special "Gondola-Pullmans"

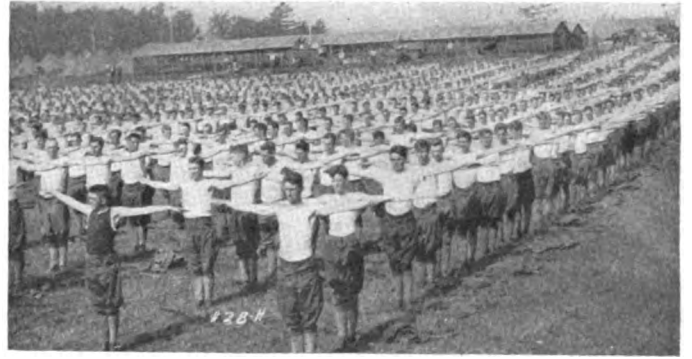

Hardening the Rookies' Muscles by "Setting-Up" Exercises

At 6 o'clock supper blew and after that a company, battalion or regimental conference was held, often two out of the three. By 7:30 we were usually free to go down and buy an ice cream cone, or write letters in the shacks which were so very kindly provided by the Y. M. C. A. Most of us were ready for our cots by 8 or 8:30. At 9 o'clock lights were out, meaning a lantern provided for each tent, and at 9:30 Taps blew and tents were inspected to see that each little soldier was tucked in bed as he should be. And so came the end of a perfect day, one of which closely resembled another until the last week of manoeuvres.

The Enemy Soaks the Rookies

On one day, however, our battalion was taken on an all-day hike. Our company and another fought their way against the other two companies for 5 or 6 miles out into the country over roads and fields and golf links, much to the annoyance of one farmer's wife who brought out her large dog only to be further annoyed by his failure to even bark at such a formidable foe and watching him shrink back into the house. But we were always instructed to be careful of cultivated fields, as the Government had to settle any damage claims. At noon we were served bread, beans and coffee from one of the new type army kitchens which travelled out with us on its four wheels. After lunch we marched about two miles further only to encounter the enemy in the shape of a most severe thunder storm and a long march back to camp in the downpour which followed. In those sham battles the greatest danger came from having enthusiastic Rookies fire a blank almost into your ear and many a man seemed to think he had been so attacked.

Each company had 2 or 3 days on the rifle range, firing 10 shots each, at slow fire at 300, 500 and 600 yards and the same number at rapid fire on the 200 and 300 yard ranges. No inhabitants of the country were killed, but much lead was planted in the sand bank and trees below and above the targets. However, it was great sport, and most of us managed to come through with a fair average for beginners.

Life in a Pup Tent

The last week of the four was given up to the hike and manoeuvres. We started off one noon from Plattsburg by rail, both regiments being loaded very rapidly into a long train of coal cars. It is an interesting study to see how little one can get on with when you have to carry almost all your requirements in the way of clothes and shelter on your back, and also to learn other methods of

travel than Pullmans and automobiles. Our problem that afternoon was detrainment about sixteen miles up the road in the face of a cavalry attack, which had to be driven off and guard formed for our march to camp several miles distant. Late in the afternoon we came to the camp site, a large flat ground, where the companies were swung out for pitching shelter tents, the art of which we had previously been instructed in. Each two men buttoned their halves of the shelter tent together, a rifle was stuck up for the front pole, a bayonet for the rear, sides pinned to the earth, and your home was built, ready for blankets to be laid. A very pretty sight it was that night under the moon to see the hundreds of little tents, nearly every one with a candle burning in front.

During the week of manoeuvres we arose at 4:45 A. M. while the sun was still a long way from reaching the horizon, and I can imagine many more cheerful occupations than crawling out of a pup tent in semi-darkness into the rain, especially if you'd had a restless night and pushed a shoe out under the canvas to be rewarded with a full cup of water in it, from Heaven. After that experience I used my shoes for a pillow as there were a sufficient number of other ways in which to get cold feet.

Bestowal of the Order of the Barked Shin

Each day we would have about 8-10 miles to cover between camps and often several more if your company was ordered out to protect the flank of the "army" or on patrol duty to locate and determine the strength of the enemy. But we were pretty well hardened by that time and could do "double quick" over some of the roughest sort of country, with the packs pounding our backs, for a surprise flank attack. I remember one day especially clearly. Having just successfully extricated myself from the last barbed wire fence, I was dashing bravely toward the enemy, when I slipped in the swamp, and imprinted a sharp rock on my elbow and shins. These were the only decorations I received during my service.

The Last Day

Songs rang out more freely than ever about the camp fires on the last evening of our manoeuvres, and many good and amusing ones indeed were written during the month. General Wood had given us our last lecture, a beautiful moon shone down at last through the trees of the camp ground, where after our several days of rain, most of us had improved the rocks under our beds by the purchase of straw from a nearby farmer and we were thinking of our discharge on the morrow. It came and we broke camp extra early for the ten-mile hike back to Plattsburg, covered in record time with the help of many



A Street Scene in the Plattsburg Camp

a song. We paraded through the town, crossed the parade ground for a final review by General Wood and were back in the old company street considerably before 10 o'clock. The discharge was quickly accomplished, provided you'd lost no Government property and the certificate awarded and you had finished camp with mingled feelings of joy and regret.

Discipline for a Cause

There was real regret, for with all the hard work, we had had a wonderful experience and many happy times together, and we felt that we had given ourselves and our vacations for something that really counted. We had subjected ourselves for a month to the strictest discipline for the sake of a cause, and I often used to think with a smile of the way we sometimes complain of the discipline in our own organization. After a month at Plattsburg, under the discipline devised for the best good of all and so that every man has a fair and even chance for health, happiness and promotion, it would be pretty natural for us to play the game as we should with fellows, ourselves and the old company. We went up knowing nothing about soldiering and learned enough in a month of intensive training to realize that we were still the veriest beginners.

But I believe every one of us did come away with a conviction that a certain amount of such training would be good for every man, whether we were pacifists or warrists. We felt that the discipline, training, and service to our country, would better imbue every young man with an appreciation of his inheritance, which he should be as ready to defend, if need be, as to accept, with a realization of the broadest meaning and requirements of service, and it would make for and perpetuate a truer democracy through men better trained to appreciate their citizenship and the rights of their fellow men. And isn't it a good way to spend a vacation; in putting yourself in the best of physical condition, in learning something about an intensely interesting and vital subject and withal being quite ready to end the vacation and get back on the job!



Hannan and Vaughn from the Philadelphia House



"COME ON, YOU ENEMY!"
E. B. Craft at Plattsburg

CRUISING ON A BATTLESHIP

How Seven Western Electric Seamen Spent Their Vacation on Board the U. S. S. "Maine"
During the Naval Training Cruise for Civilian Volunteers

By S. W. Murkland



Seaman Murkland

“WHAT do you say, sailor? What do you say? Arise and shine!”

This cheerful morning greeting accompanied by the shrill piping of the bos'un's whistle, the volunteer sailors on the civilian training cruise quickly learned to accept as their alarm clock during their month at sea with the reserve battle-ship fleet of the United States Navy. This

alarm clock had an effective “follow-up” system for those who clung to their hammocks long enough to argue that five o'clock was an unreasonable rising hour even if they did call it “two bells.” Upon the lazy seamen who failed to “arise and shine” and stow their hammocks promptly, there descended a formidable “Dick Dead-Eye” who applied his belaying pin lustily to the unarmored parts of one's hammock and, in extreme cases, inverted the hammock, thereby making it unnecessary to rise at all except from the deck, already awash from the salt water hose preparatory to the morning's scrubbing down.

Among those who came tumbling or were tumbled from their hammocks on board the U. S. S. *Maine* on the morning of August 16, 1916, were Seamen DeVignier, Crawford, Parker and Gisgen of the Engineering Department, Kent of the Patent Department, Noyes of the New York Purchasing Department, and Murkland of the General Accounting Department. With some three hundred other landlubbers disguised as sailors or “gobs” (so the regulars dub themselves), they began from force of habit to speculate on breakfast, although they knew that many tasks occupying two and a half hours must intervene.

Scrubbing Up an Appetite

Fortified, however, by a cup of coffee and a cigarette, each would-be seaman was ready at 5:20 when they “piped sweepers” and 610 bare feet pattered out on quarterdeck and “foc'sle.” To each of the 305 minds which guided them came the idea of getting as close as

possible to the hose, so that when the call came at 5:30 to “turn to” he would have the job of washing down the decks while others struggled with brooms, brushes, mops and “squeegees.” Every man and boy likes to squirt a hose but sweeping and scrubbing is women's work. This, like many other problems on board ship, was solved for us by one of the “gobs” taking charge of the hose and from that position directing the unskilled labor, cautioning them not to knock the brooms, etc., on the deck lest it disturb the officers who were sleeping below.

“Clean ship first, then clean yourself,” had been our first orders; so with decks all scrubbed and “brightwork” shining in the early morning sunlight all hands endeavored to ignore their rapidly growing appetites and lined up on the “foc'sle” for the carefully measured allotment of fresh water. Experience teaches you to utilize your half pail of fresh water in the following order:

1. Brush teeth.
2. Shave.
3. Bathe.
4. Scrub and wash clothes.



Scrubbing Decks at 5:30 A. M.



Fresh Water a Luxury. Line Up for the Morning Half Pail.



Shaving Under the Guns.

The Intricate Duties of the Naval Rookie

Feeling by this time as if we had accomplished a good half day's work and almost expecting the noon whistle to blow, we hear instead the welcome breakfast call, a bugle call which even the untrained musical ear soon masters.

During the hour following breakfast the Civilian Volunteers are left pretty much to their own resources and roam about the ship at will except on the starboard side of the quarterdeck which is held sacred as a sort of private office for the captain and the executive officer. There is some satisfaction in taking our ease during this hour when the fellows back home are scurrying to the office, but the tireless bugler breaks in upon such selfish thoughts with "general quarters" which marks the real beginning of our day's work. Here, after muster, we receive the or-



Scrub and Wash Clothes

ders of the day and, after a brisk hour at "setting up" exercises and manual of arms, are told off to our various "watches" about the ship from lookout in the "fighting top" of the cage mast down to operator on the telephone switchboard below the waterline. The naval rookie has many things to learn about the actual running of a battleship before he is taught anything about the fighting end of the game, and the first week of the cruise was given over to teaching us our way about the ship, the deck duties of signalman, steersman, lookout and leadsman, and the requirements on the "engineering" watches below where they explained to us the mysteries of the engine-room, dynamo, evaporators, steering engines, etc.

In the times not occupied by the regular drills and watches we learned, during this week, such domestic duties

as waiting on the table, washing dishes, laundry work and, in general, acquired the ability to live on board ship and do for ourselves the many things which in our pampered life ashore we have others do for us. To "scrub and wash clothes" so effectively that the white navy uniforms will pass inspection at muster requires no little practice and, as we had to use the deck as a scrubbing board, our first efforts resulted largely in transferring to the clothes line whatever cinders had accumulated on deck since we scrubbed it before breakfast.

The Great Problem of Hammock-Slinging

Hammocks, too, presented their problems. After the first few nights on board, most of the volunteers took advantage of the wonderful run of clear weather which lasted throughout the first three weeks of the cruise and slung their hammocks up on deck. With the growing popularity of this "out-of-door" movement, the choice places from which to swing on the rail, hatches, turrets, lifeboats, gun carriages, etc., were very much in demand, and in the evening at 7:30, when the call for "hammocks" was sounded, the rush to the nettings, where the hammocks are stowed during the day, and thence up on deck resembled the stampede at the opening of new government lands.

Having secured a suitable place, it was no simple proposition to make up your hammock fast, at least for those whose previous experience with knots had been confined to

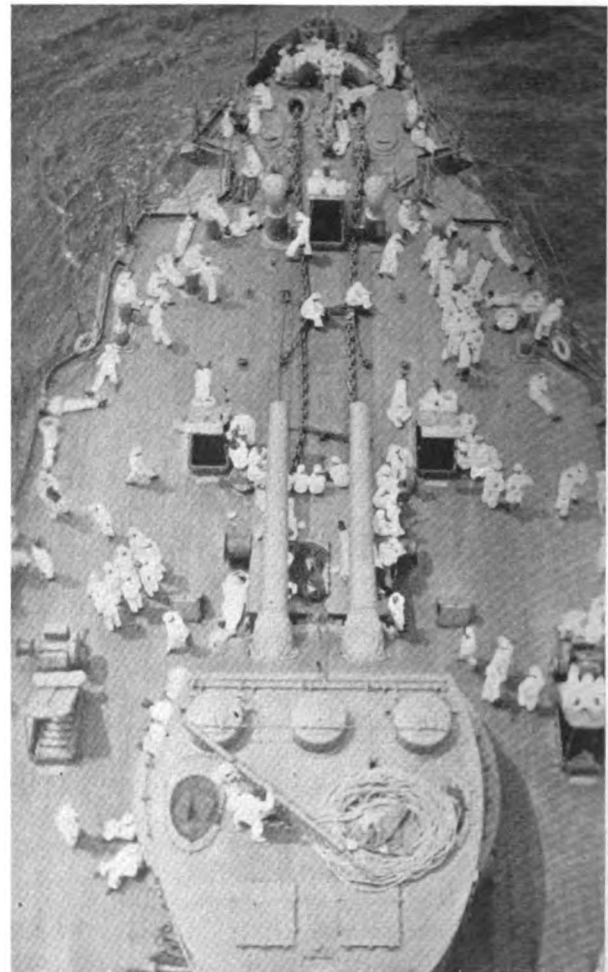

A View of the Foc'sle of the U. S. S. Maine Taken from the Fighting Top

neckties and shoestrings. Many a volunteer who went to sleep proud of the position he had secured found, before morning, that his hammock had slowly sunk to the deck—while with others the descent was not so gradual. Instructors in seamen's knots found ready listeners, but by the time we had mastered the mysteries of square knots, half hitches, running bowlines, etc., and could hang our hammocks with reasonable confidence that reveille would find them in the same position, other means were found to interrupt our night's slumber. Should you not be detailed on some night watch which required you to pace the bridge from 12 to 4, the sleepless bugler would be apt to sound some emergency call at midnight, such as "fire," "collision," "man overboard" or "torpedo defense" at which every one must tumble out of his hammock and go "on the double" to his designated position.

We Search for the "Enemy" Fleet

We had now left our rendezvous off Block Island, where the U. S. S. *Maine*, *Kentucky* and *New Jersey*, bearing the New York contingent, had joined the rest of the reserve fleet consisting of the flagship *Rhode Island*, which carried the Philadelphia volunteers and the *Virginia*, *Louisiana*, *Alabama*, *Illinois* and *Kearsarge* which, with their naval rookies from Portland, Boston, Newport, Norfolk and Charleston, brought the total to about 2,500 civilian volunteers. Three more battleships bearing the "middies"

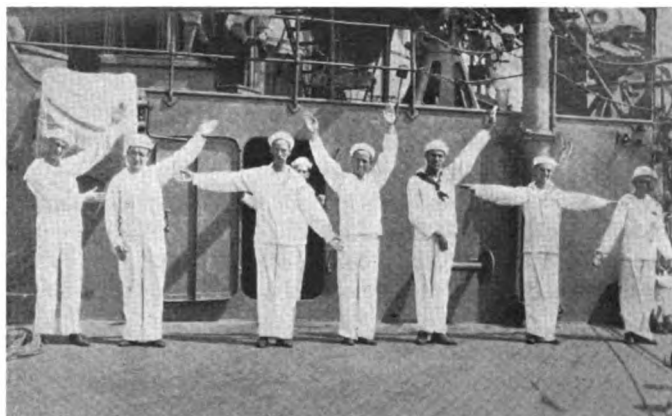

WESTERN
In the Semaphore Language as Spelled by Sailors Noyes, Crawford, DeVignier, Parker, Gisgen, Murkland and Kent.



Winning 3-Inch Gun Crew During Target Practice in Tangier Sound on U. S. S. "Maine." 4 Shots in 43 Seconds, All of Them Hits.



Kent Heaving the Lead.



"Smoking Lamp is Lighted." Crawford Has Learned That This Means Smoking is Permitted.



The Reserve Fleet in Battle Formation

from Annapolis on their summer training cruise and a number of torpedo destroyers, submarines, hydro-aeroplanes, colliers and other auxiliaries completed the defending fleet under Admiral Helm in the war game arranged by the Navy Department. The "enemy," represented by the regular Atlantic squadron under Admiral Mayo, was "somewhere" off the coast and would shortly endeavor to land an invading force on our shores at some point between Maine and Cape Hatteras.

Our job was first to find the enemy and then to destroy his battleships and transports. To the volunteers unacquainted with the rules of the war game it hardly seemed like a sporting proposition to give the enemy all the new first-class fighting ships of the Navy and then send us out on the obsolete battleships of the Reserve Fleet to destroy them, even if our school histories and present pacifists make nothing of such odds. However, as we steamed out to sea in battle formation, our single file of twelve battleships made quite a formidable showing; the torpedo destroyers had already been sent out many miles in all directions to scout for the enemy. As we cruised along the coast, the volunteers were drilled under the conditions which would exist in actual warfare; each man was assigned a definite post at the guns, in the turrets, on the searchlight platforms, or down in the "handling rooms" from which shells and powder are passed up to the men loading the guns; through many drills we learned what

we would have to do at our particular post during an engagement or when expecting a torpedo attack.

We Came, We Saw—But We Did Not Conquer

After searching for the enemy for four days we encountered the fleet early one morning and after the brief but noiseless engagement which followed, we could not help feeling like victorious heroes when the enemy turned and fled. Unfortunately, as we found out later from the official reports of the umpires in the war game, the enemy before fleeing had either sunk or disabled all of our battleships.

In spite of our theoretically helpless condition, we succeeded in making Hampton Roads where our chagrin over having failed to defend our country from the enemy gave place to excitement over the target practice to be held at Tangier Sound during the following week. While at Hampton Roads we were landed at Fortress Monroe and had our first chance to try out on the parade grounds the drills which we had been put through on board ship in the limited space offered by the quarterdeck. Though we could not hope to equal the regularity and precision of the Plattsburg rookies, we all felt somewhat proud of the manner in which the civilian crews from the nine battleships went through their manœuvres and passed in review before Admiral Helm.

Three-Inch Gun Practice

On arriving at Tangier Sound, which is about four hours' run up the Chesapeake Bay from the Capes, the volunteers were tried out for the various positions on the three-inch gun crews. Although in our previous drills we had gone through the motions of loading and firing the guns, we were now preparing to shoot with real powder and shells and in the preliminary try outs the competition was very keen for the choice positions on the gun crews. When the *Maine's* turn came to go on the range, the boat deck on which the three-inch guns are mounted, was cleared of all except the gun crews who, with cotton in their ears, stood more or less nervously at their positions wondering just what would happen to them when the guns



Winning Punt. Rowed by Shovels and Steered by a Broom. Parker is Stroke Shovel.



"Retreat from Swimming"

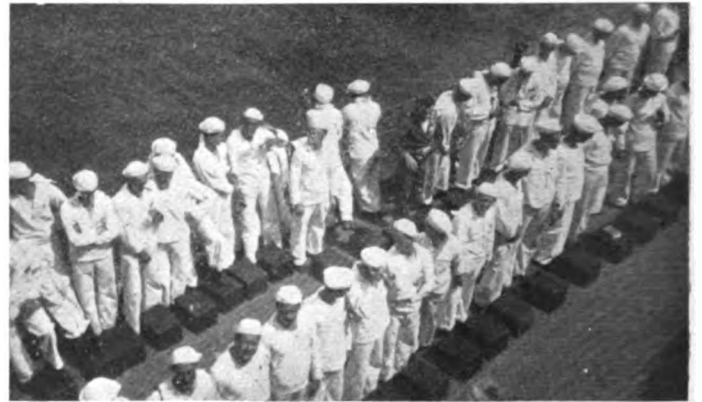

Ditty Box Inspection. The Ditty Box is the Sailor's Bureau, Writing Desk, Humidor and Treasure Chest.

were fired. Each crew was allowed four shots at the floating targets anchored about a mile away. The Western Electric Company was represented on four of the gun crews, including the winning crew which made four hits in forty-three seconds, and the second crew, which made three out of four hits in thirty-nine seconds.

Punting With a Shovel

While at Tangier Sound, as at Block Island, we were taught how to handle the ship's cutters and whaleboats and were put through the small boat manœuvres such as would be used in case of a landing party, the movement of all boats being directed by flag signals. Races were arranged between the boats from the different battleships and, at the end of the week before returning to our home port, a regular water carnival was held with the usual rowing and swimming races. In the punt races standard naval practice was departed from, the crews being provided with shovels instead of oars, and a broom was used to steer by. In the illustration, Parker, who rowed stroke-"shovel" in the winning punt crew, may be made out through the magnifying glass which is furnished free with this issue of the NEWS.

This ended the joint manœuvres of the fleet and each battleship returned to its home port to participate in the motor boat manœuvres, during which the motor boats were drilled in the harbor defense tactics, such as mine sweeping, submarine defense and other patrol duties, the value of which the English have fully demonstrated in the present war. The *Maine*, together with the *Kentucky* and *New Jersey*, anchored off Gravesend Bay. Except for the fortunate few who had specialized in signaling during the

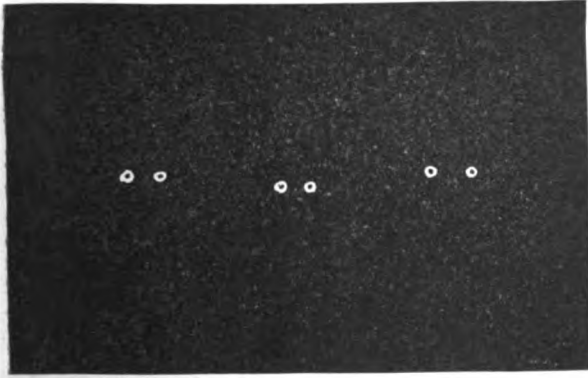

Remarkable radio photograph of Western Electric men on the training cruise aboard U. S. S. Maine. Taken in a coal bunker of the celebrated man-of-war. Readers will note that only the whites of the eyes are visible. The men from left to right are: W. G. Crawford, Apparatus Design Division; S. B. Kent, Patent Department; R. B. DeVignier, Automatic Apparatus Division, all of New York.

cruise and were therefore given assignments on the motor boats, the last week proved somewhat of an anti-climax. Of course, the usual drills were kept up on board ship with occasional landing parties for more extensive drills at Fort Hamilton.

The Lure of the Land

The proximity to New York seemed to stir up a feeling of restlessness, and civilian volunteers who throughout the cruise had discussed enthusiastically questions of gunnery, armament, navigation and signals, would now gather in little groups and torture each other by describing thick steaks smothered in onions, broiled chicken and other mat-

ters culinary. Those who, during the many nights at sea, could hardly wait for taps before tumbling into their hammocks seemed peevish when obliged to tuck themselves in at 9 o'clock with the lights of Coney Island blinking on the port side and the ferris wheel at Midland Beach plainly visible over the starboard rail. The most restless availed themselves of shore leave but the impulse to imitate the proverbial jacky ashore was restrained by the requirements to report back on board ship by 8 o'clock the following morning.

On Saturday, September 9th, reveille sounded at 4:30. Reluctantly we surrendered our "Ditty Box," the only lockable piece of furniture in our outfit, comprising in a few cubic feet the sailor's bureau, writing desk, humidior and general treasure chest in which are stored letters, pictures, candy, tobacco, shoe strings and other valuables. Hammocks and dunnage bags were turned in, uniforms shed and bundled with other effects into our mattress and, clothed once more in our citizens' clothes, we assembled on deck waiting for the ship to disembark us at the Brooklyn Navy Yard, in outward appearance much the same motley crew that started out on the cruise.

In addition to the personal benefits which each volunteer derived from this month at sea under Naval discipline, we had learned at first hand something of the life and duties on board a battleship and the methods of modern Naval warfare. We now knew how, by following up this beginning, we could make ourselves of greater value to the country should the need arise. That such is the intention of most of those who spent their vacations in this way is shown by the number who, before disembarking, enrolled in the Naval Reserve, created by the act of Congress this year, or who volunteered to enlist in the regular Navy in time of war.

Was There a Military Training Camp in California?

There Certainly Was, and Some Western Electric Men Were in It

IT was a busy morning. The NEWS was rushing to press. In came an express package on the run. Twenty-six of the finest story-telling photographs ever taken lay in a box. On top was a letter:

"September's issue of the NEWS to us was most unkind! By observation you will see our names are hard to find!"

(Signed) C. H. BINKLEY, *General*.

J. H. OLSEN, *More General*.

Both of the San Francisco House.

Too, too bad. Through some mistake the NEWS had not heard that some of our Western men had gone to Monterey, the Training Camp on the Pacific Coast; and therefore had not announced it along with the Plattsburg men. Unfortunately the pictures and comments of Messrs. Olsen and Binkley arrived too late to receive real justice in this, our Vacation and Military issue, but some few of the best of the photographs are reproduced this month.



Our Two San Francisco Rookies Working in Construction of Bomb Proof Shelter of Trenches at Monterey, Calif.



J. H. Olsen, "More General," Making Up His Mind to End It All by Turning in His Equipment and Quarter-Master Supplies.

Mrs. Alderman Gilhooley Gets Burned on a Tennis Match

OI have always ruled me childer boy *love*, Missus Cassidy, but Oi till yez ut's har-rud to do afther they git too big fer yez to wallop thim occasionally.

Ut's me Mary Ann Oi'm thinkin' av, Missus Cassidy, her that worruks at the Wistern Illiethricity Company an' is ingaged to Tim O'Shannessey, on the traffic squad. Sure, an' Oi wish he hod her now, Oi do thot—not thot Oi wish the b'y anny bad luck, but ut's thot worrit Oi am over her goin's on, Oi dunno whot's come over the gir-rul at all, at all.

Along about a month ago, Missus Cassidy, she came home late for sooper, an' she siz, siz she: "Oh, maw, gee but Oi've bin hovin' fun. A boonch av us gir-ruls stayed down afther wor-ruk fer Dinnis."

"Oh, yez did all that fer Dinnis, did yez?" Oi sez. "Sure, Oi'd think yez wud fale proud av yerself, an' you ingaged to Tim O'Shannessey, as foine a lad as they is on the force."

"Will," siz she, "what's thot got to do wid ut? This ain't his noight over, so what's the differ'nce if Oi am home late? Oi don't care, anyway, Oi just love Dinnis, an' if Tim O'Shannessey don't like ut he kin lump ut."

"Think shame on yez fer a bowld huzzy," Oi siz. "Worra, worra, thot a gir-rul av moin shud go gallavantin' around wid thir min, an' her promised to the son av her fayther's bist frind."

"Ither min?" siz she, "Whoy, maw, Dinnis is a *spoort*."

"A *spoort*, is ut?" Oi shrieked at her. "Bad cess to ye that tills me to me face yez prayfer a drissed-cop jude to wan av the city's foinest in his uniform."

An' did thot shame her, Missus Cassidy? It did not. She only laffed in me face, an' she siz, "Oh maw," she siz, "yes do git the funniest notions."

"Funny notions?" siz Oi. "Is ut funny to xpiet a gir-rul brung up honest, an' an alderman's daughter, at thot, not to be a disgrace to her fam'ly?" siz Oi. "Git out av me soight, Mary Ann Gilhooley," siz Oi, "befur Oi take a 'funny notion' to break this rollin'-pin over yer hid," siz Oi.

Will, Missus Cassidy, Oi troyed to do me dooty boy the gir-rul widout tillin her fayther, for the auld man's got a hivvy fist whin he's mad. (Sure, ain't it mesilf thot knows ut?) But ivery toime Oi troyed to r'ason wid her she'd only shriek wid lafter, loike she had no shame, at all, at all, an' me thot's bin so careful wid her bringin' oop.

So foinally Oi lost all patience wid the gir-rul an' Oi spoke to Gilhooley. An', Missus Cassidy, wud yez belave ut if the auld fool didn't laff aven worse'n Mary Ann? You'd have thought ut was a big joke to hove a daughter dayvoid av iligince an' dacincy. An' Gilhooley so proud av his fam'ly anner, too, hovin' an ancistor that wance worked thray wakes as groom in the king's stables an' wuz only discharged becaz the hoorses cuddin't get over shoyin' at his face, the poor bastes hovin' bin scared wonet boy a mischavous ape in a circus parade. A livin' image, too, he wuz, av me hoosband, the alderman, Missus Cassidy, as Oi've heard auld Gran'fayther Gilhooley say minny a toime befur he doid, rist his sowl. A proper fam'ly proide the auld gentleman hod, Missus Cassidy. He'd turn over in his grave if he heard what yez are hearin' av his only son laffin' loike á Harry Lauder funnygraft ricord



"Her That Worruks at the Wistern Illiethricity Company."

whin a daycint fayther wud hove been weepin' an' whalin', as the pa-able in the Gud Book used to do, fer a sound whalin' roight thin moight have cured the gir-rul wonet fer all. But instid he stands there an' laffs in me face till Oi cud stand no more av ut.

"All roight, Terence Gilhooley," siz Oi. "If yez think ut's so amusin' to be disgraced boy yer own daughter, laff an' grow fat," siz Oi, "an' mebee afther whoile yez kin git a job wid a circus," siz Oi, "ayther as the fat man," siz Oi, "er to fill a vacancy in the cage wid the laffin' hyenas," siz Oi. "An' failin' thot," siz Oi, "yez kin aisy git in wid the monkeys anny toime," siz Oi.

An' wid thot Oi tuk me hat an' wint to the movies to troy an' fergit ut. An' what shud the bill be, Missus Cassidy, but "Cora av the Cafés, the Story av a Gir-rul Who Prayerferred a Rich Man's Luxuries to a Poor Man's Love. No childer admitted."

Will, Missus Cassidy, all Oi've told yez, bad as ut is, ain't nuthin' at all to the rist. Ut was only the shtart av things. A few days later Mary Ann siz to me: "Maw, Oi can't pay yez me board ontill nixt wake. Oi hod to pay a quarther fer a hawthorne club."

"A quarther fer a hawthorne club, is ut?" siz Oi. "Sure, whoy didn't yez till me yez hod to hove a club an' Oi'd hove let yez tak Gran'fayther Lannigan's blackthorn shillalah thot he cracked the skull av the landlord's agint wid sivinty years ago back on the auld sod. If yez moost hove a club, Alderman Gilhooley's daughter shud hove none but the bist."

"Sure, maw, yez don't onderstand at all, at all," siz Mary Ann. "This is a club fer social porposes."

"Social porposes, is ut?" Oi siz. "Do yez mane to say ut's bitter fer social porposes than yer Gran'fayther Lan-

nigan's? Whoy, thot blackthorn bruk hids at iv'ry social avint in County Kerry fer twinty years whin yer gran'-fayther wuz in his proime, an' scarce a mark on ut to this day, an' ut near to a hoonderd years auld."

"No, no, maw, yez don't git me yit," siz Mary Ann. "This is a club av p'aple, loike the Fir-rust War-rud Dimmyeratic Club, ye know, only ut's called the Hawthorne Club."

"Oh," siz Oi. "But say," siz Oi, "ut was a quarther yez said ut cost, now, wasn't ut? Will, thot didn't sit yez back mootch in yer board mooney."

"No," siz she, "but Oi paid \$8 fer a racket."

"Shades av St. Pathrick's Day," siz Oi, "thot's more than all the b'ys together iver spint fer the Fourth av July befur."

"But Oi didn't spind this fer the Fourth, maw," she siz. "Oi spint it on a racket fer Dinnis."

"Do yez mean to say yez wint on a racket wid thot bum?" Oi daymanded. "An' he lit yez pay fer ut, too, did he? Sure, a foine spoort he is, ain't he now, an' you braggin' him oop so? Yer fayther's goin' to hear av this, me loidy."

Will, Missus Cassidy, an' what do yez think Gilhooley sid when Oi told him? "The gir-rul earns her own money," siz he, "an' if she wants to shpind ut on a little spoort whoy shuddn't she?" siz he. Her own fayther allowin' av her roonin' around an' spinding' her mooney on the little shrimp, Missus Cassidy!

Sure, as yez kin will imagine, Missus Cassidy, ut's near sick Oi wuz over the whole business, but whin Gilhooley wuddn't stand back av me, what wuz Oi to do?

An' there's still worst yit, Missus Cassidy. Oi know yez won't br'athe ut to a livin' sowl er wold hoorses cudn't make me till ut, though goodness knows how soon ut'll be a scandal an' pooblished in ivery pa-aper along wid all our picters—an' me wid me new spongey silk still onmade.

(Come a bit closer, Missus Cassidy.)

Yez know they don't worruk at the Wistern Sathurday afternoons an' Mary Ann giner'ly gits home befur wan. Will, last Sathurday she didn't git home ontill *nearly six*

o'clock an' whin Oi asked her where she'd bin she towld me—(Sh. In yer ear, Missus Cassidy)—She towld me she'd stayed down to the Dinnis *tiniment*. Me ownly daughtther, Missus Cassidy. Oh, worra, worra! An' later Oi heard her till thot bold Flannigan huzzy nixt door some-thin' about there bein' *four love sits* down there, an' anither sit thot *wint to the deuce* intoirely. Oi suppose ut's wan av thim free love colonies they're afther throyin' to git her into, an' me heart's bruk over ut.

Sure, ut's at me wits inds Oi've bin, Missus Cassidy, wid Gilhooley rayfusin' to do his duty as a fayther an' her too big fer me to wallop. But now things has r'ached sich a state, Missus Cassidy, thot Oi've made oop me moind they've got to shtop. Tomorrow Oi'm goin' out to foind this Dinnis tiniment. Ut moost be near the Wistern an' Oi know from Mary Ann's talk ut's on two alleys an' has got a coople av coorts on aitch soide av ut. Oi dunno how far a perfeck loidy ought to go, Missus Cassidy, but Oi do know thot Oi'm goin' to woipe up the floor wid that little spoort, Dinnis, ontill he promises niver to ketch anny more young gir-ruls in his nit.

PHWAT! Here comes me Mary Ann alriddy. Is ut thot late? An' phwat's thot's she swingin' in her hand? A tinnis racket, yez say? An' phwat moight *tinnis* be? A ga-ame? Thot's it, av coorse. Oi say ut now. Ain't ut the auld fool Oi've bin, Missus Cassidy? So Dinnis spills his name wid a *Tay*. Tinnis ut is, to be sure. Whoy the divvil didn't the little mischief till me thot? Gilhooley'll niver lit me hear the ind av this. "A little spoort," do yez moind, Missus Cassidy? An' me thinkin'—och, sure, ut's an auld fool Oi am intoirely."

Well, good-day to yez, Missus Cassidy. This is Tim O'Shannessey's noight, an' Mary Ann will wunt to fix oop a bit befur he comes. Oi'll hurry along over an' till the colleen she naden't hilp git the sooper this avenin'. An' jist to sillybrate the occa-asion, Missus Cassidy, Oi'm goin' to open a can av me dollar-thirty tay, an' ut's mesilf thot's goin' to listen rale careful when Gilhooley sips his sasserful, so thot the nixt toime Oi'll bit yez Oi'll know the sound of tay whin Oi hear ut!



America's Electrical Week Is Coming

Western Electric Men Aid in Spreading the Gospel of Electricity

IT is hard to imagine a better keynote for America's Electrical Week than the conception of the modern Aladdin so tellingly portrayed in Mr. Harold von Schmidt's One-Thousand-Dollar prize winning poster which is reproduced on the News cover this month. How better could the thought of "Do It Electrically" be presented to the public in connection with America's Electrical Week? The Aladdin, of Arabian Nights' fame, could summon, by the mere rubbing of a lamp, an all-powerful slave who would place precious jewels at Aladdin's feet. But the Aladdin of to-day—and any one can be an Aladdin—has merely to touch a button to command Electricity in the forms of Light, Heat and Power—treasures of a practical and utilitarian nature that the Haroun-Al-Raschid never dreamed of.

This design has already been developed by the Society for Electrical Development, of which the Western Electric Company is a member, as a pictorial slogan of the great campaign which is now being conducted in preparation for America's Electrical Week, December 2nd-9th. The design will be used throughout the country. It will be reproduced at least 200,000,000 times—in window displays, street car cards, lithographs, bill posters, newspapers, magazines and even poster stamps. The Genie, Electricity, slave of the little push-button, will be widely advertised.

Men of the Western Electric Company throughout the country are taking an active interest in this work of bringing electricity and electrical devices to the attention of the public. Vice-President Gerard Swope is a member of

the America's Electrical Week executive committee—representing jobbers. And in practically every city of 20,000 population or more the Local Committee for the work has included Western Electric men. Many of the Local Committees have Western Electric men for Chairmen, which means that the direction of the A. E. W. work in their localities is left largely to their enthusiasm.

The Society for Electrical Development has a special service bureau to assist these committee men in making a success of their local campaigns. Already a handbook of helpful suggestions has been issued for electrical men. Specific ways of celebrating the big week of December 2nd-

9th are suggested. By enthusiasm over the slogan "Do It Electrically" and by steady co-operation with electrical dealers, the committee men are striving for even more successful results than were obtained last year by Electrical Prosperity Week.

To bring before the public in the strongest possible manner the manifold advantages of the increasing uses of electricity for light, heat and power is an object which Western Electric men everywhere are seeking to attain. No more practical way of advancing the cause is available than by pitching in and working for the success of America's Electrical Week.



Thirty-five Years With the Western Electric

THE News prints with much pleasure the following letter, written by F. B. Uhrig, western district manager, in anticipation of the thirty-fifth anniversary of his employment by the Company, which will occur on October 15th, together with a reply thereto from Vice-President Swope.

Starting as an office boy in Chicago in 1881 at the age of 14 years, Mr. Uhrig ("Fred" as he is widely and affectionately known to hundreds of Western Electric men and women) has rounded out a term of service seldom equaled in the history of American business. During this period he has successfully filled almost every position in the distributing end of the business; and now while still under 50 years of age, he is wisely seeking a position in the Company that will entail less demands upon his energy and time.

The News joins with Mr. Swope and the great body of employees in wishing Mr. Uhrig a great many more years among us.

Gerard Swope, Vice-President,
Western Electric Company, Inc.,
New York.

My Dear Mr. Swope:

On October 15th next I expect to complete thirty-five years' continuous service as an employee of the Company and to receive the customary service button presented to an employee. This button will carry with it the ultimate recognition any employee can receive for term of service.

The years represented by the five stars have been busy and eventful years for me; the past fifteen years marking the wonderful expansion of the Company's business, have been exceptionally so. To me has fallen the privilege and the pleasure to have a leading part in this work in the West.

The Distributing Houses at St. Louis, Kansas City, Oklahoma City, Dallas, Houston, Denver and Salt Lake, cover a vast stretch of country. The business at all of these houses is, I believe, at present, satisfactory to you.

The duties the work requires are many, the responsibilities are heavy; I anticipate they will be increased many fold in the next few years. I do not believe it is necessary



Fred B. Uhrig

on behalf of the Company nor in justice to myself that I should continue to carry all of the responsibilities. I should like, therefore, with your permission, to be relieved of the management of the Western District and assigned to a position more consistent with the object I have in view.

I cannot accept the service button, about to be presented to me, merely as an emblem of faithful service, nor as a monument to the years that have passed and the deeds that have been accomplished, on the contrary, I must accept it as a passport to the future, entitling me to decreased obligations to the Company and an opportunity

to spend the coming years, which will be the best years of my life, with more freedom and with greater pleasure with my family and my friends.

I wish I could find words adequate to express my appreciation of the policy of the Company that enables me to make this request and for the many, many kind favors I have received from the officials and my fellow employees in the years that have passed; the one I shall always prize most highly came to me about twenty-five years ago. I had cause at that time to discuss with my immediate superior the serious question of leaving the employ of the Company. At the conclusion of our discussion, dear old Mason Jackson took me by the hand and said:

"Fred, you cannot afford to leave the Western Electric."

No truer words were ever spoken. How I wish I could impress them upon the young men of the Company to-day as they were impressed upon me. With the kindest regards, I am,

Yours very truly,

Fred B. Uhrig

"Dear Mr. Uhrig:

I have read your letter of September 9th with great interest.

It is not often that a man completes 35 years of active, responsible and loyal service as yours, and remains as young as you are.

It is quite certain that the Company should make every effort to arrange your work so that you may be relieved of the absences from your family which I know have been many. Fortunately, we can, I believe, so arrange your work that the responsibilities may be less, while the opportunities for usefulness to the Company will still be great; and where we shall continue to have the pleasure of working with you.

I am sure that the officers of the Company will join with me in congratulating you on having completed this long term of successful service, and also in congratulating the Company on the prospect of its continuance for many years to come. Very cordially yours,

Gen. Sweeney

September 18, 1916.

Vice-President."

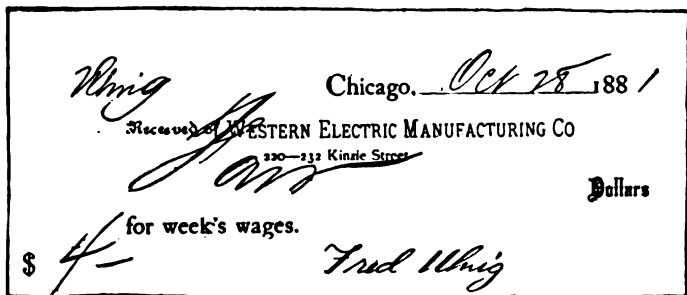

Mr. Uhrig's First Pay Check

Mr. Uhrig early qualified as one of the Company's travelers, but it is particularly since his accession to the position of western district manager in 1907, that his work has necessitated traveling great distances. Fortunately, Mr. Uhrig has kept a record of the mileage covered during this period and he has been good enough to furnish the NEWS with the figures, which are reprinted below:

1907.....	25,932	miles			
1908.....	23,302	"	1913.....	31,151	"
1909.....	25,515	"	1914.....	25,588	"
1910.....	21,710	"	1915.....	19,851	"
1911.....	30,021	"			
1912.....	25,204	"	Total	228,274	miles



The Western Electric and Industrial Preparedness



Underwood & Underwood.

W. S. Gifford, Supervising Director for the Committee on Industrial Preparedness, U. S. Naval Consulting Board.

THE great movement on foot for industrial preparedness in this country is of interest to Western Electric men, not only because we manufacture telephones and telephone switchboards of various types for army and navy use, but because the really big work of the committee on Industrial Preparedness of the Naval Consulting Board of the United States has for

"This committee," says Thomas A. Edison, chairman of the Naval Consulting Board, "itself is responsible for having laid the foundation for a true industrial preparedness in this nation."

A few months ago, the committee for which Mr. Gifford is Supervising Director, began this work in every corner of the country—to mobilize concretely the manufacturers of America and their output against a possible day of need. This involved discovering in full detail just what equipment our fairly large American manufacturers—there are over thirty thousand of them doing a business in excess of one hundred thousand dollars a year—possessed, which might be swung over to supply our army and navy in case this country should go to war. Now the committee knows, after careful inventory and investigation, just what equipment every concern of substantial size in the country could place at the disposal of the government.

The Western Electric Company was, of course, asked for details of its abilities along with the others.

For instance: Through the committee on Industrial Preparedness the government learned that there are some

its supervising director a former assistant secretary of the Western Electric Company, Mr. W. S. Gifford, now chief statistician of the American Telephone and Telegraph Company.

nine million square feet of ground area at Hawthorne, and there are five million more square feet available for expansion. Such details as the carrying capacity of floors per square foot at Hawthorne, a description of our fire protection facilities, details of our water supply—all were placed at the disposal of the government in minute report. In case it ever becomes necessary for the Western Electric Company to turn with might and main to the task of producing telephone equipment and switchboards for military use, the inventory took into account the facilities for feeding employees at our factory. It even asked whether our telephone operators were American citizens.

To be of use to the government in case of an emergency, it is, of course, necessary to be in possession of full knowledge of the accessibility of the plant. Our report showed that all the trunk lines in Chicago, through connection with the belt line which runs through the centre of the

works, serve Hawthorne in the distribution of its output. It is conceivable that the government should want quickly, portable telephones for the marine corps, for use in the field, or lead-covered cable and telephones of various types for the army signal corps, or switchboards for the Navy Department aboard our men-of-war. Thanks to this inventory—the government knows the how and when and where of Hawthorne's abilities in every direction.

In all its investigations the Committee on Industrial Preparedness recognized the great importance of having men in the shops of the nation. Skilled mechanics of all kinds can naturally serve their country best, in the event of war, by sticking to their jobs. Accordingly, the Western Electric Company was asked such questions as "How many skilled laborers are there in your shops?" and even the question "If absolutely necessary, can women replace men and in what numbers?"

AMONG THE ENGINEERS



NEWS OF THE DEPARTMENT FROM NEW YORK AND HAWTHORNE

New York

K. Bungerz, Correspondent

So Dallas thinks we are mournful and that our stuff is highbrow. As to the first, a mournful man would die on this job. As to the second, what does Dallas read in its Browning Club—*The Winning of Barbara Worth*?

A while ago we wrote a little note to E. R. Nolan at Hawthorne, telling him that the August issue of the NEWS would have a scathing comment about the Hawthorne Engineers' lack of contributions. Now see what that little note has done. Good work, Hawthorne; keep it up!

Pretty tough! One of the research branch engineers wrote three letters—two on business and one on fancy correspondence paper. Two envelopes were drab affairs, the third a dream. Upon the dream he pasted twelve cents worth of postage and marked it "Special Delivery." The next day the girl wrote him that sending empty envelopes special delivery was a pretty crude joke. Now he is won-

dering in which of the other two envelopes he stuck that letter.

Hawthorne

PINCHED!

Masek, the manager and third baseman of the engineering playground ball team can take care of most liners, but Old Sol knocked out a sizzler recently that looked too hot for him to play. Consequently, he stole a big lead away from his drafting table, and when nobody was looking, struck out for the basement, thinking that if he could make a hit he might get the shower bath to run for him. It was a base steal, but remember he was far from home.

He was just getting used to the shower bath's drop when one of Pat McGlynn's fly cops put him out in a pinch play. His boss confirmed the decision by calling him out on the carpet and proceeding to bawl him out for striking. So now the score stands one strike and one bawl.

But the question is: Why was McGlynn's cop visiting the "cooler" that hot afternoon? Surely, none of Pat's men would steal a bath!

Foreign Notes

E. C. Richardson, our manager at Milan, sailed on September 16th to return to Italy after a stay in this country. Mr. Richardson was married on September 4th to Miss May Alice Sherman, of Vermont.

H. M. Pease, Assistant Manager of our London house, is in New York on a few months' visit. This is his second trip to America since his appointment to our European organization. Mr. Pease expects to visit Hawthorne within the near future.



H. M. Pease, Asst. Manager,
London



E. C. Richardson Who Has
Returned to Milan

OUR OWN "WAR NEWS"

A "POEM" sent in by one of the Western Electric soldiers and purporting to describe Texas contains a stanza which runs:

"The rattlesnake bites you, the scorpion stings,
The mosquito delights you with his buzzing wings;
The sand-burs prevail, and so do the ants,
And those who sit down need half-soles on their pants."

To help our boys meet such strenuous conditions, the men and women of departments 6338 and 6339, Hawthorne, sent the Western Electric members of Company K, 2d Regiment, bags containing needles, threads, buttons, pins, etc., that come in very handy to the man who must be his own seamstress. Special packages, containing a pipe and tobacco, were included for each man. Besides these "necessities" of life, candy, chewing gum and other luxuries were included.

The picture accompanying this article shows some of the boys opening their packages. The photograph was sent by J. P. Crowley who writes:

"Dear Mr. Bergquist:

"This is a holiday at the camp, as we just received some parcels from the boys and girls at Hawthorne. We had a lot of fun showing our presents and dividing our candy and cigars with the other boys who were not of the Western Electric Company. Everybody was happy.

"We enjoyed your article in the WESTERN ELECTRIC NEWS.

"Yours truly,

"J. P. Crowley."



Hawthorne Boys on the Border Opening Parcels from Friends in the Company at Home

The following is another letter received from Installer C. N. Burlew, now Private Burlew, of Company E, 22d Engineers:

"Mr. H. Warnecke.
"Dear Sir:

"I wish through you to thank the Western Electric Company for the interest it has shown in its employees on duty here at the border and elsewhere. The boys here join me in this.

"I received this month's copy of the News, which I found very interesting.

"Yours truly,

"C. N. Burlew."



Changes in Organization

C. H. MINOR has been transferred to New York, with the title of (A-B) Sales Manager, reporting to Mr. Street.

C. S. Voorhees, with the title of Assistant (A-B) Sales Manager, now reports to Mr. Minor.

P. L. Thompson, Advertising Manager, now reports to Mr. Rockafellow.

F. B. Gleason has been transferred to Atlanta, with the title of Assistant District Manager.

J. W. Tabb, formerly in the Richmond Sales Department, has been appointed Manager of the Buffalo store.

G. Sturcken, formerly Acting Manager, has resumed the duties of Stores Manager, Buffalo.



C. H. Minor



F. B. Gleason



C. S. Voorhees



J. W. Tabb

SOME OF OUR OFFICIALS AT PLAY



VICE-PRES. HALLIGAN STARTS
"THE GREAT SUMMER DRIVE"



R.H. GREGORY, COMPTROLLER AND HIS
CHILDREN IN MASSACHUSETTS



C.E. SCRIBNER CHIEF ENGINEER AND HIS
NEW STANLEY STEAMER IN VERMONT.



VICE-PRES. SALT ON A HIKE IN
NORTHERN NEW ENGLAND.

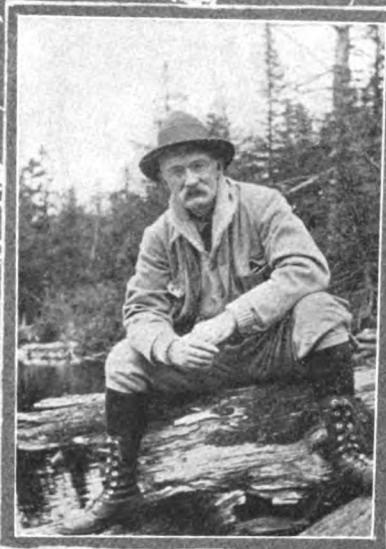

PRESIDENT THAYER AT CAMP IN MAINE.



VICE-PRES. SWOPE AND ONE OF HIS
BOYS ON THE NANTUCKET SHORE.



TREASURER JOHNSTON MOTORING IN NEW ENGLAND.

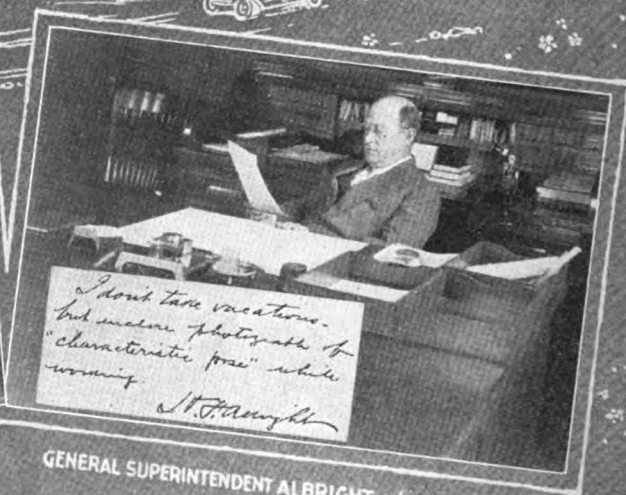

*I don't take vacations,
but make photographs of
"characteristic poses" while
working.*
H. J. Albright

GENERAL SUPERINTENDENT ALBRIGHT - (AT PLAY)

HOW WESTERN ELECTRIC VACATIONS ARE SPENT



H. E. SHREEVE — THE ONE WITH THE LARGE BOWIE KNIFE ON THE LEFT HIP. AND MR. JEWETT ON VACATION IN MAINE.



J. W. HARRIS, DRESSED UP IN HIS MOOSE CLOTHES AND HIS GUIDE WHO KNOWS WHERE THE MOOSE LIVE.



ASST. CHIEF ENGINEER JEWETT IN THE MAINE WILDERNESS: PRESUMABLY WASHING CLOTHES.



YES, IT'S HIS WIFE! AND SEE! HE CAN SUPPORT HER. — W. D. LINDSEY —, ADV. DEPT., ON THE JERSEY BEACH.



ASST. GEN. SALES MGR. EDDIE ROCKAFELLOW HARD AT WORK AT HOT SPRINGS, VA.



WHAT WE CALL A GOOD HUNTING PHOTOGRAPH OBSERVE THE GUN, HAT, JACKET, BOOTS AND DUCKS WHICH SURROUND S. A. SEABOLT OF THE ENGINEERING DEPT., NEW YORK.



ROSS SMITH, ACCOUNTING DEPT., READY FOR A HIKE AT PLATTSBURGH.



WHERE W. A. WOLFF, ADV. DEPT., ☼ SUMMERED. PHOTO BY HIMSELF.

The Double Prize Winning Photograph

M. A. Curran and W. F. Gibbs, Winners in NEWS Vacation Photograph Contest

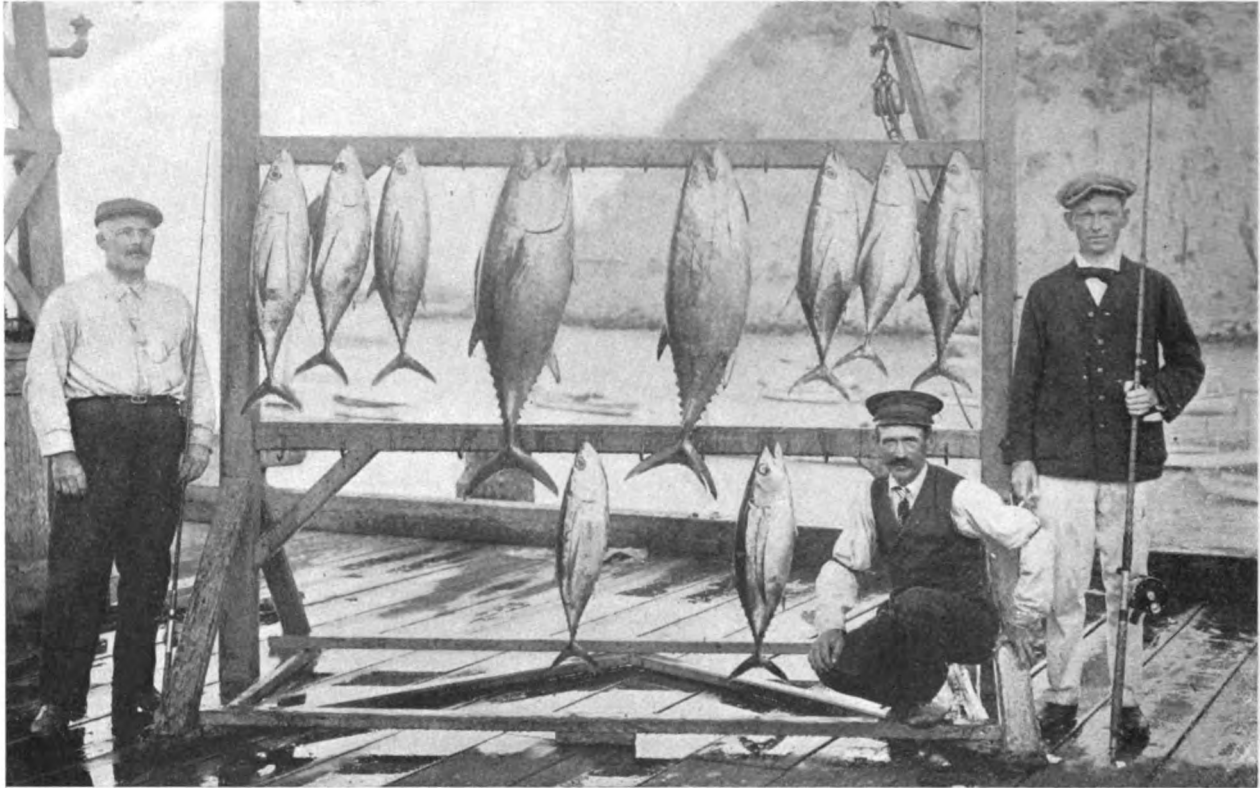

At the right, M. A. Curran, General Credit Manager. At the left, W. F. Gibbs, Credit Manager at Los Angeles. Between Them Two of the Finest Specimens of Fishhood Ever Caught—A 56¼ lb. and a 55¼ lb. Blue Tuna, Together With Other Fish.

THE prize for the photograph of the best catch of fish or game by a Western Electric employee, offered in the News Vacation Contest, has been doubled by the judges and awarded to Messrs. Curran and Gibbs together for the picture of their remarkable tuna catch. The winners are thereby each entitled to a prize, choice of which was detailed in last month's News.

This interesting catch of Messrs. Curran and Gibbs is described in *The Islander*, published at Avalon, Catalina Island, Cal., near which the haul was made:

"While fishing near Long Point Mr. M. A. Curran, of New York, brought to gaff a blue fin tuna weighing 56¼ pounds and has since been made an honorary member of the Tuna Club. For an albacore taken on light tackle Mr. Curran also won a light tackle button.

"His fishing partner, Mr. W. F. Gibbs, of Los Angeles, landed a blue fin weighing 55¾ pounds on the regular tackle and both the anglers have taken other varieties on light tackle as well as tuna outfits."

The NEWS congratulates Messrs. Curran and Gibbs, bestows upon them hereby the title of Izaak Waltons of the Company, and awaits with interest any one in this great organization of ours who thinks he can equal or surpass the catch reproduced above!

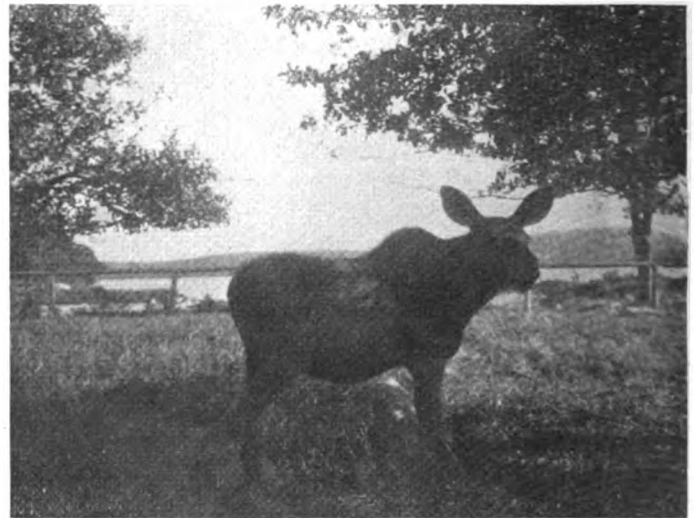

J. W. HARRIS' ENTRY LOSES OUT

This Magnificent Specimen of a Young Moose, Entered by the Head of Our Chemical Laboratory in the Hope of Landing a Prize, Caused the Judges of the Vacation Contest More Trouble Than Any Other Entry. Some Thought Well of It Until the Rumor Drifted Down From Maine That Harris Has a Regular Farm Where He Raises These Things. According to the Report, Harris Catches 'Em When Quite Young and Brings Them Up on the Farm Till They Acquire a Respectable Growth of Horn. It is Then, and Only Then, According to the Rumor, That Harris Shoots Moose. It is Said—Mark You, the NEWS Does Not Vouch for This Statement—That It is by This Method That Harris Keeps His Office in Moose-Heads!

The Prize-Winning Story

The White Streaks

By C. H. Parker, Research Division, Engineering Department, New York

DURING the recent "War Game" the civilian volunteers on the naval training cruise were given a taste of real war conditions in the Navy. One condition was the vigilant lookout kept especially at night for any object that might be seen. During foggy weather or on dark nights each ship trails a fog spar over her stern so that the next ship in line can see it and keep her proper position. The spar is about 400 yards from the towing ship, and the following ship keeps about 50 yards back of the spar.

I was on the forecastle watch one night during the "War Game," and it was my duty to report any great change in the distance to the fog spar to the officer on the bridge. The ships were rushing along at full speed, for we had just received news of the location of the enemy

and were trying to head him off. All was quiet on the ship except for the throb of the engines and the rush of the waters against the prow. The first hour had passed slowly and uneventfully, when suddenly I saw four white streaks heading through the water toward the ship. To say that I was startled was to put it very mildly, as they had about the shape and speed of a torpedo. But before I could turn around, they reached the ship and turned toward the bow. Then one *jumped* out of water, and I knew what they were—a school of porpoises!

For over an hour they played around the bow of the ship, and it was a pretty sight to watch. The phosphorescence in the water outlined all their movements, and made each quick turn and jump look like a flash of silver. They kept just outside of the bow wave, and seemed to play hide and seek with each other around the ram of the ship. Four more came up and joined them after they had been there for a short time, and made the water look like a sea of liquid green fire. Suddenly there was a flash and a sparkle of phosphorescent drops and I saw them no more.



A Trio of Special Contest Entries

Some General Department Boys of the First, Second and Third Generations



Mr. J. W. Johnston Enters This Picture as Evidence That He is the Youngest Grandfather in the Company



Mr. Street Enters His Son as the Greatest Three Year Old Baseball Player in the Country—a Chip of the Old Block



Mr. Swope Enters His Picture in a Contest Open to Western Electric Men With Four or More Sons

Mr. Sidley's Vacation

Vice-President Sidley was spending his vacation in Montana, far, far from the NEWS' printing office, and was therefore unable to get us a vacation picture in time for this issue. But some interesting photographs are coming, as well as a vacation story from Mr. Sidley's pen.

Telephone Men Visit Hawthorne

N. T. Guernsey, General Counsel of the American Telephone & Telegraph Company; E. S. Wilson, General Counsel of the Chicago Telephone Company; E. S. Mack, Attorney for the Wisconsin Telephone Company, and Judge John I. Dille visited Hawthorne on September 1st and were shown through our plant.



Marie Iselli, Hawthorne (left) and Anna De Marco (center), of Clinton St., Sawing Wood on Vacation



"He Was So Big, Thayer!"
Mr. Salt Telling Mr. Thayer About That Fish



Mr. McQuarrie and Mr. Ed. Holmes at Martha's Vineyard

Vacation Snap Shots



Misses McKean and Hannigan, Order Entering Dept., Chicago, Impersonating Hans and Gretel While Vacationing

According to S. M. Wilson, Dept. 6961, Hawthorne, You Can Turn a Flivver Into a Pullman for Vacation—If You Follow the Example on the Right



Misses Karas and Kopecky, Order Entering Dept., Chicago, Picked Cherries on Vacation



On the Militia Naval Cruise; Clarence O'Neil, Adv. Dept., 2nd from right, 1st Row

Our Cub Nearly Reports Department 6113's Picnic

DEPARTMENT 6113, Hawthorne, held a picnic at Dellwood Park, near Joliet, August 19th. That fact is clear and definite. Besides the accompanying photograph of the picnickers furnishes documentary evidence in support of it. But after our cub reporter had that much written down, a couple of the enthusiastic participants dropped in to tell him the details of the glad doings. By the time their enthusiasm had ceased to boil over, our scribe's small blaze of inspiration had been put out entirely and he was so completely bewildered by the whirlwind of happenings that he didn't know how to proceed. Luckily an amused stenographer took a record of the whole affair, so we have the facts. See if you can unravel them:

The Man Visitor: Say, you're going to give us a write-up about our picnic, I suppose?

The Girl Visitor: Of course he is. He looks like an awfully nice man and I'm sure he'll do that much for me—I mean for us. Won't you? (Gets the range on our cub with a pair of 42-centimeter baby-blue eyes. The first shot scatters his wits completely.)

Our Cub: Why, yes. Sure. Of course. Er—how was everything?

The Man: Fine! Great! Say, that was some feed they set in front of us down there, take it from me! Miss Sponholz, who was head of the refreshments committee, certainly does know how to order a good meal. This one was so good that a lot of us fellows wanted to marry the cook, until we found out she was a man.

The Girl: Yes, that's just like you men. Your hearts are all stomachs. I don't suppose you bought even one ticket for that "beautiful silk umbrella," just because you couldn't eat it.

The Man: Couldn't, eh? Hm! Many's the umbrella I've put down. (To our cub) Say, that was a regular bunco game, but it helped fill up "Speed" Gilbert's treasury which paid for the doings, so I guess it was all right. You see, on the way out our pretty girls went around and sold us fellows raffle tickets on what they said was "as fine a little umbrella as you'd care to see." Well, so it was, too, for that matter. A chance cost a fellow any place from a penny to 50 cents, according to how unlucky he was. Most of us took several chances. A \$5 umbrella is well worth drawing. Somebody slipped up on the decimal point in this case though, for when R. N. Meyers gave out the "prize" it proved to be a toy Japanese umbrella, price \$0.05 at any jitney store.



The Girl: Aren't the men easy, though? And, oh say, do you know Fanny?

Our Cub: Why-er-yes-er-that is do you mean the little blonde out in—

The Girl: Ah ha! You've proved it. You gave yourself away that time. You see, this one is a man—"Pop" Fanny. Pop doesn't mean "daddy" in this case though. It means just pop—or maybe popular, because he spent most of the afternoon and all of a week's wages buying the girls all the many colored temperance drinks down there. My "tummy" doesn't feel right yet. "Look not upon the wine when it is red," but oh you blue pop!

The Man: Yep. We had all kinds of pop bottles to throw at the umpire in our ball game. Great game it was! The teams were evenly matched except that O'Donnell's boys got 14 more runs than the others, who got none at all. Besides the ball game we had a men's race, which Vitovec won, and a married women's race, which went to Mrs. J. Kaubek. Then, by special request, Prine and Hanley made a long run in their screaming comedy: "Watch My Smoke," a two-man race for a box of cigarettes. Prine pulled off his shoes and pulled down the prize. He pulled on the shoes again though before the dance in the evening, and then between dances he pulled on the cigarettes.

The Girl: But aren't you going to tell him about the girls' race and how "Slim" Morley spent the rest of the day nailing on the high heels that came loose?

The Man: And how all the fellows, married and single, lined up to watch the finish—all except poor Jennings, who had to act as starter? Yes, I was going to tell him about that, but I thought I'd give you a chance to beat it first.

The Girl: Good-night! Well then, I guess I'd better go now while the going is good.

Apparently the stenographer thought it wise to follow her example, for the account ends right there. Maybe you can get a story out of it for yourself.

AIN'T IT SO, FRITZ?



Results of New Customers and New Business Contest for July and Seven Months of 1916

SALESMAN SECURING LARGEST NUMBER OF NEW CUSTOMERS DURING JULY

A. T. SLACK, Denver

SALESMEN SECURING HIGHEST NUMBER OF POINTS FOR SALES TO NEW CUSTOMERS FOR PERIOD ENDING JULY 31ST

B. P. Martinson, New York, 601

J. R. Stuard, Philadelphia, 327

C. C. Caven, San Francisco, 276

Western Electric News

PUBLISHED
MONTHLY

FOR THE
EMPLOYEES

BY THE WESTERN ELECTRIC COMPANY, INCORPORATED

H. B. Thayer, *President*
W. P. Sidley, *Vice-President*
and *General Counsel*
Gerard Swope, *Vice-President*
and *General Sales Manager*
J. W. Johnston, *Treasurer*
G. C. Pratt, *Secretary*

H. A. Halligan, *Vice-President*
A. L. Salt, *Vice-President*
and *Gen. Purchasing Agt.*
H. F. Albright, *General*
Superintendent
C. E. Scribner, *Chief Engineer*
R. H. Gregory, *Comptroller*

Office of publication and address of President, Secretary, and Treasurer, 195 Broadway, New York City.

BOARD OF EDITORS

P. L. Thomson, *Editor-in-Chief*

P. K. Condict E. C. Bstep S. W. Murkland P. M. Rainey
W. F. Hendry F. J. Holdsworth H. D. Agnew
John Colter Reed Calvin

Subscription: \$1.50 per year, except to employees of the Western Electric Company, to whom copies are furnished free of charge.

All communications and contributions should be addressed to WESTERN ELECTRIC NEWS, 195 BROADWAY, NEW YORK.

Matter intended for any given issue must reach New York not later than the 12th of the preceding month.

VOLUME V OCTOBER, 1916 NUMBER 8

PUTTING A PRICE ON EXPERIENCE

H. L. GRANT, sales manager at Chicago, was recently asked to speak at a luncheon of employees of members of the Chicago Association of Commerce.

"Talk on 'Getting Ahead,'" they had suggested.

A man could talk a long while on that subject and do nothing but spin generalities. But Mr. Grant told his listeners specifically what he thought made a man valuable in to-day's business world.

"Anyone who has had experience in employing men," said he, "will tell you that a large percentage of applicants have records for dabbling in many kinds of work. Two years with an insurance company, a year with a mail-order house, six months with a steel company and six more in a wholesale grocery—is frequently the sort of record submitted by a man who wants to enter the electrical business.

"One day you are told by applicants that the banking business no longer offers opportunities, the next day that a man cannot succeed in the hardware business without a pull, and the third day the railroads hold the young man down.

"After interviewing applicants for a few months we discover the altogether amazing conditions that every line of business in Chicago, great and small, is clogged with men at the top who block the way, is honey-combed with relatives, or in other manner is so conducted that the ambitious young man has no opportunity to get ahead.

"Now, what is the answer? In my brief business experience I have come to the conclusion that it does not make much difference what line of business you or I go into. All lines of business are hard. But the thing that does count in our advancement—granting

that we have ability and certain other characteristics—the big variable that counts more than anything else, is our experience in our own particular business. Especially in these days of specialization in engineering, manufacturing, distributing, and in every line, it is doubly necessary that we select definitely the line of business we intend to follow and then dedicate ourselves to that business."

What makes men valuable to the Western Electric Company is primarily how much they know about the nature of this intricate business of ours. Did you ever stop to think that when you have worked for five years in this business, your experience is in reality your capital? It is on that capital as an investment that we draw interest in the form of salary. When our five years have become ten or fifteen or twenty, we've piled up that much more capital and, of course, it brings us in more interest.

And so it is true that the men who have been longest with the business are usually the men who know the most about the business—*this business*, not some other—and in the Western Electric Company they are the men who have won their way to the top—*i. e.*, they are the men who direct our business. If you don't believe it, watch the new "Roll of Honor" page in the NEWS and see who have the service buttons with the greatest number of stars.

ARE YOU A CHAMPION?

THOSE of us of the Western Electric who are true Knights of the Niblick, Minions of the Mashee, or Devotees of the Driver—or whatever you please to call golf enthusiasts—will mark with especial interest that the Western has two real golf champions in its midst. Mr. Groves, Stores Manager at Des Moines, by winning the State Championship of Iowa, and Mr. Rautenbush, of our Chicago office, by carrying off first honors in the great match of his city, have given our week-end tee-brushers something to talk about—and something to live up to if they can!

Where are our other champions? The June NEWS told of William Hallas, Hawthorne's national wrestling champion. Is there a Norris Williams in our midst who has harvested a tennis title; a champion of the water, ring, track or field? Do you know any Western Electric man who has excelled in other things than our business? The NEWS wants his picture and pedigree, if you do.

GROWTH

JUST a year ago September 1st there were 14,908 employees of the Western Electric Company. On the 1st of September this year we passed the 23,000-mark—23,004, to be exact.

Occupational Diseases

NO. 13—"YELLOW" or "BUCK" FEVER. An illusion that leads the victim to imagine that he can sidestep his responsibility by passing the buck to somebody else. Don't try to shift your job onto the other fellow. If you'd rather not handle it, the Company prefers to pick out a man, itself, for the work.

HEARD IN THE SHOPS

ACTIVITIES OF THE MANUFACTURING DEPARTMENT AT HAWTHORNE

Who's Who at Hawthorne



Who gets them when they first blow in from Hickville Polytech, "rah-rah" from shoes up to the chin, half done above the neck? Who takes the swelling from their domes and gently breaks the news that we can't use "nobody homes" for filling big men's shoes? Who makes each write his history out?—"Wed? Single? Hope to be? D'Your grandad ever have the gout?" Good-night and hully gee! Who used to set the piece-work rates

for the Cable-Rubber clan? Yo-ho, now. All together, mates: That Harry Agnew man.

This Fish Story Is Sworn To

When Mark W. Villim, on leave of absence, recently sent friends in the layouts department a picture postal of the Ludington, Mich., court-

house and a statement that he was "enjoying the rough life" the recipients naturally had an uneasy feeling that he might be finding his vacation somewhat confining. Consequently when he brought back the accompanying photograph and others of a similar nature, with appropriate stories, they didn't know what to think. Wherefore the aforesaid Mark W. Villim, being



to us personally known, did appear before us on the 9th day of September, A.D. 1916, and being duly sworn, de-

posed as follows, viz., to wit: That during his sojourn of eighty (80) days at Hamlin Lake, Mich., he did with no other weapons than a hook and line ensnare, hook, catch or otherwise captivate one thousand and forty-eight (1048) fish, said fish having been taken from the water by said Villim, deponent, while in their wild state, and by him removed from the hook unaided and unarmed. Deponent doth further aver that the complete list of said fish is fully and truthfully set forth as follows:

Kind	Wgt. in lbs.	Number.
Pickereel	2 to 8	168
Silver Bass	1/2 to 1 1/4	622
Rock Bass	1/2 to 1	190
Pike	2 to 3	4
Black Bass	2 to 4	13
Blue Gills	1/2 to 1	47
Sheepshead*	4 to 6	3
Dogfish*	9 1/2	1
Total		1,048

* Not edible.

Deponent herein further swears that numerous small fish were by him replaced in the water after capture and that he did furthermore catch vast numbers of perch, of which he kept no count.

In token whereof said Mark W. Villim, deponent, doth hereunto set his hand and seal, etc., etc.

So there you have the oath and there you have the picture. Make the most of them.

The Clock Strikes Back

I'm just a big round time-clock,
I stand against the wall.
I get everybody's number
That passes through the hall,
And every morning, noon and night
Long lines of humans cruel
Punch up my face,
While I stand there
And take it like a fool.
But here is where I get revenge:
When anyone is late,
I mark it down in black and white,
I am the hand of fate.
And then when Raise Day comes around
I have my little laugh;
The saddened visages I see
Reduce my trials by half.

—M. A. D., Dept. 6447.

What Garden Were the Onions From, Mary?

There ought to be a law to protect our great vocalists. When the phonograph companies can their voices for future consumption that is bad enough, but the well known bounds were certainly passed when Chopard recently advertised on his menu "Calve's liver, smothered in onions."

AROUND THE CIRCUIT

GOSSIP GATHERED BY THE DISTRIBUTING HOUSE CORRESPONDENTS

Omaha

M. A. Buehler, Correspondent



Wallace K. Groves, Stores Manager of the Western at Des Moines, Iowa, has become golf champion of the State of Iowa. Although Mr. Groves has played golf for many years, it is his first big championship. He played remarkable golf during the

State Tourney, beating his opponent in a cleanly contested match, four up and three to play, and establishing a record of 72 for the 18-hole course.

Richmond

W. Lancaster, Correspondent

Frank Van Gilluwe, of the Nela Specialties Division, National Lamp Works, has been appointed successor to J. W. Tabb, now Manager of our Buffalo store.

We introduce Van Gilluwe
To our old friends most formally;
But what's the use? Not any man
Is formal with an energetic Van—
It's Van this and Van that
The moment that he tips his hat;
Not too familiar, understand;
It's more because they like the man.

Beginning November 1st we will occupy a more modern and capacious building, one that is in keeping with our growing business. Our address still will be 6th and Cary Streets, for our new building is just across the street from our present location.

New York

R. E. Webster, Correspondent

CAN YOU BEAT IT?

A man and his wife recently came into our 40th Street Store, and after looking around a few seconds, pointed to a dishwasher and said:

"That's as fine a clothes washer as we have ever used. The only trouble is the clothes don't move. Every 5 or 6 minutes you have to put them in a different position."

Upon inquiring, the salesman learned that the machine had been sold to them at a charity bazaar as a "Washing

Machine" and had been in constant use ever since as a clothes-washer! They had never looked at the label and had gone on in blissful ignorance.

After having our Washer and Wringer thoroughly demonstrated, and laughing at their own error, they left, vowing to purchase our *real* Washing Machine as soon as their dealer could install one.

D. D.

San Francisco

C. L. Huyck, Correspondent

This is a portion of our San Francisco, Oakland and Emeryville delegations to the San Francisco Preparedness Parade. The parade was particularly noteworthy in that it contained about 11% of the listed city population, as compared with New York's 2%, and Chicago's 5%.



The straw-hatted field-marshal in the foreground is our Pacific Coast Manager, Mr. Leggett.

The parade moved on schedule time throughout, the various divisions falling in and proceeding without a hitch to their appointed places of disbandment. This was due to an ingenious method of timing and tracing by telephone stations.

Dallas

O. T. Hazelton, Correspondent

Now comes a learned man, yea a college professor with half the alphabet and many titles after his name, who says that our good word Bonus (which means "a good thing") is not good Latin. It is slang. We recommend that the editors ask our New York and Atlanta correspondents who cover the extremes in high-brow stuff and slang respectively to get together and see how many more such dead ones they can dig up.

As our correspondent, O. T. Hazelton, a Sergeant in Battery "A" 1st F. A. Texas (Uncle Sam's largest Battery of light Field Artillery), was returning from service on the border at Ft. Ringgold, Texas, he had the pleasure of meeting a number of Hawthorne men out of the famous

Western Electric outfit "Co. K, 2nd Illinois Infantry"—famous for the number (thirty-three) of W. E. men on its roll.



The accompanying snapshot caught them as they were lined up for retreat on Sunday evening, September 3rd, in front of the Army Y. M. C. A. building, which they have been using as temporary quarters since receiving orders to entrain for the North. No such comforts were to be had by the Dallas correspondent while stationed on the same camp site a month previous—he was lucky to get a tent shelter and government shoes to ward off the Texas gumbo when it rained.



"When Dallas meets Hawthorne on the border" is illustrated by the above group. Sergeant Hazelton of Dallas is third from left in front row. Others are Lieut. Nelson, Sergeants Barden, Will and Engleman, Corporals Valence and Reynold, Privates Crowley, Johnson, Madigan, and Simon, all of Hawthorne.

Chicago

H. L. Grant, Correspondent

RIGHT SHOULDER ARMS. HIP!!

Private M. Filetti, now of the Second Illinois Infantry, but formerly of our Associate Pricing Department, was one of the boosters on a recent border hike to Leon Springs. It seems that when the Illinois boys began to drop out of line on account of the heat, Filetti suggested to his captain that if four singers could be found in the company, he would furnish the instrumental accompaniment in the form of a mouth organ. The quartet was immediately organized and placed at the head of the company and 'tis said that the music made the men forget all about their pedal troubles so that during the remainder of the march the company made an excellent record, not a man falling out for eighteen miles.

RAUTENBUSH WINS CHICAGO CITY GOLF CHAMPIONSHIP



William Rautenbush

William Rautenbush, of our Associate Service Department, won permanent possession of the Chicago City championship cup this Fall and at the same time established new records for one, two, three and four rounds on the course at Jackson Park. The events were important in local golfdom the galleries running from 1,000 to 1,500.

Bogey at Jackson Park is 80. Par 71. Rautenbush's four rounds were 75, 75, 72 and 66—total, 288. His score of 66 establishes a new record for the course, the former record of 68 having been made by Chic Evans.

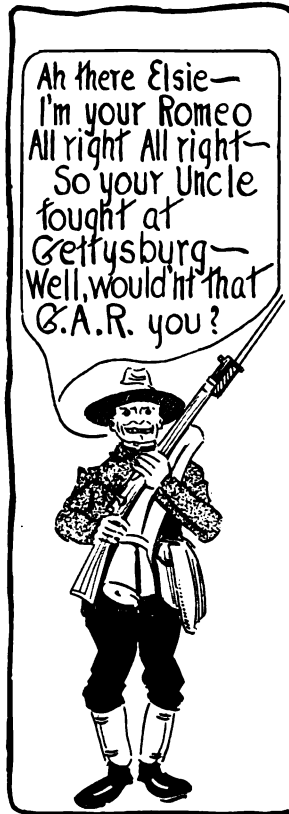

Ah there Elsie—
I'm your Romeo
All right All right—
So your Uncle
fought at
Gettysburg—
Well, wouldn't that
G.A.R. you?

Sergt. G. S. Pritchard, 1st Illinois Cavalry, submits the following letter received by his troupe in Texas. The letter was not directed to him personally and Pritchard in fact side steps. We publish it in order to encourage enlistment:

"I want a soldier to write to and to worry over and I haven't any. I have a grandfather and two uncles who fought at Gettysburg, so I want a sweetheart who is a soldier and I am coming begging for one. Will you help me find HIM?

He need not be an Apollo, but just a nice gentle boy who may be as lonesome as I. He must not write to any other girl. I hate them all. Cats!

As I am a brunette, I naturally prefer a blonde about five feet, eight inches tall, not too fat, but I guess you don't allow them in the army, anyway.

I am not trying to flirt and hope this is in confidence, with regards to my name outside of the ONE BOY.

"ELSIE."

The following golf yarn was published in the Chicago Evening Post and is vouched for by Rollo C. Kearsley, of the Sales Department:

"William Gierstein, John Byrne and Rollo Kearsley, three honorable men—that is, if there are any honorable men who are members of Glen Oak—were playing the fifth hole of the Glen Oak course. Kearsley and Byrne had pitched onto the green and were standing near it when Gierstein, who had topped his tee shot, pitched over the

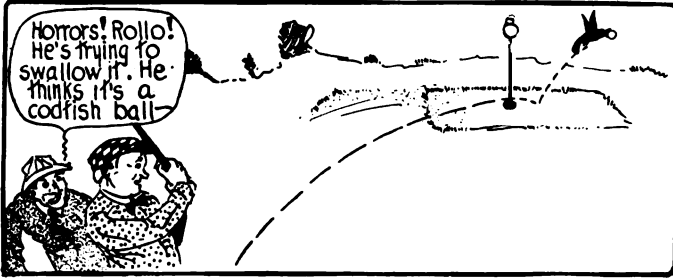

hazard onto the green, and as his ball rolled across the green a large crow swooped down and, without stopping, picked up Gierstein's ball in its beak and flew away over the marsh toward Lombard. The players are now asking for a special ruling, as the crow butted into a little syndicate and Gierstein refuses to settle."

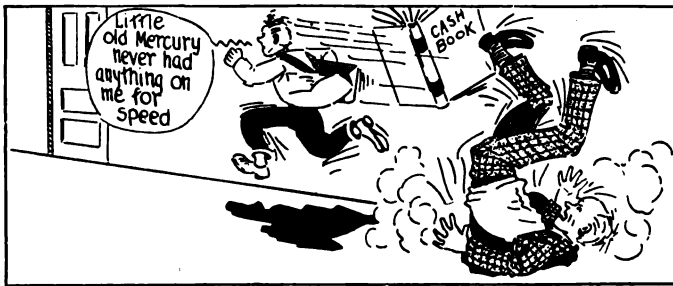

Dan Richardson, general auditor, gets in the way of one of the fast-moving units of the Clinton Street Pony-Express Messenger Service with disastrous results.

Philadelphia

L. R. Browne, Correspondent

We understand that Uncle Sam has adopted the telephone for use in his forest service. Surely, there could be nothing more appropriate than the running of "trunk" lines through our wooded preserves.

Except possibly the installation of Private Branch Exchanges!—Ed.

OH! CRUEL WORLD

The mild and cooling days are come,
The gladdest of the year,
When tales of fish and "mileages"
Assault the patient ear.

Heaped in the hollows everywhere
The golf ball dimly glows,
While brilliant blazers dot the greens,
And freckles dot the nose.

At night, the harvest moon's bright rim
Is sharp against the sky,
And in the hollows by the brook
Dim pools of night-mist lie.

The dusty road runs lazily
Across the hill and down
To meet the city's asphalt
At the edges of the town.

I journey it reluctantly
With heart filled full of pain,
For, woe is me, I'm on my way
Back to my desk again.

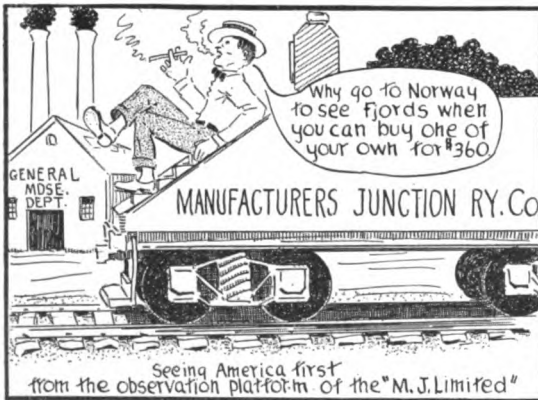

Seeing America first from the observation platform of the "M. J. Limited"



Spilling the Beans in Boston.



At the New Union Station in Kansas City— Watching the transcontinental trains stop and depart.

SPEAKING OF VACATION CONTESTS.

Here are a Few Episodes in the Little Old Annual Two Weeks of Dearborn Potter-Palmer McCormick, Chicago's Rising Young Service Clerk.



Behold a bout that we had at a club affair recently. The participants are "Kid" Brown, on the left, and "Fighting Jack" Leonard, on the right. The decision was in favor of "Fighting Jack" who scored a knockout at the end of the third round. In respectable life, these two individuals are known as Charles J. Brown, of the Telephone Service Department, and Elizabeth G. Leonard. Both are really respectable, although their appearance as portrayed does not seem to bear out that statement.

Cleveland

W. H. Quirk, Correspondent

"PEP"

(With particular reference to W. A. W. Inspirational Talk No. 1)

Our Philip read the August NEWS,
With solemn mien and mental views
Quite unexpressed—until he spied
Beneath a classic headline—wide
A bit of prose by W. A.
That made him blink his eyes and say—
"Well, Hully Gee! I should be hep
But what does Willy mean by 'pep'?
I think I'll write and have him show
The proper way that I should grow
So that when I am twenty-eight
They'll say of me—'My! ain't he great!'"

So Philip set him down and wrote—
To Mister Wolff—a Wilson note,
And asked him if he'd please explain
Just what he meant by "pep"—again.
But Billy being on the Staff
And worried, lest he'd draw a laugh,
Just wrote to Philip—"Pep is what
The bunch at Cleveland haven't got!"

Now Philip, tho' an office boy,
Was made of more than mere alloy,
And any little slam like that
Flipt in the ring his old straw hat.
So Philip got himself some books,
And lost himself in various nooks
Until he knew the world's big men
Clear up and down the line again.
And, as he studied, he got "hep"
To what Wolff meant by that word "pep"—
And as he learned, he passed the word
Until the bunch at Cleveland heard.

And now there's pep in Cleveland town
There's pep, that failure cannot down.
There's pep in every move made here,
There's pep soaked through the atmosphere.
The girls put pep into their punch,
And bring their pep back after lunch.
The salesmen don't hang 'round "no more"—
They leave their orders at the door,
And out they go—on business bent
To make their pep help pay the rent.
The packer, in each barrel and crate,
Packs pep, with things that go by freight.
And when the customer gets the lot—
Of first-class pep—he takes a shot
And back he comes with "biz" galore,
As well as cash to pay the score.

Our bonuses that once were nil
Now give us quite a pep-tic thrill;
And we could show you many a way
Where pep has helped us all make hay.
But time and space do not permit
Of any other pep-ful hit—
Although before we close the shop
We'd like to thank you Wolff, old top,
For putting our own Philip "hep"
To what you meant by that word "Pep."

THE FAN SEASON

Well, it's over!
A thousand and more we had back in June
A thousand or more were shipped mighty soon
A thousand and more—you all know the tune—
Season's over!

Yes, it's over!
The noble "six hundred" had nothing on us
Fan salesman to trucker—with never a fuss,
The fans they went out—at two-forty—plus
Till 'twas over!

Do it over!
The wind is a-rustlin'—the brown-turning trees
And old Winter will catch us—before you can sneeze—
But still if we'd ask—you would say—"next year please
Do it over"!

Western Electric Dealer Makes Unusual Auto-Camping Trip

IF you own such a thing as an automobile and want to go to a distant convention, and don't want to put up at hotels all along the route, and do want to cook your meals yourself and sleep in the open air—consider the example of A. L. Swanson, of Evansville, Indiana, who has been handling Western Electric appliances in his city for the last fifteen years. You can see from the accompanying picture how very simple it all was.

"My wife and I," says Mr. Swanson, "started to New York to attend the Electric Dealers' Convention and to visit the main offices of the Western Electric Company. Our trip included Indianapolis, Cleveland, Buffalo, Lake George, Massachusetts, back down the Hudson to New York, then home via Philadelphia and Pittsburgh. Practically 3,000 miles in a roadster, camping all the way with a complete camping outfit which we designed ourselves. And only one puncture! And without stopping at a garage for repairs!

Mr. Swanson spent considerable time visiting our offices while in New York and expressed great satisfaction over his trip and its object.



The Remarkable Automobile Camping Outfit of A. L. Swanson and His Wife.



CURRENT AWARDS OF OUR SERVICE BADGES

Awarded During September

<p>TWENTY-FIVE YEAR CLASS</p> <p>C. EffertzHawthorneSeptember 1</p>		<p>TEN-YEAR CLASS</p> <p>Bessie PowersNew YorkSeptember 17</p>	
<p>TWENTY-YEAR CLASS</p> <p>James W. Johnston.....New YorkSeptember 16</p>		<p>E. KeaneNew YorkSeptember 12</p>	
<p>FIFTEEN-YEAR CLASS</p> <p>E. MurphyHawthorneSeptember 10</p>		<p>Anna J. Boylan.....New YorkSeptember 17</p>	
<p>Henry OttHawthorneSeptember 3</p>		<p>Mary A. Maher.....New YorkSeptember 24</p>	
<p>C. T. HarmerHawthorneSeptember 6</p>		<p>Minnie Oyster.....New YorkSeptember 24</p>	
<p>F. H. Dost.....HawthorneSeptember 8</p>		<p>R. B. Munroe.....New YorkSeptember 18</p>	
<p>Lizzie McCarville.....HawthorneSeptember 15</p>		<p>E. P. Skubic.....HawthorneSeptember 6</p>	
<p>G. H. E. Krueger.....HawthorneSeptember 16</p>		<p>F. H. Ulrick.....HawthorneSeptember 7</p>	
<p>John HarperHawthorneSeptember 3</p>		<p>A. L. Shepard.....HawthorneSeptember 10</p>	
<p>A. H. Adams.....New YorkSeptember 3</p>		<p>J. Oliverius.....HawthorneSeptember 12</p>	
<p>J. H. Warren.....New YorkSeptember 21</p>		<p>F. Voboril.....HawthorneSeptember 23</p>	
<p>Jessie A. Mickey.....PhiladelphiaSeptember 30</p>		<p>W. Bottger.....HawthorneSeptember 5</p>	
<p>TEN-YEAR CLASS</p> <p>J. L. Wood.....ChicagoSeptember 6</p>		<p>J. T. Griffin.....HawthorneSeptember 6</p>	
<p>F. E. Short.....ChicagoSeptember 10</p>		<p>A. Wiggers.....HawthorneSeptember 7</p>	
<p>Mae L. Cassidy.....DenverSeptember 5</p>		<p>D. S. Toole.....HawthorneSeptember 12</p>	
<p>Melvin Taylor.....DenverSeptember 24</p>		<p>A. Piotrowski.....HawthorneSeptember 13</p>	
<p>Peter S. Todd.....San FranciscoSeptember 7</p>		<p>A. Johnson.....HawthorneSeptember 14</p>	
<p>Howard H. Elbert.....San FranciscoSeptember 18</p>		<p>J. Picalek.....HawthorneSeptember 18</p>	
<p>R. W. Billings.....Kansas CitySeptember 18</p>		<p>I. T. Rude.....HawthorneSeptember 18</p>	
<p>J. T. Brady.....New YorkSeptember 14</p>		<p>J. Micchals.....HawthorneSeptember 19</p>	
<p>C. R. Bryson.....New YorkSeptember 10</p>		<p>C. A. Neuman.....HawthorneSeptember 19</p>	
<p>G. W. Latham.....New YorkSeptember 6</p>		<p>P. E. Butler.....HawthorneSeptember 20</p>	
		<p>A. Schiff.....HawthorneSeptember 20</p>	
		<p>E. J. Porten.....HawthorneSeptember 21</p>	
		<p>W. R. Johnson.....HawthorneSeptember 26</p>	
		<p>L. Kempiners.....HawthorneSeptember 6</p>	
		<p>C. Platz.....HawthorneSeptember 18</p>	

Their Badges Show One Star or More



C. Effertz, Dept. 6347, Hawthorne



J. W. Johnston, Treasurer



E. Murphy, Hawthorne



Henry Ott, Dept. 5376, Hawthorne



C. T. Harmer, Dept. 6422-A, Hawthorne



F. H. Dost, Hawthorne



Lizzie McCarville, Dept. 7381, Hawthorne



George Krueger, Dept. 6460, Hawthorne



John Harper, Hawthorne



A. H. Adams, Dept. 6399, Hawthorne



J. H. Warren, General Sales, New York

To Be Awarded During October

<p>THIRTY-FIVE YEAR CLASS</p> <p>F. B. UhrigKansas CityOctober 1</p>		<p>FIFTEEN-YEAR CLASS</p> <p>T. R. Hutchins.....HawthorneOctober 22</p>	
<p>TWENTY-YEAR CLASS</p> <p>J. E. Legg.....New YorkOctober 1</p>		<p>G. SlocumHawthorneOctober 22</p>	
<p>FIFTEEN-YEAR CLASS</p> <p>A. A. Wiltse.....HawthorneOctober 19</p>		<p>L. RoseneHawthorneOctober 25</p>	
<p>T. H. Butler.....HawthorneOctober 2</p>		<p>A. F. Soutar.....HawthorneOctober 24</p>	
<p>G. W. Johnson.....HawthorneOctober 4</p>		<p>O. G. Bonorden.....MinneapolisOctober 7</p>	
<p>V. DeBartolo.....HawthorneOctober 9</p>		<p>J. Bray.....San FranciscoOctober 1</p>	
<p>E. Erickson.....HawthorneOctober 14</p>		<p>J. E. Lavens.....New YorkOctober 1</p>	
<p>G. A. McFarlan.....HawthorneOctober 17</p>		<p>W. M. Post.....New YorkOctober 2</p>	
<p>H. Janetzky.....HawthorneOctober 21</p>		<p>C. A. Ward.....AtlantaOctober 3</p>	
		<p>Clara Buell.....ChicagoOctober 23</p>	
		<p>John M. Eberts.....ChicagoOctober 29</p>	

TEN-YEAR CLASS

George L. Chestnut.....	Dallas	October 20
J. C. Crupper.....	Denver	October 24
D. Bruggeman.....	Hawthorne	October 1
P. C. Barnjum.....	Hawthorne	October 3
J. H. Scott.....	Hawthorne	October 17
W. L. Jonathan.....	Hawthorne	October 22
L. J. Moravec.....	Hawthorne	October 23
W. A. Dixon.....	Hawthorne	October 2
A. J. Price.....	Hawthorne	October 5
R. B. Smith.....	Hawthorne	October 9
L. M. Dunn.....	Hawthorne	October 10
S. O. Edohl.....	Hawthorne	October 10
A. C. Maska.....	Hawthorne	October 10
F. C. Haas.....	Hawthorne	October 11
C. B. Henion.....	Hawthorne	October 12
Catherine Rooney.....	Hawthorne	October 15
C. B. Arbeen.....	Hawthorne	October 16
P. Bloomquist.....	Hawthorne	October 17
J. J. Gannon.....	Hawthorne	October 22
V. Kozelsky.....	Hawthorne	October 27

TEN-YEAR CLASS

P. DiPasquale.....	Hawthorne	October 2
G. H. Ballard.....	Hawthorne	October 16
E. Lungershausen.....	Hawthorne	October 30
W. J. Mohr.....	Hawthorne	October 31
M. J. Lockhart.....	Hawthorne	October 22
A. A. Warczak.....	Hawthorne	October 23
J. L. Harrington.....	Hawthorne	October 23
Mary M. Nolan.....	Kansas City	October 15
Walter Eager.....	San Francisco	October 31
Marie D. Jensen.....	San Francisco	October 5
Fred Rommel.....	San Francisco	October 9
H. F. Michener.....	Seattle	October 12
E. A. Hawkins.....	New York	October 1
J. Brennan.....	New York	October 5
F. W. Clarke.....	New York	October 24
W. L. Filer.....	New York	October 17
O. D. M. Guthe.....	New York	October 3
C. W. Samsel.....	New York	October 1
May Byrne.....	New York	October 8
G. F. Hessler.....	New York	October 8

The Badges of These Men Show One Star or More



J. E. Legg, Adv. Dept., New York



A. A. Wittse, Dept. 6031, Hawthorne



T. H. Butler, Dept. 6336, Hawthorne



G. W. Johnson, Hawthorne

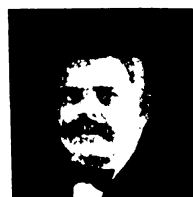

V. De Bartolo, Dept. 5551, Hawthorne



Edmund Erickson, Dept. 6300, Hawthorne



Herman Janetzky, Hawthorne



T. R. Hutchins, Dept. 6415, Hawthorne



A. F. Soutar, Dept. 5955-B, Hawthorne



O. G. Bonorden, Minneapolis



J. E. Lavens, New York

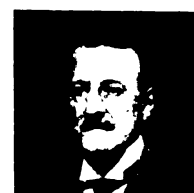

W. M. Post, Packing Dept., New York

Some Interesting Benefit Fund Figures

THE Employees' Benefit Fund has been used to take care of 682 accident and 880 sickness cases during the first seven months of the year. From it death benefits have been paid in 21 cases and pensions have been paid to 94 former employees.

The following tables have been prepared to make some comparison of the operation of the Plan at the various distributing houses. The figures include no employees of the manufacturing or other general departments:

COMPARISON OF SICKNESS CASES AT DISTRIBUTING HOUSES
FIRST SEVEN MONTHS OF 1916

House (arranged according to rank)	No. of days lost per 100 employees	House (arranged according to rank)	No. of days lost per 100 employees
1. Los Angeles.....	32	10. Atlanta.....	155
2. St. Louis.....	35	11. Boston.....	162
3. Pittsburgh.....	55	12. New York.....	171
4. San Francisco.....	79	13. Philadelphia.....	184
5. Omaha.....	90	14. Richmond.....	189
6. Seattle.....	94	15. Kansas City.....	194
7. Chicago.....	94	16. Dallas.....	220
8. Denver.....	106	17. Minneapolis.....	283
9. Cincinnati.....	125	18. Cleveland.....	455

It is to be noted that, with slight exceptions, the Central and Western States show the best health record. The

Eastern States show a uniformly high sickness record. It is likely climatic conditions are partly responsible for these figures.

Accident disability more accurately reflects local conditions largely under our control. We can guard our machinery and tools, educate ourselves as to safe practices and co-operate for safety, and this last is the most important.

The following figures are of interest as showing the accidents at the various distributing houses:

COMPARISON OF ACCIDENT CASES AT DISTRIBUTING HOUSES
FIRST SEVEN MONTHS OF 1916

(a) Showing Rank of Houses by Number of Cases per 100 Employees.

House (arranged according to rank)	No. of cases per 100 employees	House (arranged according to rank)	No. of cases per 100 employees
1. Cleveland.....	.0	10. Denver.....	5.6
2. Omaha.....	1.5	11. Dallas.....	6.2
3. Seattle.....	1.6	12. Kansas City.....	6.5
4. Richmond.....	2.1	13. Chicago.....	7.7
5. Cincinnati.....	2.6	14. Philadelphia.....	8.7
6. St. Louis.....	2.8	15. Los Angeles.....	9.3
7. Pittsburgh.....	3.3	16. Minneapolis.....	9.6
8. New York.....	5.0	17. Boston.....	10.3
9. Atlanta.....	5.5	18. San Francisco.....	12.5

(b) Showing Rank of Houses by Number of Days Lost per 100 Employees.

House (arranged according to rank)	No. of days lost per 100 employees	House (arranged according to rank)	No. of days lost per 100 employees
1. Cleveland	0	10. Kansas City	35
2. Seattle	0	11. Atlanta	35
3. Cincinnati	4	12. Pittsburgh	37
4. St. Louis	6	13. San Francisco	48
5. Omaha	20	14. Boston	58
6. Dallas	22	15. Richmond	58
7. Chicago	22	16. New York	67
8. Philadelphia	27	17. Denver	78
9. Minneapolis	32	18. Los Angeles	128

Pension Notes

Josef Hanus, of the Inspection Department, Hawthorne, died August 17th, aged twenty-five. J. J. Muzika, a machinist at Hawthorne, died August 1st, aged thirty-two. Both these men had been with the Company for more than five years but less than ten and the widow of each will be paid one-half year's wages of the deceased husband.

When planning to be temporarily out of the service of the Company, see your superior about a leave of absence; it may save you credit for years of service and secure sickness and death benefits to you and your family.

Every year added to your service record pays an additional premium on your old-age annuity (pension); it may mean thirteen weeks' additional sickness benefits for you; it may mean a half year or a year's pay to your widow, mother or children.

The death of Miss Frances L. Burns, on September 5th, after a brief illness at Roosevelt Hospital, was a profound shock to her friends and co-workers in New York. Miss Burns entered the Company's employ July 23, 1906, and very shortly thereafter was transferred to the engineering department, serving up to the time of her death in that organization in a secretarial capacity, where her efficiency and ability were readily recognized.



NEWS FROM HEADQUARTERS

Some Items of Interest from the General Departments

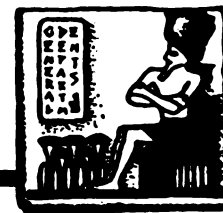

AFTERMATH

From mountain and seashore, farm and lake,
The throngs and their sunburn are back,
And wondrous tales have they to tell—
When listeners do not lack.

The chap who travels with reel and rod
To the place where the fish abound,
Will fill you up with the bass he caught,
Till you dread it when Friday comes 'round.

The charming maid who pounds the keys
At the shore had a gorgeous time,
For her gentlemen friends were simply grand,
And the moonlight was—well—sublime.

The camera fiend got some wonderful scenes,
And he hauls out a batch that he took—
But his family and friends are the foreground in each,
For the view, you can vainly look.

The golfer it seems had the time of his life,
He never played better or more—
Though he went 'round alone, he admits, on the day
That he rolled up that wonderful score.

The autoist raves if he's given a chance
Of his mileage per gallon and such—
What he saw on his trip didn't matter a bit,
That's a detail you'd better not touch.

From mountain and seashore, farm and lake,
They're back at their desks once more,
And the sunburn will cover the blush of shame
While they tell their vacation lore.

—W. A. Wolff.

A DISTRICT managers' conference was held at the Chalfonte Hotel, Atlantic City, during the week of September 11th. Vice-President Swope presided at the sessions, and the following were the conferees:

O. D. Street
E. W. Rockafellow
F. H. Leggett
E. P. Clifford
F. A. Ketcham
F. B. Uhrig
G. E. Cullinan
F. B. Gleason
C. H. Minor
P. K. Condict

Problems of the sales department were discussed during the week in sessions morning, afternoon and evening, but on one evening the members of the conference laid aside their business cares and enjoyed among themselves a little "stunt" dinner. Details of the fun did not percolate through to the editorial offices of the NEWS, but the NEWS was able to secure a photograph of the mysterious, dreamy-eyed cat which is said to have been presented to Mr. Rockafellow. The photograph is reproduced herewith.



Expression on Chalfonte Hotel's Cat While Listening to the District Managers' Conference

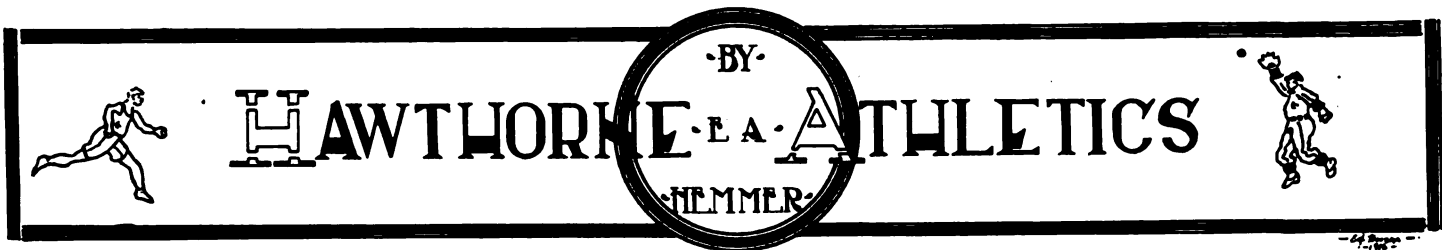

Fourth Inter-departmental Track and Field Meet

THE Fourth Annual Inter-departmental Track and Field Meet was held at Hawthorne on August 19th. Over one hundred athletes participated in the various events. The meet was attended by a large number of enthusiastic rooters, and was further enlivened by the Western Electric Band. The entire Hawthorne organization was divided into four teams, grouped as follows:

1. Clerical, Production, Plant, Merchandise, Installation and Educational Branches.
2. Technical and Engineering Branches.
3. Inspection Branch.
4. Operating Branch.

The Operating Branch won the meet by a close margin. It captured 58 out of the total 148 points. A number of exceptional records were made. The most sensational were 10 feet 6½ inches in the pole vault and 5 feet 8 inches in the running high jump, both made by M. A. Kolb, and 45 feet 11½ inches in the 12-pound shotput, won by Chas. Besta.

The following is a summary of the results:

90-Yard Low Hurdles—Won by C. Collins, operating branch; A. J. Sommer, production, clerical, etc., branch, second; C. Gillies, operating branch, third; M. R. May, inspection branch, fourth. Time: 11 seconds.

90-Yard High Hurdles—Won by C. Collins, operating branch; E. Meineke, inspection branch, second; J. Rogers, operating branch, third. Time: 13 2/5 seconds.

100-Yard Dash—Won by W. E. Campbell, operating branch; A. J. Sommer, production, clerical, etc., branch, second; G. M. Spurling, operating branch, third; F. E. Turnbaugh, production, clerical, etc., branch, fourth. Time: 10 2/5 seconds.

One-Mile Run—Won by M. R. May, inspection branch; John Castopaulus, production, clerical, etc., branch, second; L. E. Smart, inspection branch, third; Thos. Chackinis, operating branch, fourth. Time: 5 minutes 5 seconds.

Two-Mile Run—Won by Geo. Davidson, engineering and technical branch; J. Castopaulus, production, clerical, etc., branch, second; T. Chackinis, operating branch, third. Time: 11 minutes 13 seconds.

Pole Vault—Won by M. A. Kolb, inspection branch; E. B. Miller, engineering and technical branch, second; L. E. Arnold, production, clerical, etc., branch, third; W. F. Campbell, M. T. Dempsey, W. A. Olson, production, clerical, etc., branch, and C. J. Rogers, operating branch, tied for fourth place. Height: 10 feet 6½ inches.

Standing Broad Jump—Won by C. Morris, operating branch; C. H. Brems, production, clerical, etc., branch, second; E. Larson, inspection branch, third; M. E. Farnsworth, production, clerical, etc., branch, fourth. Distance: 9 feet 2½ inches.

220-Yard Dash—Won by W. A. Olson, production, clerical, etc., branch; E. N. Spurling, inspection branch, second; P. R. Lehigh, inspection branch, third; M. R. May, inspection branch, fourth. Time: 26 3/5 seconds.

440-Yard Run—Won by A. Hempel, production, clerical, etc., branch; C. Gillies, operating branch, second; C. Morris, operating branch, third; G. Schmitz, engineering and technical branch, fourth. Time: 58 3/5 seconds.

880-Yard Run—Won by J. J. Babson, operating branch; R. B. Smith, production, clerical, etc., branch, second; J. Zawitaj, operating branch, third; R. L. Doran, inspection branch, fourth. Time: 2 minutes 17 seconds.

Running Broad Jump—Won by C. Collins, operating branch; M. A. Kolb, inspection branch, second; W. E. Campbell, operating branch, third; R. E. Hollis, inspection branch, fourth. Distance: 21 feet 10 inches.

Running High Jump—Won by M. A. Kolb, inspection branch; Wm. Ludrick, inspection branch, second; E. Meineke, inspection branch, third; E. Lista, operating branch, fourth. Height: 5 feet 8 inches.

12-Pound Shotput—Won by Chas. Besta, production, clerical, etc., branch; John Antiochos, operating branch, second; V. Churchill, operating branch, third. Distance: 45 feet 11½ inches.

One-Half Mile Relay—Won by the Operating Branch team, consisting of J. J. Babson, C. Collins, G. N. Spurling and W. E. Campbell. Time: 1 minute 42 seconds.

Sack Race—Won by R. B. Smith, production, clerical, etc., branch; E. J. Klicka, engineering and technical branch, second; G. N. Spurling, operating branch, third; A. J. Sommer, production, clerical, etc., branch, fourth. Time: 7 minutes 3 seconds. (Scores for no points.)

Three-Legged Race—Won by W. S. Ford and Harry Zutt, production, clerical, etc., branch. Time: 14 minutes. (Scores for no points.)

Summary of Points

Operating Branch	58
Clerical, Production, Plant, Merchandise, Installation and Educational Branches.....	41
Inspection Branch	38
Technical and Engineering Branches.....	11

Final Standings of Clubs of the Inter-department Baseball League

Club	Won	Lost	Percentage
Jobbing Division	12	2	857
Switchboard Departments ...	10	3	769
Assembly Departments	10	3	769
Clerical Branch	10	4	714
C., R. & I. and Plant.....	4	10	285
Special Departments	4	10	285
Machine Departments	3	11	214
Technical Branch	2	12	142

Followers of the Inter-department Baseball League generally agree that the finish of the race was the closest it

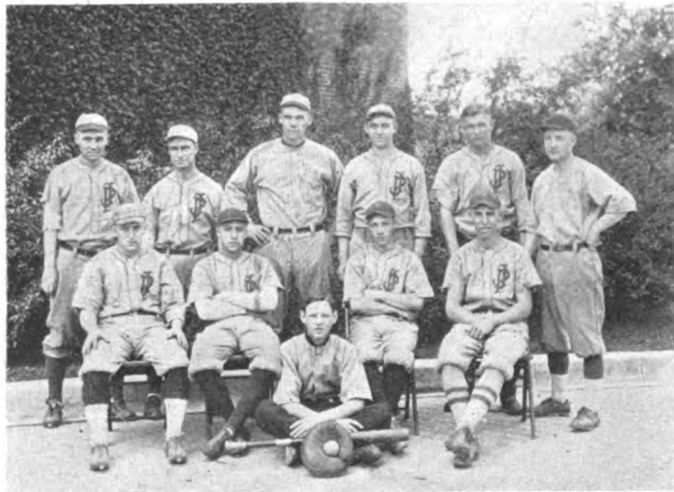

Jobbing Department's Team, Champions of the Inter-Department Baseball League for 1916.
 Back row (left to right)—Schreiner, 3b.; Lind, p.; Williams, lf.; Radke, rf.; Kuhlman, sub.; Wynne, cf.
 Front row (left to right)—Goski, c.; Simmons, ss.; Kukielski, mascot; Roser, 2b.; Bedore, 1b.

has ever been in the history of the league. Until the last scheduled game any one of the teams in the first division had splendid opportunity to land first place.

The Jobbing Team was fully entitled to the honor of winning the bunting. At the beginning of the season all teams showed considerable class. The teams finishing in the first division were superior to any of the teams in the same relative position at the finish in previous years. The Jobbing Team has been called "lucky," but outside of the usual luck of the game they won only through splendid team work and undaunted aggressiveness. No better argument can be advanced than the fact that they beat teams like the Switchboard, Assembly and Clerical, which were made up of players having more than ordinary playing ability. Other teams may have had better pitching material and may have excelled in other departments of the game, but no other team can boast of any better manager than "Pete" Schreiner, nor can the "dopers" show that the playing averages of any team are better than the champions, so all hats off to the Jobbing Team.

Bowling

The Seventh Annual Tournament of the Western Electric Bowling League was opened at Harry Steers' Palace Bowling Alleys on September 14th.

The league for this season as in former seasons will consist of eight teams, representing various divisions of the Hawthorne Works.

From the lists of men submitted by the various captains, it appears that many new faces will be seen on the alleys this year, and the question of superiority is more problematical than ever. The recent increase in the number of employees at Hawthorne presents a fine field from which to draw bowling material, and it is expected that the strength of each one of the teams will be materially increased over last season. Consequently higher team games and higher averages may be looked for.

Mr. Steers has made numerous changes in his bowling alleys for this season, making them the equal of any drives in the city.

The league will be composed of the following teams: Switchboard Departments, Production and General Merchandise, Cable, Rubber and Insulating Division, Clerical Branch, Machine Departments, Inspection Branch, Technical Branch, Engineering Department.

Hawthorne Tennis

"Q" SUBURBAN CHAMPIONSHIP

We entered a team in the annual "Q" suburban tennis championship tournament this year. R. D. Williams, D. S. Pratt, A. Dale and J. H. Biggar undertook to enhance the glory of Hawthorne tennis in competition with all the "crack" players along the "Q." Although their efforts to win new laurels for us were unsuccessful, they gained valuable experience, which they expect to put to good use in their endeavor to turn the trick next year. One of our close losses was J. H. Biggar's hard fought match with H. M. Ellinwood, former champion of Berwyn. The score was 6-2, 0-6, 5-7.

HANDICAP FINALS

Final results in the handicap tournament will be available for the next issue. Up to press date J. H. Biggar (handicap, minus one-half 30) and A. C. Jones (scratch) were the only men who had reached the finals.

In the championship singles, B. W. Huscher and J. H. Biggar had reached the fourth round, and D. S. Pratt, C. A. Cook and R. D. Williams had played into the semi-finals.

The championship doubles showed the following teams in the semi-finals: J. W. Letane-D. P. Craig; D. S. Pratt-J. H. Biggar; C. M. Smith-R. D. Williams; C. A. Cook-B. H. Huscher.

There has been a certain amount of mystery relative to our old champions, L. M. Wheeler and A. Dale. For the first time in their history as a doubles team they lost out in the first round, J. W. Letane and D. P. Craig being the perpetrators of the horrible deed. Perhaps Mr. Wheeler's strenuous efforts to turn all the ground west of Des Plaines Avenue into a truck garden had something to do with the result.

INTER-DEPARTMENT TOURNAMENT

It has been decided to extend the time for completing the inter-department tournament to the first of October. The drafting team has made a remarkable race and has now won the championship regardless of the results of the two remaining games they have to play. The race is now for second honors.

The standing at press date follows:

Team	Played	Won	Lost	P. C.
Drafting	40	35	5	.875
Eng. No. 1	28	20	8	.714
Cent. Works	34	24	10	.706
Merchandise	39	21	18	.538
C., R. & I.	38	20	18	.526
Eng. No. 2	31	7	24	.226
Production	28	6	22	.214
Clerical	40	7	33	.175

PLAYGROUND BASEBALL

The playground season was formally opened on September 7th with all the sidelights of a major league opening, including the moving picture men. An unusually large assemblage witnessed the opening games, large even for playground attendance, which has been larger than on any other sport.

In the first game the Engineering Team defeated the General Merchandise, while the Technical and Production defeated the youngsters of the Works Training Division, in the office section of the league. In the shop section, Department 6346 trimmed the Inspection Branch; the Jobbing Team won from the Switchboard crown and the C., R. & I. Division defeated the Tool Room.

Western Electric News

Vol. VI. No. 9

November, 1917

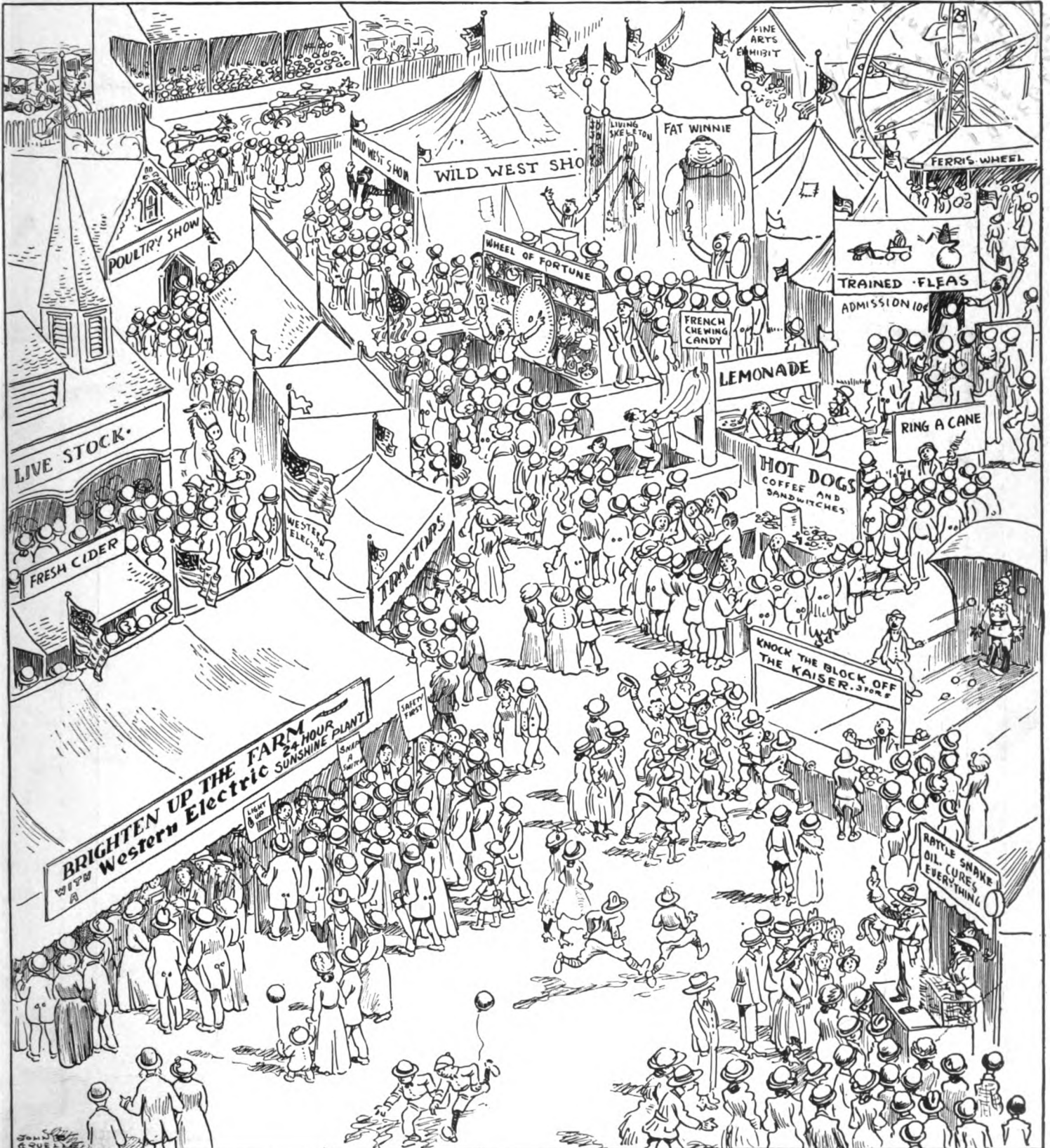

WE GO TO THE FAIR

FOR YOUR XMAS GIFT LEADER

THE TOY
FOR
GIRLS

THE TOY
THAT
TEACHES



THE *Western Electric* JUNIOR RANGE

This miniature electric range is the most satisfactory answer to the question, "What can we give our little girl for Christmas that will be instructive as well as amusing?"

Your electric shop will be Santa Claus headquarters if you prepare yourself to fill the demand that question is bound to create—a demand that will be stimulated by national magazine advertising.

The range is practical and safe to use—it cooks, bakes, fries and boils—real food can be prepared—and a full set of cooking utensils is furnished with it—as well as a little cook book.

Feature this range as your Christmas leader—send for a supply of the small folders "See what I cooked"—ask for plates for newspaper advertising—get our lantern slides—all free.

Remember that the Junior Range will help to get the idea "Do It Electrically" across to the younger generation—the older people, too.

Order your stock—your sales helps—now.

Western Electric Company

INCORPORATED

MEMBER OF

New York	Atlanta	Chicago	St. Louis	San Francisco
Buffalo	Savannah	Cleveland	Cincinnati	Oakland
Newark	Birmingham	Indianapolis	Kansas City	Los Angeles
Boston	New Orleans	Detroit	Omaha	Seattle
New Haven	Charlotte	Milwaukee	Oklahoma City	Portland
Philadelphia	Baltimore	Minneapolis	Dallas	Salt Lake City
Pittsburgh	Richmond	St. Paul	Houston	Denver

EQUIPMENT FOR EVERY ELECTRICAL NEED

This advertisement—the forerunner of the CHRISTMAS season—appears in the current issue of **Electrical Merchandising**

The Liberty Loans

Western Electric Employees Subscribe More Than a Million and a Quarter Dollars

Per Cent. of Total Number of Employees Who Subscribed To Either Loan

Richmond.....	100
Cincinnati.....	90
Atlanta.....	85
San Francisco.....	84
Dallas.....	81
St. Louis.....	80
195 Broadway.....	79
Chicago.....	79
New York Distributing.....	75
Philadelphia.....	73
Cleveland.....	71
New York, Engineering.....	64
Los Angeles.....	62
Seattle.....	58
Omaha.....	57
Minneapolis.....	57
Pittsburgh.....	56
Hawthorne (All Depts.).....	48
Kansas City.....	47
Denver.....	42
Total.....	53

The Total Subscriptions to Liberty Loans were as follows:

	Subscribers	Amounts
Second Liberty Loan - - - - -	12,447	\$875,650
First and Second Liberty Loans - - -	15,547	1,275,350

Western Electric News



H. B. Thayer, *President*; H. A. Halligan, *Vice-President*; W. P. Sidley, *Vice-President and General Counsel*; A. L. Salt, *Vice-President and General Purchasing Agent*; Gerard Swope, *Vice-President and General Sales Manager*; H. F. Albright, *Vice-President and General Superintendent*; J. W. Johnston, *Treasurer*; F. B. Jewett, *Chief Engineer*; G. C. Pratt, *Secretary*; R. H. Gregory, *Comptroller*; C. E. Scribner, *Consulting Engineer*

Office of publication and address of President, Secretary, and Treasurer, 195 Broadway, New York City

BOARD OF EDITORS

P. L. Thomson, *Editor-in-Chief*; W. F. Hendry; F. J. Holdsworth; H. D. Agnew; W. E. Leigh
E. C. Estep; S. W. Murkland; William Jabine; Reed Calvin

Subscription: \$1.50 per year, except to employees of the Western Electric Company, to whom copies are furnished free of charge.

All communications and contributions should be addressed to WESTERN ELECTRIC NEWS, 195 BROADWAY, NEW YORK.

Matter intended for any given issue must reach New York not later than the 12th of the preceding month.

VOLUME VI

NOVEMBER, 1917

NUMBER 9

We Go to the Fair

COUNTRY folk go to the fair once a year, but the Western Electric Company was born and brought up in the city, and having discovered only recently that such things as county fairs existed, has been making a regular glutton of itself by attending every fair it could find. From one end of the country to the other it has made the circuit of the county and state fairs in the last three or four months, and its slogan "Brighten Up The Farm" has become a familiar sight at fairs in every nook and corner of the land.

It might be supposed that such a round of county fairs would prove wearisome even to such a confirmed city dweller as the Company has been all these years, but such has not proved to be the case. Each fair has something that makes it differ from its neighbors, something new and refreshing always is turning up in the most unexpected places, and altogether its countrywide invasion of the county and state fairs has proved so interesting to those who have been fortunate enough to have a part in it, that the News has undertaken to tell the other members of the Company's big family what the Company has been doing and what its workers at the fairs have seen and heard.

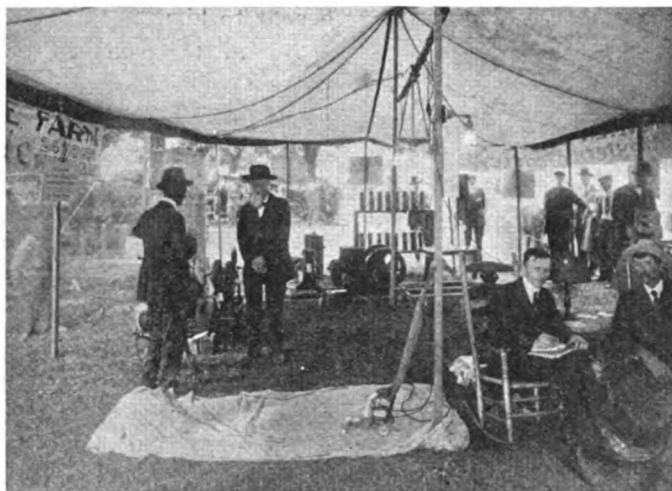

A Western Electric Tent at a County Fair. Telling a Farmer How to Do Things Electrically

"How has the county fair changed since the days when I was a boy?" will be the question that those who were born in the country will ask. In its essentials, the county fair has changed but little; it is an institution that is not susceptible of any great changes without destroying its very existence. Some features are less prominent than they were in days gone by, others that used to be hidden away in some obscure building now occupy the

place of honor, the trotting races have given way to automobile contests at some fairs, and other changes of like nature have come with the passing years, but in the main, the county fair is what it always has been, and in all probability always will be, an annual gathering of the residents of the whole countryside at which they divide their time with delightful impartiality between the instructive exhibits and the more frivolous attractions of the Midway.

If anything, the instructive side of the county fair is in the ascendant at the present time, and the farmer is devoting a little more attention to the useful things on show than to the amusements set before him. He doesn't fail to visit the Midway, but he spends much more of his time in wandering around asking questions

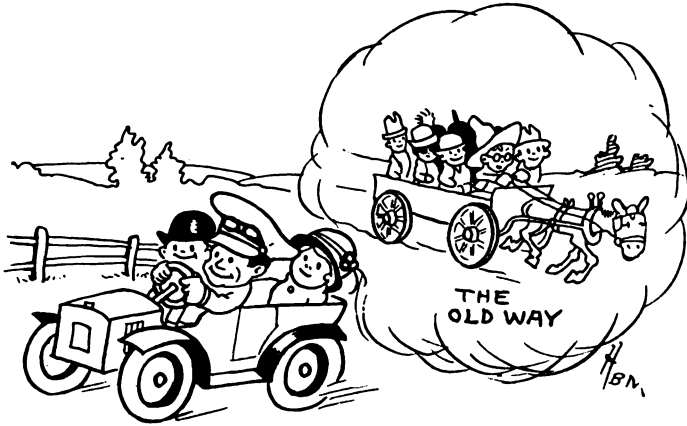

It's an Easy Trip Now

about the various exhibits, and his inquiries show a knowledge that often makes the demonstrator think twice before giving an answer. It is pretty hard to deceive the modern farmer about anything that relates to his farm, although he will stand before some fakir in the Midway and seemingly believe every word which flows from the man's lips. At such times he is only proving the truth of Barnum's statement that the American people like to be fooled.

Every Farmer Has His Car

Getting to the fair is not the tedious process that it used to be; in fact, one of the greatest changes of all is the substitution of the automobile for the horse. No longer does the farmer have to start at dawn with his whole family crowded into his staunch democrat wagon in order to reach the fair in time to see all that is to be seen, and get back home before midnight. Instead he does his chores as on other days, eats his breakfast at the usual hour, then gets out his car or his Ford and runs over to the fair. It may be held in the other end of the county, but the roads are good, and at most it is a ride of only an hour or two. And he doesn't have to take the whole family either. In the old days, they all had to go at once because it was impossible to spare the time for more than one trip to the fair, but now he can take some of the children on Monday, the others on Tuesday, and then go back alone on Wednesday to look over some of the things which had attracted his attention on previous days when he was too busy taking care of the youngsters to give much time to anything else.

It is that elimination of the old hustle and bustle in an attempt to see everything in the course of a few brief hours and attend to the pleasures of the little ones at the same time, that has helped exhibitors such as the Company to get the farmers interested in the things they have to show. At the present-day fair, a farmer may notice the farm lighting plant as he walks by on the first day of the fair, and later in the week will make a point of coming back to inspect it thor-

oughly. He knows that he can take his time, and the demonstrators know it too. They explain everything carefully and patiently, and if a sale is made each party feels that the other is getting exactly what he expected. If it were not for the farmer's friendly Ford, selling a farm lighting outfit to him at a county fair would be a much harder task than it is.

Another thing that the automobile has done is to make every farmer familiar with the workings of the gas engine, which again is a help to the Company in selling its outfits, for in most cases the motors are run by gas engines. Before he enters the exhibition tent, the modern farmer knows all about the engine, and what he wants to know is the amount of work he can get out of it by doing things electrically. In fact, the modern farm may be said to be full of machinery and a large part of every fair is given over to tractors, mowers, separators, and a host of other mechanical devices, in all of which the farmer takes keen interest.

Then there is the farmer's wife. She has not been forgotten by the Company in preparing its county fair exhibits. The washing machine, the electric iron, the vacuum cleaner, the electric sewing machine are all on view and many a plant has been sold to the farmer who was more anxious to lighten his wife's labors than he was to obtain the conveniences that would be of especial benefit to him.

But all this consists too largely of talking shop, and too little has been said about the other features of the county fair. The prize cattle and giant vegetables still hold their accustomed places in the wooden buildings and tents where the judges spend their time awarding the ribbons and cash prizes to the champions of the various classes. It is there that the specialists gather, the men who know all about soils and crops, and can tell you why your corn was a failure this year, and other like interesting information which usually happens along after it is too late to do any good. Of course you ought to remember what they say until next year, and profit by it then, but unless you have a retentive memory you are likely to forget all about it when you get

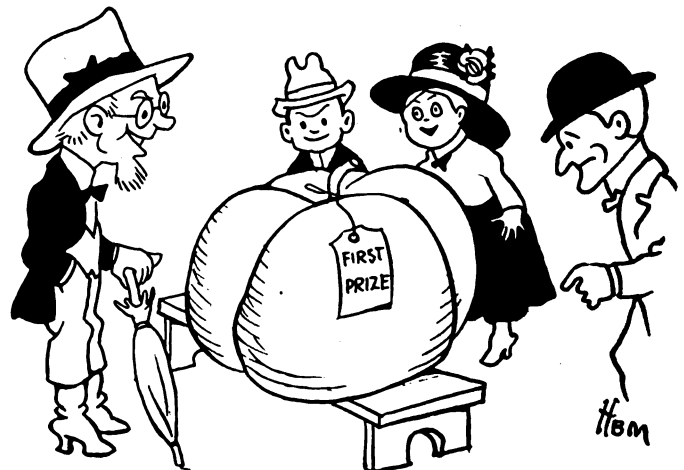

Some Pumpkin

out into the sunlight again, and are confronted by a man diving from a lofty and slender tower into a ridiculously inadequate pool of water, or some other sight equally thrilling, and equally unimportant to your future welfare.

This Way to the Midway

Such things are unimportant, no one can deny that, but what would a county fair be without them? Would the farmers flock from far and wide to the fairs, if all they saw when they arrived were the more serious and useful exhibits? It is to be feared that they would find that their home duties would prevent their attendance, and no one would blame them. The Midway is always



Spending His Money

crowded at every fair by a laughing, chattering throng, in which the young folks predominate, although there are none who can laugh louder or longer than some of the white-haired old gentlemen with G. A. R. buttons in the lapels of their coats.

Some of the things along the Midway seem too foolish and trivial to attract any patrons, but, nevertheless, they all make money. One man who is much in evidence at every fair is the voluble vender of Rattlesnake Oil which he extols as a cure-all, a sure and certain remedy for every ill known to man or beast. With his snakes in one hand, and his bottles in the other, he pours forth gushing torrents of words that hold his audiences spell-bound until the psychological moment arrives and the actual sale of his sovereign remedy begins. Exactly what is in the bottles no one ever has been able to find out, but they are snapped up by the crowd as fast as his assistant can hand them out.

Then there is the pleasant pastime of pitching rings over various attractive objects a few feet behind the rail. The prettiest girl on the ground usually is the queen of this establishment, and her customers are so dazzled by her beauty and her winsome smiles, that they forget to notice that the objects over which they are trying to toss the rings are a size or two larger than the rings themselves. Of course there always are a few much less desirable trophies over which the rings will

fit with plenty of room to spare, but who wants to ensnare them? They are there, like the old Raines Law sandwich, in case anyone raises a question about the legality of the establishment when he suddenly awakes to the fact that he is trying to encircle a handsome clock with a ring just big enough to fit over the fair hand which has just passed it to him, and without pausing swept his change into her cash box beneath the counter.

Also the fortune-teller. She always has a steady stream of callers and as she generally predicts good luck for the future, her patrons go away feeling that they have received their money's worth. Perhaps they consulted her a year ago, received promises of many good things, and in the intervening months have had all sorts of misfortunes, but even then they believe her words of good cheer for the months which are to come. In fact, they are the ones who hang upon her words most breathlessly, for they most of all need the encouragement which she gives to them. So even if she does delude those who come to her, she probably does far more good than harm.

There are many other things which the Midway has to offer, the usual freaks who sit all day long in their tents to be gazed at by hundreds of curious eyes; the jugglers and acrobats; the moth-eaten lion or tiger in his cage; the carousel, and a host of other "attractions" which all do their share to add to the gaiety of the occasion and extract the dimes and quarters from the pockets of the passersby.

Some Old Friends

"What about the old-time gamblers? Where are they?" asks someone who ought to have omitted such unpleasant topics. Yes, they are still to be found, although they no longer practice their profession openly as they did in the good old days. On every fair grounds are long sheds where the farmers once hitched their horses, but which now are no longer used, as the Fords all seem to prefer the open-air parking spaces over by the trotting track. It is to these deserted sheds that the gamblers have been driven, but they don't seem to mind it. The young bloods manage to find them without much difficulty and the shell games and three-card-monte layouts flourish in all their glory. The money keeps on flowing from the pockets of the young farmers into those of the gamblers just as it has for many years past. Once in a while some one complains and the special constables are forced to expel the gambling gentry from their quarters, but they never get far away.

No fair is complete without food and drink. Ostensibly the latter consists entirely of soft stuff, but like the gamblers, the venders of the fiery liquors generally manage to find their way into the grounds, and if you are properly introduced it is not hard to exchange some perfectly good money for some perfectly poor whiskey.

As for the food, you may be inclined to turn up your nose when you pass the hot dog stand, and instead of patronizing it squander half a dollar or more at the restaurant conducted by the Ladies' Aid Society of the

local church. If you follow that procedure you will get an inkling of the origin of the expression "poor as a church mouse," and after you have consumed what the ladies have set before you, you will hasten back to the hot dog establishment and willingly yield up the dime which the proprietor demands before he satisfies your wants.

Just one thing more. This is a picture of a modern county fair, and the one thing which brings it up-to-date has not been mentioned. Once upon a time you paid five cents for the privilege of throwing three rather mushy baseballs at the head of a nigger, either real or artificial, preferably the former. That is now hopelessly out of date. You still pay five cents and throw the three balls, but you cast them with all the strength that is in you at the head of the Kaiser. Unfortunately the Kaiser is never real, he always is arti-

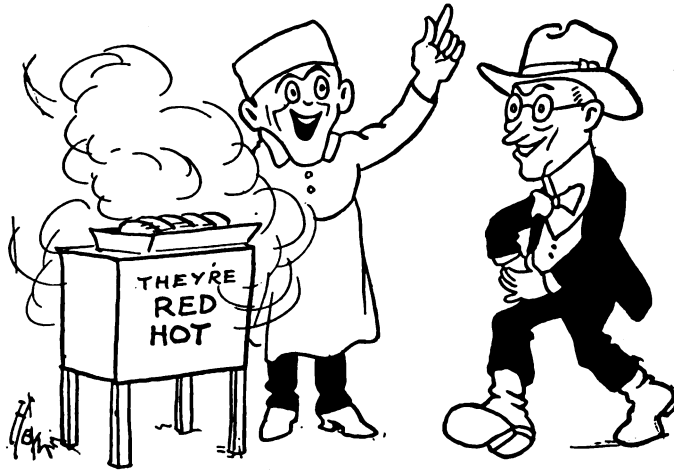

Back for Some Real Food

ficial, but if some of the boys in khaki who have been pounding baseballs into his dome at county fairs all summer keep up the same excellence of aim when they reach the shores of France, they may get a chance to shoot at the real thing before they come back home.

Each ball that hits the Kaiser's shining face sends out a puff of dust that adds its mite to the clouds that permeate every nook and corner of the fair grounds. Some day some genius may invent a dustless county fair, or the Company may turn out a vacuum cleaner gigantic enough to keep the whole neighborhood spick and span, but until that day comes the dust will be always with you when you go to the fair. But it is dust that is stirred up by the feet of a happy merrymaking throng, a throng composed of the people who after all are the backbone of the nation, so perhaps it ought to be forgiven.

Mr. O. D. Street's Work With the Stores Committee of the Munition Board

The various ways in which the company is co-operating with the United States Government in its great task of prosecuting the war are so many that it is difficult to keep track of all of them. The big thing, of course, is the expeditious manufacture of those articles needed by the Army and Navy which the company is peculiarly fitted to make, but that is by no means all that the company is doing.

Several executives of the company have been working in an advisory capacity with the Stores Committee of the Munitions Board at Washington, D. C., and on August 16, at the invitation of the Chairman of this Committee, Mr. Street delivered a talk at the War College in Washington, be-

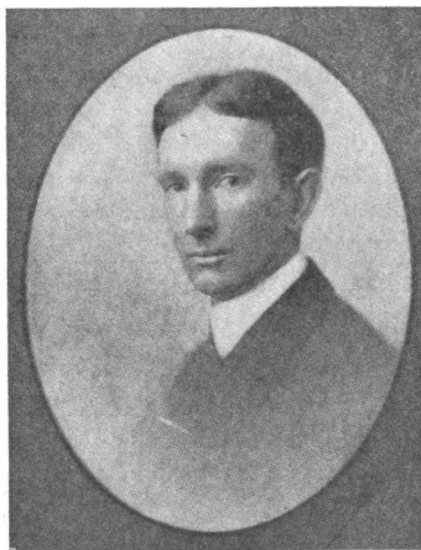

O. D. Street, Asst. Gen. Sales Mgr.

fore a group of military authorities in charge of handling supplies for the various branches of the military service. Mr. Street's talk dealt with the Western Electric plan of purchasing, warehousing and distributing supplies.

The company has been co-operating with these officials at Washington, who are being called upon to solve the growing problem of handling and accounting for the immense volume of supplies which will be used by the Army and Navy, and one of the results has been the establishment of the Western Electric system in the Quartermaster's Depot at New York and in the Medical Supply Depot at New York.

A Nurse in Flanders

In a Simple, Unassuming Way Miss Jane Rignel Writes
of Her Work Behind the Lines

(The following letter written to Mr. F. L. Gilman is reproduced in the News without first obtaining Miss Rignel's permission. This is a violation of a long standing rule, but the readers of the News may judge for themselves whether the violation was justifiable.)

Flanders, September 29, 1917.



Miss Jane I. Rignel

SOME time ago I received your note and a form signed by Dr. Jewett stating my present standing with the Western Electric Company. I fully intended writing to you directly to thank you for your keen interest and the many kindnesses you have shown us. But somehow I neglected doing it at the time, and

have since then been extremely busy. We have been here in Belgium for about three weeks, and having a wonderful experience, mingled in with a taste of real warfare.

A surgical team was first chosen three months ago to go to a Casualty Clearing Station (C.C.S.) and I can well remember how enthusiastic I was the day they left. Well, they had a bit of hard luck—were bombed soon after they came here, and one of the nurses, a Miss MacDonald, was unfortunate enough to receive an injury to her right eye, necessitating the removal of the eye. When news of this reached us at our Base many felt scary about starting out. However, I felt very highly honored to be chosen to replace Miss MacDonald on a new surgical team.

We have the finest surgeon, Capt. F. B. St. John, an anesthetist, Lieut. R. V. Grace, an orderly and myself as surgical nurse. Without assuming too much vanity we have agreed that our team is one of the finest to be found anywhere. Capt. St. John is a clever surgeon and does wonderful work; it is a pleasure to be associated with him, even though we work many long hours and get terribly fagged out. It is most trying to operate on badly wounded men for twelve to sixteen hours at a stretch, with eight hours' rest in between.

The eight hours' rest is always more or less broken up by big "whiz bangs" overhead, or big gun fire, and very frequently the Hun planes engage in a little fun right over us. During the day the noises do not seem so awful, but at night one simply exerts all the faith one has and waits for daylight.

I feel certain we can never take the same interest in beautiful clear moonlight nights again—it means only one thing to us, an air raid and bombing. Night before last we were trying to operate on a patient when Fritz came over, and three times during the next half hour we fell flat on our abdomens, with steel helmets on our heads, and held our breath while our operating theatre was shaken with the vibration of eight huge bombs dropped uncomfortably close. Fortunately no casualties and no damage done that time. We always wish we had been better girls and boys about the time the big crash rattles so close. And yet we can remember the days when we were neutral. It would be a splendid thing for W. J. Bryan and LaFollette to be as uncomfortably close to the big noise as we are—they might change their attitude.

And now let me tell you how comfortably we are housed. There are three large Clearing Stations here, and in these Clearing Stations—which are often the second dressing station behind the line (the Field Ambulance being first)—all necessary operations are done and the cases evacuated to the base hospitals from this point. They are not kept any longer than is actually necessary, except chest and abdominal cases; I think the latter are kept about ten days. We have three surgical teams operating at night (we are on night duty) and four during the day. We can do about one hundred operations in twenty-four hours, with all teams working.

The cases are all badly wounded, some being worse than others, and we are continually taking out pieces of metal and other foreign bodies from arms, legs, chests, abdomens and knees. The other night we were surprised to lift out a shell bottom, about as large as the top of an ordinary tumbler, and one-half inch thick. It weighed more than $\frac{1}{4}$ pound, probably six ounces. This had been lodged in the calf of a man's leg and why it hadn't blown his leg off is a mystery. It must have been well spent by the time it struck him.

We live in bell-shaped tents, wooden floors, and have piles of sand bags around each tent to protect us from bombs and shells. I have a mattress on the floor and find it more convenient than a cot, because when a raid is on one must throw oneself flat on the floor and put on a steel helmet. Being already on the floor I have only to reach for my helmet and be still. Drs. Grace and St. John thought we would all be better protected this way, so they have a similar arrangement in their quarters. The tents are large and roomy, two nurses sharing each, and the life is a healthy one. The only objection is that one goes about stooping over, trying to wash in a small rubber basin (2x4), and attempting to have a peep at one's face in a mirror three inches long, $1\frac{1}{2}$ inches

wide. The luxury of clean white sheets, a hot bath, and a real mirror will be well appreciated when we return to the Base.

However, everyone realizes this is war and any inconvenience is hastily overlooked. As a matter of fact we are more comfortable than we really expected to be. The people we meet here are for the most part splendid types of men and women. I am so glad I came to France—how miserable I should have been at home, utterly miserable.

The satisfaction of knowing we are doing our bit is compensation enough for any trying circumstance. I have as yet to hear any Tommy, no matter how seriously wounded, complain; they are most optimistic and cheerful. We owe them much for their bravery, too.

Let me thank you, Mr. Gilman, for the copies of the NEWS which we have received; they are most interesting and keep us in touch with our past life. Miss Evans and I often wonder if we ever lived in the past, or will live in the future—we can only live each day by itself right here. The settling down to civil life again is almost like a dream. (Here I stopped to see our anti-aircraft guns shooting at a Hun plane sailing along at a tremendous height; it looks like a glistening toy.)

We are interested in the new radio companies you have organized of W. E. men. Do you think they will come here to France? Every time we hear of another contingent of engineers arriving we start out to see if there are any people whom we know, but it is difficult to get information here.

We would give a good deal to have a kodak up here, but of course they are strictly forbidden and we must carry all these scenes in our mind. The country about

is much the same as in our own land, not so well kept up, with many small cottages scattered here and there, some with red tile roofs and hundreds of them with thatched roofs. The villages are the limit. Narrow dirty streets, and such shops; one often has to go into queer looking places to make purchases. One interesting thing is that I often see the Prince of Wales—he is such a manly boy, bronzed complexion and light curly hair. I should imagine this life would have developed him considerably.

I wish I had time to write to more of my friends there, but it is almost impossible to keep up any large amount of correspondence. Letters are the brightest spots in our routine work and I hope you will pass along the word to some of my good friends. I am also asking you to remember me to any inquiring friends. Miss Evans and I are very well and very happy in our work. We are preparing for a long cold winter by the sea, with no heat in our rooms, nor any in our hospital wards. However, we have been furnished with sleeping bags, and if we can keep warm while asleep surely we can hustle around and keep warm during the days.

Please give our best wishes to all of our friends who have been so kind to us. We are depending a great deal on the prayers of our good friends and actually believe our faith is the only thing that makes this life possible out here. One thing is certain in Belgium at the present time, one has a closer view of our Master than ever before in any other place.

If you have time, Mr. Gilman, please write to us and let us know all about things generally.

Kindest regards to you, and many thanks for the courtesies extended to me by the Company.

A Surgeon at the Front

Two Letters from Dr. Roderick V. Grace, Who Is Now Close to the Battle Lines

No. 1 General Hospital, B. E. F., France.

Aug. 13, 1917.



Lieut. R. V. Grace

You appreciate, first of all, that we are attached to the British Expeditionary Force (B. E. F.) with the other American Units that left about the same time. These "loaned" units have been scattered in base (so-called general) hospitals along the lines of communications in France.

Let me give you a brief idea of how the sick and wounded are taken care of. In the trenches the battalions have their medical officer, who is installed in a dugout or wherever it is practicable to have him. He has a certain number of orderlies and stretcher-bearers and paniers with first-aid equipment. He in turn sends his cases to the Field Ambulance situated only a few miles behind the front trenches. The F. A. does only temporary dressing, elaborating and helping out the battalion M. D. The Field Ambulances in their turn send their sick and wounded back to the Casualty Clearing Stations, which are placed also often in the zone of shell fire and often get bombed or shelled by the Hun, purposely or otherwise.

At the Casualty Clearing Stations (C. C. S.'s) most of the real surgery is done to the freshly wounded. They are tended to by a force of medical officers which, in times of a push, is supplemented by teams of surgeons (officially called surgical team, consisting of operating surgeon, anesthetist, operating nurse and operating orderly.) These surgical teams are sent from the General Hospitals which are least busy, or which have surgeons of special

ability. The C. C. S.'s send their cases via ambulance train to the General Hospitals, and the General Hospitals in turn via motor transport to the hospital ships. A diagram of the thing will be thus:

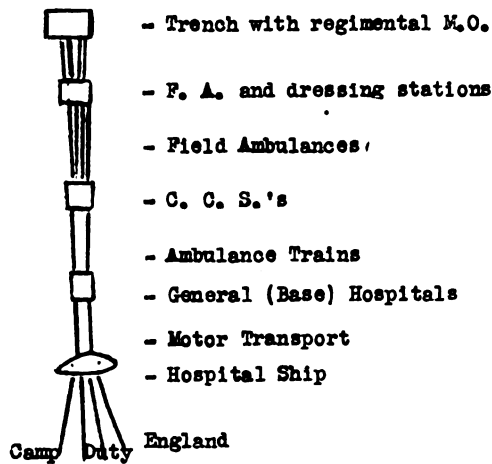

Cases in F. A. are treated only as little as is compatible with immediate needs. They may be treated for gas, etc. At the C. C. S. cases are retained for periods only as long as is necessary without endangering them. This may mean a few hours, days or even weeks. At the general hospitals cases are not supposed to be kept more than a few weeks, except dangerous ones, such as compound fractured femurs, etc. You would be surprised to see some of the cases we evacuate in order to keep the hospital ready to receive new ones. We are never allowed to lose sight of the fact that we are on the L. O. C. (lines of communication), and that the L. O. C. must never be allowed to be blocked. The difficulties of paper work or record is tremendous, and yet everything seems to be carried out with very good results.

Not long ago we had two convoys within a few days of each other. In a few days we admitted about four times the number of cases that the Presbyterian Hospital (New York City) has a bed capacity for. You can see from that that adequate history taking is impossible, as many of the cases have to be operated on—others have to be passed on to the hospital ship in order to always keep us open for more. To be awakened in the early morning—the assembly calling the men—to go through the work of emptying a train and filling the hospital is quite a thing. We are all used to it, as we have had many in the past few months.

Since coming here I have had charge of the officers' hospital, containing 74 beds. I have Dr. Swift as medical and Dr. Brewer as surgical consultant, so I am learning a little. We have some badly shot up cases. One young Scot had 50 to 55 bomb wounds on him.

* * * * *

September 14, 1917.

I am now a member of a Surgical Team sent up to a Casualty Clearing Station in Flanders. Miss Rignel is the operating nurse. Since coming here we have done nothing but work and sleep—mostly the former. We are rather close to the Ypres sector and we drain from thereabouts for the most part. The different teams are on duty 12 to 18 hours out of each day, and do one case after another. I have never seen such wounds. I have never seen such a wonderful morale as these troops show. Shot to pieces as some of them are, never a question as to what is going to be done to them when they are brought in by the Field Ambulance direct to us. There is never a word of complaint or of self pity. You tell them to take a few deep whiffs of the chloroform and their only rejoinder is a respectful, crisp affirmative, and off they go while a surgeon does his best for them.

It is a cold night, although it is early September. Outside my tent there is pitch blackness, else I could not be sitting writing you this by light of a candle. On the clear nights the Boche planes come over and have an unpleasant way of dropping bombs on us. One of our U. S. nurses lost her eye—many of the patients have been killed or rewounded, and some officers. There is no possibility of there being a mistake. We are well marked by the Red Cross. Seems as if he is making a practice of hospital bombing all around. We each have our dug-outs in our tents or outside, and when the Boche comes over we get in till he is past. Rather a wonderful sight to see the searchlights pick him up and see the "Archies" try to bring him down, when he is several miles away.

Guns are going night and day—planes flying (i.e., ours)—troops passing up and down into or out of trenches all the time. Rather weird to see them so close up with their bands playing. Game men, these—going up to live (maybe) in mud and muck—to come out for a rest—to return, never knowing when it is for the last time. It makes you realize what a stern thing it is, and to what heights of self-sacrifice man can bring himself. My candle is going out. Good night—good luck.

No Answer Ready

We had a striking window display last week on the "DAYLO" line, showing a miniature house with nice lawns and drives and walks around it. The house showed that it had been on fire—windows broken, doorway charred, etc. Then all about it, in the foreground, were flashlights of all sorts and sizes. In the background were posters and advertising cards extolling the merits

of the Ever-ready line. You'd almost think it was a "regular" window display. The message was supposed to be "Use an Ever-ready." "Avoid Danger of Fire," etc. But, oh, hum. Just as the boys finished the job a customer reaches over and whispers "Wacha advertisin'? Fire extinguishers?"

D. E. S., Cincinnati.

MR. SWOPE INVADES THE CELESTIAL REPUBLIC



CHINESE KNEELING IN CENTER OF GREAT ALTAR.



MR. SWOPE ON LAUNCH CROSSING RIVER AT HANKOW.



CHINESE LADIES TRAVELING TO PEKING.



MR. M. C. SUN, CHAIRMAN CHAMBER OF COMMERCE AND PRESIDENT OF WUSIH ELECTRICAL LIGHTING COMPANY



TEMPLE OF HEAVEN, PEKING



FROM LEFT TO RIGHT:— ASST. MGR. OF KWANG CHING WEAVING & SPINNING CO. MGR. OF COMPANY; MR. SWOPE; MR. H. S. YOUNG PRESIDENT OF Co., MR. F. B. DUNN; MR. YOUNG'S SON



ALTAR OF HEAVEN LOOKING TOWARD TEMPLE



RUINS OF GEN. CHANG HSUN'S RESIDENCE AFTER BOMBARDMENT OF JULY 12TH

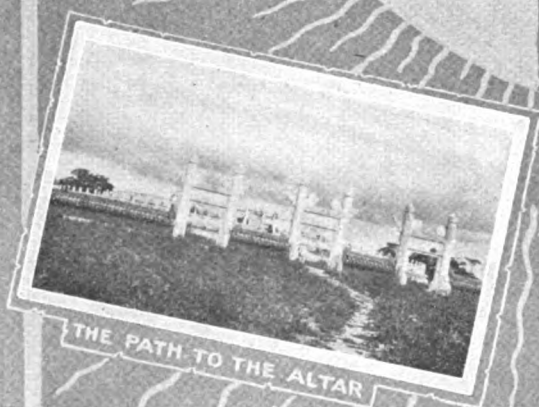

THE PATH TO THE ALTAR



TEMPLE IN NATIVE CITY AT HANKOW.



MR. SWOPE AND MR. CAREY ON GREAT ALTAR.



A Trip to Soochow and Wusih

By Frank B. Dunn

(Mr. Dunn is a native of China and several years ago was a student at Hawthorne)

AFTER continuous oppressive days, which are more or less familiar to a Shanghai resident, came a typical early June day—a day cool and pleasant for traveling. It was July 14, 1917, the fifth day of the arrival of our honorable guest, Mr. Gerard Swope, the highest "Boss" of the W. E. Co., Inc., employees ever touching the Shanghai soil, who quietly picked this remarkably nice day, without consulting the astronomer, to see the cities, Soochow and Wusih.

At five minutes to 8 o'clock in the morning the express train to Nanking, containing the W. E. party of three—Messrs. Swope, Fairman and myself—pulled out. It was a 64-mile travel which took the party to Soochow at 9.30 A. M. As the road from the station to Chongmien was comparatively wide, carriage was used to travel on this part of the city and then left it to enter the city gate Chongmien. Here the streets are too narrow for carriages as its width is about to allow three persons to walk abreast.

This is the place that will interest our honorable guest, as everything is a new sight to him. We went through the busiest part of the city and then came back by a street consisting of small stores. Mr. Swope took great interest and said "good-morning" to a few Chinese in the stores we passed and several of them returned with a smile, while one stood up and return the salute as if he understood the Chinese translation "Hau-tsou" or "Tsou," the latter meaning "morning" with the word "good" understood.

Soochow as a city is comparatively clean and the people speak a most pleasing language. It is also a fairly rich city in China; however, its commerce had been badly affected since the removal of the Governor to Nanking in the year 1911 and now it is a residential city rather than industrial.

The telephone exchange is controlled by the Government, consisting of two offices with a combined number of 540 subscribers equipped with standard sections of 100-line Western Electric Magneto Switchboards. The limited time to be spent in Soochow offer no opportunity to see the exchange. We then returned to the station, disengaged the carriage and took train to Wusih, where we reached at 15 minutes after noon.

The party headed by Mr. Swope then took sedan chair, each of which was carried by two coolies, for Wusih

Telephone Exchange. There are 464 subscribers at present in Wusih and 600 lines are equipped. It is probably the only exchange in China employing girl operators. The switchboard is of magneto type manual ringing. On leaving the exchange, the party was led to a pleasure boat as was previously arranged. While on board this boat Mr. Swope was introduced to prominent members of the city. I had the pleasure to give a dinner in honor of Mr. Swope and Mr. Fairman during which interesting conversations went on. The personnel on the table were:

Gerard Swope, Vice-President Western Electric Co., Inc., New York; F. F. Fairman, Manager Western Electric Co., Inc., Shanghai; H. S. Young, President and Managing Director Wusih Telephone Co. and Kwang-Ching Weaving & Spinning Co., Ltd., respectively; M. C. Sun, Chairman Chamber of Commerce, Wusih, President of the Wusih Electrical Lighting Co. and Chien-Sun Silk Filature; T. A. Tsiang, Senator of the dissolved parliament, Peking; C. Chow, President of several restoring godowns, Wusih; W. S. Tsar, Vice-Chairman of Chamber of Commerce and President of Kiufong Flour Mill, Wusih; T. C. Sunn, former Judge for the Chinese city of Shanghai; F. B. Dunn, M. Sc. Assoc. A. I. E. E., Sales Engineer Western Electric Co., Inc., Shanghai.

Mr. Swope, being interested in the Chinese Politics, asked many questions of Senator Tsiang. The following were of the more important ones:

Q. Do you think Gen. Tuan Chi-jui will be able to form a cabinet and hold on steadily? Ans. No, unless his cabinet is legally formed and his cabinet members have true spirit to maintain the Republic with real republican ideas.

Q. Do you belong to Kwomintang (democratic party)? Ans. Yes, indeed.

Q. Can you tell when the parliament will meet again? Ans. No, I do not know.

Q. When are you going to Peking? Do you like to go with me? Ans. Not for some time. No, thanks.

Q. Do you like to come over to the United States to see our Government? Ans. Yes, indeed. We had organized a commission to come to the States with a view to making a study of the U. S. constitution and come back to make necessary modifications before the present upheaval came up. However, we have postponed it indefinitely, as the political air is very dark at present. I will be delighted to come over should opportunity offer itself.

Note the conversation—our honorable guest lost no time in finding the senator being Kwomintang member. It is by no means easy thing for a foreigner who has just been in China for four complete days to judge people with much precision, especially in a country whose politics even often puzzled an experienced Chinese citizen.

The dinner was soon over and Mr. M. C. Sun led us through his silk filature. The whole process of taking silk out of cocoons was interesting to the visitors.

Female laborers to the number of 580 were employed exclusively by this works. According to Mr. Sun, almost all of their products now produced are exported to the United States. Special attention was given to the products to see that the quality meets the American market requirements.

Leaving the silk filature, Mr. Young took us to the Kwang-Ching cotton mill by his motor boat on which flew the Stars and Stripes, showing the friendship of the sister republics. It is one mile and half ride. The mill is equipped with 15,360 spindles and is capable to make yarns up to 42 counts. There are 980 female laborers and 380 male ones employed in this mill. The plant is of steam driven. The return voyage was also made by motor boat. On the way to the station we passed the pleasure boat and bid good-bye to those on board.

Wusih as a city is very progressive and is a typical Chinese-managed industrial center in China. There are three cotton mills, eight silk filatures, five flour mills and some other factories. The farming products are chiefly silk and rice. Good water supply, cheap labor and presence of wide waterways are to be counted for the industrial prosperity. The city is 90 miles from Shanghai and may be reached in three hours by train from Shanghai.

The party then broke up with Mr. Swope and Mr. Fairman going to Nanking at 3:45 P. M. where they boarded the river steamer for Hankow thence to Peking and I remained at Wusih where I used to spend my week ends as it is my home town. The W. E. staff at Shanghai, of course, wish bon voyage on our honorable guest's return tour.

Korea Comes Next

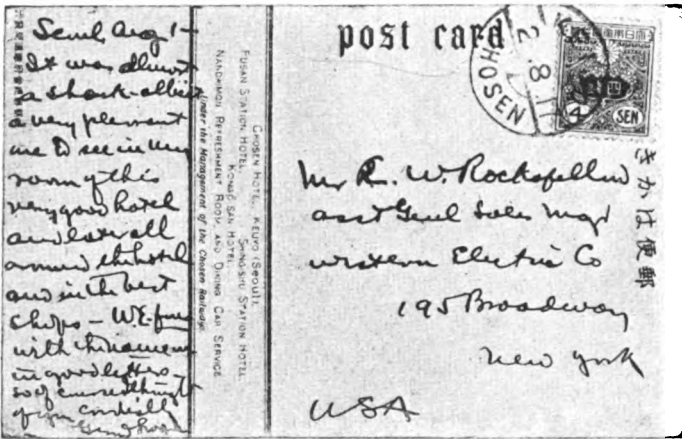

A Rough Translation of Mr. Swope's Message to Mr. Rockefeller on the Post Card Printed Above Follows—"Seoul, Aug. 1.—It was almost a shock, albeit a very pleasant one to see in my room of this very good hotel and later all around the hotel and in the best shops, W. E. fans with the name on in good letters, so of course I thought of you"



Paris House Aids the Army

What the Soldier Wants He Gets if It Can Be Found or Made by the Company

IN A LETTER written to F. H. Wilkins, who is in charge of our allied house in London, Mr. J. S. Wright, who occupies a similar position in our allied house in Paris, tells of the way he and his force of workers have been co-operating with that portion of the American Army which is now in France. Some excerpts from Mr. Wright's letter follow:

"The Paris House is in the throes of the American invasion of France. It would have been difficult to find one half-hour during any business day of this week when there was not at least one representative of the Army either in the offices or telephoning to us.

"The Signal Corps, the Engineering Corps, the Aviation Service, the Quartermaster's Department have fallen upon us, and up to the present time we have been sur-

prisingly successful in satisfying their many and diverse wants.

* * * * *

"We have had inquiries for all sorts of miscellaneous articles, many of which we have been able to furnish. To-day we have been asked to quote on sewing machines among other things, and Oastler is out this afternoon trying to find 400 pairs of linemen's gloves.

* * * * *

"I am sure you would be pleased to see for yourself what satisfactory relations we have established with the Army, and one of the most pleasing features of it all is the enthusiasm with which every member of our staff, including especially some of the foremen, have taken hold of this new business."

Hogo Bobs Up Again

He Learns Something About Elevators and Wants to Share His Knowledge

468 West Street, New York,
Part of which are office of onetime premier
Japanese Heavyweight, F. H. Leggett.

EDITOR,

WESTERN ELECTRIC JOURNAL: Which are publish account of meal dinner in which American and Japanese telephone eminences are intermingled with Geisha girls and menu.

Dearly Sir:

Other day I are visit I. Manutt (Sam E. Nutt who are popularize "Why Vacuum Repeater are Empty?" and "Where Do Honble Magnetic Influence Get Pull?").

"Hello, Hogo," he disavow, "come in." I are enter office and wait while Honble Morrison are explain that building need three more watchmen and that complaint are that elevator service are much on Honble Blink.

When Honble Morrison depart with train of attendants who are carry exhibits of new kinds of devices dear to heart of factory engineer, Manutt turn on me and say: "Hogo, have you observe that 'C' elevator car are no longer?" Honble Sir, who could fail to observe that condition? For month there have been rap, tap, tap, hammering as of something being done.

"'C' car," observe Manutt, "have honble history. 'C' car have caused more people to punch at 8:30¹/₂ and to miss 5:25 from Christopher Street than can be shook with Honble stick. Hogo, when Honble human employe of W. E. Co. Company Incorporated, are serve 15 year he get gold button of service order with one star. How like imperial order sound that, yet how possible to earn one and yet keep on right side of Honble Lansing. But when non-human employe have reached end of similar equal period it are junked into the discard or sold to jerkwater establishment a la method of reclaiming at profit greater than original cost for which Honble Hosford and Methods department at Hawthorne are always planfully working in connivance with junk Inspector of Stanley Holmes person."

"'C' car, Hogo," continue Manutt, "were many sided character, for where 'A' and 'B' are open on only one side 'C' open on two. The 'C' car were economical. On each floor were only one button for each side which save maintenance by Honble Morrison cohort followers. Again in car were one annunciator buzzer notice which serve for two sides and for up and down. If one side allright, if other ditto, if 'up' allright, if 'down' likewise. Hogo, many are time when thoughts which would otherhow have dwelt on baseball or on Honble raise, were directed to Honble chief of establishment who were responsible for 'C' car be there.

"How often are Honble Ed open door on 8-A only to hear buzz on 8-D, whereon he close on 8-A and open on 8-D which process result in someone ringing 8-A again and thus are continuous vacillation of public favor. Again person are apprised by Ed aviator that car are on way up with one truck of wood for fireplace of Honble 12th floor office of great dignitary.

"But, Hogo, all this are to change. 'C' car are no more except in name and memory and person of Honble Ed Growney. No more are Honble waiter to crane neck in endeavor to peer up or down shaft to watch evolution of car to danger of eye from obstacles kicked down by messenger seated on mail box. No more are car always go in wrong direction for all those who wish to go in other. Hogo, as I hope you understand from this elementary discourse, 'C' car are no more. It are to be succeeded by new monoplane, Liberty motor rapid climbing machine with carrying capacity like bombing plane. Hogo, 'C' car are now to be an elevator in true sense of word for both down and up service. 'C' car are to be speedy, to have lights which indicate, how it are going whether up or down or stuck between floor while Honble Ed ultimate 'Get your hahnds ahf thot gate.'"

Honble sir, at this great news I are escape from sanatorium of Honble Manutt for write you. Honble Service and Maintenance Branch are how to comfort of engineer. Strangely true. Like question, "How old are Anne woman?" come unanswerable? Why did Honble B. & M. B. depart from usual course of say with lifted eye brow: "Engineer? Who are he?" And echo answer: "How old are Anne?"

Hoping you are survive shock of no more seeing 'C' car I remain with profoundly sympathy.

T. HOGO.

Where?

Oh, where are the days that seem gone past recalling?
The days when the News gave us zest for this life,
When there was no whit of a meekness appalling,
When there was a chance for some interhouse strife.

A sadness comes o'er us—a sadness dismaying;
Our erstwhile foes seem to be feeding on pap.
For red meat—pre-Hooverite times—we are praying;
It's months since we've had a real, old-fashioned scrap.

Oh, those were the days when a chance word, fair spoken,
Would bring a rejoinder that tingled with pep,
But now—nothing doing—the old spirit's broken,
My brethren, you're fast losing all of your rep.

We've taken a part in full many a shindy;
Though verbal—yet somebody's fire they'd draw.
Can't some one start something—no matter how windy?
It's hard making bricks every month without straw.

W. A. W.

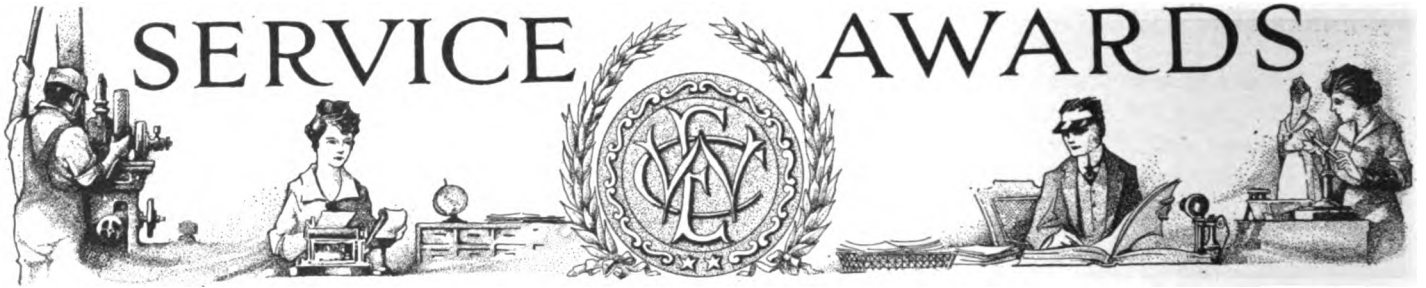

To Be Awarded in November

THIRTY YEARS		Carroll, W., Hawthorne, 6802.....	November 22
Hanson, T., Hawthorne, 7882.....	November —	Johnson, B., Hawthorne, 6460.....	" 22
TWENTY-FIVE YEARS		Yates, J. E., Hawthorne, 9803.....	" 22
Clifford, E. P., New York.....	November 14	Edens, J., Hawthorne, 6505.....	" 26
Devany, J., New York.....	" 25	TEN YEARS	
TWENTY YEARS		Brown, A. C., Hawthorne, 6961.....	November 4
Böesenberg, W. H., Chicago.....	November 5	Hochberger, E. H., Hawthorne, 6489.....	" 8
Hecht, O. E. F., Hawthorne, 5925.....	" 5	Iverson, E., Hawthorne, 5089.....	" 8
FIFTEEN YEARS		Van Dusen, R., Hawthorne, 6085.....	" 25
Wright, C. C., Hawthorne, 6161.....	November 1	Franz, B. J., Hawthorne, 5089.....	" 26
Hahn, C. O., Hawthorne, 5925.....	" 3	Schwerzler, A. J., Minneapolis.....	" 1
Kane, E. K., Hawthorne, 9858.....	" 4	Halfman, G., Minneapolis.....	" 1
Moser, P., Hawthorne, 6388.....	" 10	Bagger, F. W., Minneapolis.....	" 1
Hollinger, Mary, Hawthorne, 7586.....	" 14	Lewiston, E., Minneapolis.....	" 1
Gustave, G., Hawthorne, 6815.....	" 15	McGlone, J. J., Minneapolis.....	" 1
Heller, F. J., Hawthorne, 6844.....	" 15	Bloxham, W. D., New York.....	" 16
Elgin, G., Hawthorne, 6305.....	" 18	Davis, J. H., New York.....	" 8
McCarthy, G. D., Hawthorne, 6844.....	" 18	Graves, C. C., New York.....	" 25
Hansen, A., Hawthorne, 9859.....	" 19	Muller, O., Jr., New York.....	" 21
Morris, P. A., Hawthorne, 7155.....	" 21	Quinlan, F. D., New York.....	" 21
		Tate, R. A., New York.....	" 22
		Crantage, G. H., Philadelphia.....	" 25

Who They Are

Thomas Hanson



Along in the shivery days when the coal man gets his (which, of course, means ours) and old Lake Michigan puts on an ice coat for winter wear, the Great Lakes sailor finds himself with no more to do than a man hired to list the Kaiser's good deeds. Accordingly, late in November, 1887, Thomas Hanson, able seaman, applied for a job at the old Clinton Street Shops and was hired temporarily to help take inventory. Time must have gone very slowly in those days, for Tom, who was hired for two weeks, has been with the Company 80 years and his time isn't up yet. In fact he has almost forgotten to worry when Saturday comes around.

After stock-taking was finished Mr. Hanson was put on the job of lead taping switchboard cable. Later on, as the lead cable business grew, he was made assistant foreman of the stranding department. He has been in charge of a gang in that department ever since.

Figuring a star for every five years after the first ten, you will discover that Mr. Hansen gets a four-star button this month for his "two weeks'" service.

O. E. F. Hecht



The Clinton Street Shops were just getting going on central battery sub-sets when O. E. F. Hecht applied for a job in 1897, and was set to work assembling them. Shortly afterward he was made an inspector of sub-sets. At that time the sets were numbered consecutively before they were sent out. One of Hecht's duties was putting on the numbers and incidentally keeping records so as to know what number came next. Keeping track of the present sub-set output would make a nice little job for some ambitious lightning calculator!

Mr. Hecht went from sub-set inspection to final inspection, then to order entering, order editing and finally into the stock maintenance group, his present position.

Outside of business hours Mr. Hecht keeps himself busy working around his new home in Downers Grove, where he engineered a very successful "war garden" during the summer. Although he lays no claims to athletic ability, he holds down the first bass position in the Evangelical Church choir in true major league fashion. Besides being able to hit the low notes Ed is quite adept at reaching the high stars.



W. H. Böesenberg

Mary Hollinger

George Gustave

Bernhardt Johnson

C. O. Hahn

Walter J. Drury, Manager

5:15 P.M. Everybody still at desks working—Unusual occurrence—Evidently something awful pending.

5:20 P.M. Sound of train coming up the grade—Mad rush to the windows—Freight train.

5:23 P.M. Sound of another train—Another rush—Switch Engine.

5:28 P.M. Ditto sound—Ditto rush—Ditto Switch Engine.

5:33 P.M. Crowd greatly diminished—Sound of another train—Motor car this time.

5:54 P.M. Only the Old Guard left.—T. J. Savage, Auditor, who works out of Hawthorne, but who still belongs to Dallas, yells, "Here she comes"—Said Old Guard crowds to the windows and front dock—The "Sunshine Special" (late) passes with Mr. and Mrs. W. J. Drury on the rear modestly waving their washing in response to our wild salutations—Intense quiet as the "Sunshine" pulled over the top of the hill—A long sigh, "Another good one gone to Cleveland."

W. J. Drury



S. Z., Dallas.

The foregoing chronicle reveals better than it could be told in any other way the success which has attended the efforts of W. J. Drury, sales manager at Dallas, which he has just left after being promoted to the position of manager in our Cleveland house.

Mr. Drury has been an employee of the Company since July 5, 1904, only a week or two after his graduation from Purdue University as an electrical engineer. A year later he became identified with the sales department at Chicago, but in 1906 was transferred to the equipment engineering department.

After two years of service in that department he joined the Switchboard Sales Department, and in 1910 was sent to St. Louis as a telephone specialist. He remained there until June, 1912, when he went to Dallas as sales manager.

A Nice Distinction

Even a credit manager has feelings, so it grieved us deeply to receive a communication from one of our customers in Ohio which began thusly—"Western Electric Company, Pittsburgh, Pa., Gentlemen or Mr. Stafford."

I. B. S., Pittsburgh.

Who answered it? The gentlemen or Mr. Stafford?—Ed.



W. J. Carroll



G. A. Elgin



P. A. Morris

Other Organization Changes

The successor of Mr. Drury at Dallas is Mr. Henry P. Hess, who has been in charge of sales at Houston. He has been with the Company since July, 1905, and before entering the sales end of the Company's business worked in the engineering department. His first venture as a salesman was made in Kansas City ten years ago; a year later he went to Dallas, and in 1912 was transferred to Houston.

George L. Chesnut, who will take the place of Mr. Hess in charge of sales at Houston, has been with the Company since 1906, when he began work in Chicago. For about a year he was in the engineering department and the physical laboratory and began work as a salesman at St. Louis in October, 1907. He went to Dallas in March, 1908, and has been there ever since. Before entering the Company's service, Mr. Chesnut was with the Northwestern Telephone Exchange Co. at Minneapolis and the Michigan State Telephone Co.



H. N. Goodell

H. N. Goodell, who has been the manager of the Omaha house since 1912, has been made Assistant Central District Manager, and from now on the Minneapolis organization will report to him. He also will continue his work as manager at Omaha and will make his headquarters in the latter city.

Mr. Goodell has been on the rolls of the Company for eleven years, having begun work as a clerk in the billing and vouchering department at Chicago in 1906. His rise in that department was rapid and in 1909 he became chief clerk in Cincinnati. A few months later he returned to Chicago, where he remained until 1912, when he came to New York to engage in special studies. From New York he went to Omaha as manager.

Alfred H. Bannister, who was first employed by the company in New York in 1906, has been made sales manager at Minneapolis. He was transferred to the installation department in Chicago in 1909 and two years later went to Minneapolis, the scene of his new work. In 1913 he was sent to Omaha, where he has been since, being promoted to sales manager in March of this year.

A New Member of Our Staff

A new correspondent takes up the work of reporting the doings of the New York house in this issue of the News. He is H. P. Litchfield of the Credit Department and his picture is presented herewith. Mr. Litchfield succeeds D. Broadhurst who was drafted and is now at Camp Dix, Wrightstown, N. J.



H. P. Litchfield

Who's Who at Hawthorne



WHO furnishes the well-known prod that starts production off (and we would bet our pay-day wad he starts it with a cough)? Who tells the Shops, "Come, boys. More speed! We need three million jacks to satisfy John Hellweg's greed and keep him off our backs"? Who figures that too little said is just about enough, and what you keep

within your head won't stir up something rough? Whose name shows, plain as anything, the hook can't scare him out? (Come, hit the bulls-eye! Make it ring!) Bill Fisher. Right old scout!

See America First

It is not often that the News can offer to its readers a travelogue which covers so much ground in as few words as that from the pen of J. H. Hellweg, General Merchandise Manager, which is printed below. It sounds a little like a cross between an advertisement of the Company's cable department and a railway time table. But be that as it may, here it is:

"I am sure that I saw more reels of Western Electric cable in a recent motor trip than were ever turned out at the Hawthorne plant. This little* trip, which led our party through South Bend, Fort Wayne, Pittsburgh, Gettysburg, Washington, Baltimore, Philadelphia, Atlantic City, New York, Lee, Springfield, Worcester, Boston, Pittsfield, Albany, Schenectady, Niagara Falls, Buffalo, Erie, Cleveland, Toledo, South Bend and home, covered a district which was literally plastered with reels bearing cable in process of being installed or awaiting the arrival of installation gangs. I knew that we had been pretty busy at Hawthorne turning out cable, but I never realized what a tremendous quantity had actually been produced.

"Incidentally, it is quite an advantage on a motor trip to find distributing houses at strategic points in which are located friends of long standing. At two points I found it necessary and possible to get new casings and these absolutely without paying a cent down or writing a check. Mighty is the organization of the Western Electric Company."

* Whaddye mean, a little trip!—Ed.

Results of New Customers and New Business Contest for August, 1917

THE salesmen securing the largest number of new customers during July were:

- W. R. Phillips, Richmond
- H. L. Brooks, Chicago

The salesmen securing the highest number of points or sales to new customers for the period ending June 30th were:

- G. McCallum, Kansas City, 444 points.
- A. B. Spicer, St. Louis, 428 points.
- H. B. Stanton, Atlanta, 394 points.

Married

- July 14.—Miss Anna C. Andrews, of Philadelphia, Pa., to Edward C. Bradfield, of the installation department, now a sergeant in the First Pennsylvania Infantry at Camp Hancock, Augusta, Ga.
- August 25.—Miss Aura Mills, telephone operator at San Francisco, to Wendell Knapp, also of the San Francisco House.
- September 9.—Miss Gladys Stanley, of the San Francisco House, to Mr. H. Hill.
- September 18.—Miss Frances Wagner, department 7881, Hawthorne, to Paul Dorsch, of Chicago.
- September 29.—Miss Josephine Prehoda, of department 7398, Hawthorne, to Frank Wendt, of Chicago.

Patent Men Hold Dinner

The members of the Patent Department attended a dinner on Thursday evening, September 27, at the Hotel Astor, New York, W. P. Sidley, Vice-President and General Counsel, acting as host. Before dinner was served each guest was introduced to the host by the well-known talking dummy "Larry Know-It-All," who illustrated his remarks with pen-and-ink cartoons thrown on a screen. Mr. Sidley later addressed the men relative to the work of the department and its importance to the company.



Who's Who in the Advertising Department? Harold Whitworth of Course

TALKING IT OVER

THE FIRST AT THE FRONT

ALTHOUGH a veritable host of the Company's employees have flocked to the colors since the United States entered the world war, it has remained for a physician and a nurse to gain the distinction of being the first to reach the battle front and expose themselves to the perils of enemy shell-fire. Dr. Roderick V. Grace and Miss Jane Rignel, whose letters from a field hospital in Flanders are printed in this issue of the News, for some time have been doing their difficult and trying work at a point within range of German guns, and over which German airplanes frequently fly, dropping death-dealing bombs as mementoes of their passing.

It seems a splendid thing that the first of the Company's American workers to go under fire should be a man and a woman whose mission is one of mercy; that the Company's first representatives in the front line should be a physician and a nurse. As time goes on they will be joined by many fighting men from the Company's shops and offices, but theirs will be the honor of having been the first on the field, and not one of those who follow them will conduct himself with more bravery or quiet heroism than they have shown. Their letters make no mention of bravery—they are too busy working to think about such things as that—but it is easy to read between the lines and realize fully the extent of the sacrifice which they are making in order to relieve the suffering of the wounded. They are doing a great work in a great way.

A TRIP TO THE COUNTRY

IN taking its readers to a county fair, the News has done something a little out of its usual path, but if it has succeeded in doing it well enough to give everyone a taste of country air and a better acquaintance with the American farmer of the present day, the digression is justified. The vast majority of the Company's workers are dwellers in cities and the News hopes that the County Fair cover and article will prove of interest to them.

The modern farmer, with his automobile and other conveniences, gets into the city much more often than the city folk get out into the country, so by chaperoning its readers through the streets of a typical county fair, the News may have added a pleasing diversion to their daily routine and given them a chance to see their friend, the farmer, on his native heath.

OUR PRIZE WINNER

THE victor in our Vacation Photograph Contest is E. A. Brofos, to whose pictures, taken on the summit of the Glittertind Peak in far-off Norway, is given the place of honor on another page. The two articles specifically named in the list from which the first prize winner may choose are an electric warming pad and an electric fan. There doesn't seem to be much chance for a choice in the case of Mr. Brofos. His position on a snow-capped peak in Scandinavia surely demands that he select the warming pad. Even the Company's advertising department would find it no easy task to prove that he needed an electric fan.

NEARLY 1,000 HAVE ENLISTED

THE latest available statistics show that almost 1,000 employees of the Company—the exact number is 989—have enrolled in various branches of military service. Of this number 739 are in active service, and the remainder are under oath but have not yet been called. These figures do not include those who have been drafted because at the present time it is impossible to compute their number with a sufficient degree of accuracy. The work of assembling the National Army is still going on, and until it is completed it will be impossible to tell just how many of the Company's men have gone into the service in that manner. We wish that they could be included in our total because, like all the others, they deserve every bit of honor and recognition that it is in our power to give.

THE NEWS IS YOURS

FOLLOWING out its policy begun five years ago, the News invites its readers to help to make the magazine theirs in fact as well as name by using it as a medium for expressing their opinions on subjects of timely interest. At the top of this page appears the phrase, "Talking it Over." In this issue the editors are doing most of the talking but they don't want to continue that practice. They want the readers to have a share in the discussion on this page, and will not feel hurt or downcast if the readers of the News become interested enough to occupy every inch of the allotted space. Then this page will be really worth while.

THEY CAN'T ALWAYS WIN

OUR congratulations to Hawthorne's baseball players even if they didn't finish at the very top. Some team.

VACA PHOTO CON



HOW M.E.BERRY SPENDS
HIS VACATION.
G.H.BERRY, DEPT. 6435
HAWTHORNE.



A WATER BABY
JAMES H. McMULLEN, SALES DEPT.



— FIRST PRIZE —
TAKEN ON THE GLIT
IN NORWAY 8300 FEET
E.A.BROFOS, CHRISTIA



A HAWTHORNE SHIP THAT IS NO
MORE - THE KAYOSHK WENT DOWN
ON AUG. 25TH
C.W.SHAFFER, DEPT. 6415, HAWTHORNE.



— SECOND PRIZE —
SOME HAWTHORNE GIRLS AMONG
THE SAND DUNES
K.A.KJILDSEN, DEPT. 6966A HAWTHORNE



ONE OF THE U.S.F.
SHIP
H.B.GILMORE

ION
GRAPH
EST



BEST CATCH OF THE SEASON
MARGARET JACKSON,
DEPT, 6307 HAWTHORNE



EVEN A HAWTHORNE GIRL
LOOKS LONELY SOMETIMES.
MARGARET JACKSON, DEPT
6307, HAWTHORNE.



PRIZE —
RTIND PEAK
VE SEA LEVEL.
A, NORWAY.



— THIRD PRIZE —
NOT A SNOW SCENE - JUST THE
CAMERA CLUB'S PRESIDENT STRUGGLING
OVER THE HOT SANDS. E.H. NOWAK,
DEPT, 6966A. HAWTHORNE

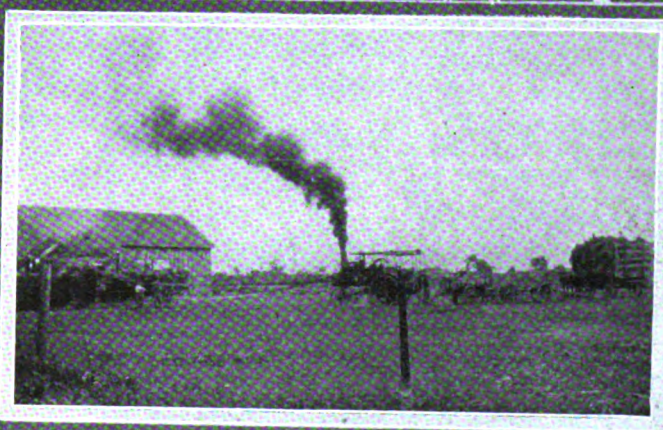

HELPING TO WIN THE WAR.
AN OHIO WHEAT FARM.
ELIZABETH M. SPONHOLZ, DEPT. 6113,
HAWTHORNE.

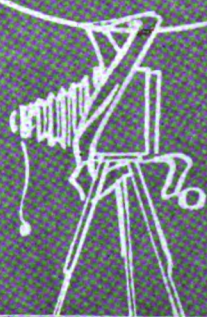

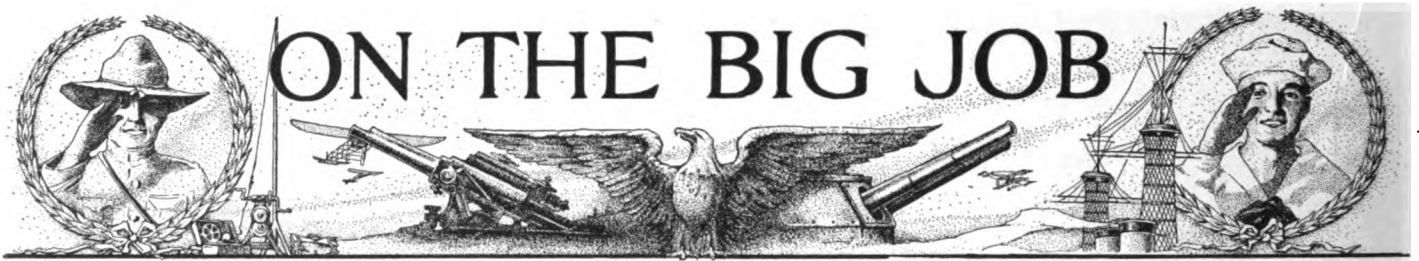

ON THE BIG JOB

Hawthorne Radio Corps Leaves for U. S. Training Camp Company Standard Presented at Farewell Exercises

“EVIL communications corrupt good manners,” observed an ancient sage, and wise old Uncle Sam, face to face with modern conditions, knows that they do more than that—they confuse good gunners. Consequently he intends to furnish his Kaiser chasers with the very best communications obtainable — which, as everybody knows, are those made in America, where the telephone and telegraph were born and reared, and the “wireless” educated. With home-made communications manned by their own expert engineers, America’s boys can talk business to the Huns and give them an unmistakable busy signal when they try to talk back.

We all know how the Western Electric Company and the telephone industries of the country at once offered to furnish the Government with a “citizenry trained and accustomed to wires,” as the late William Jennings Bryan might have put it before his political and pacifist demise. Not only did we form two radio

corps, but we started them into training against the time when Uncle Sam should need them. Last month he spoke the word for the Hawthorne company and the boys left on the 10th for further training at Fort Riley, Kansas. Before they went we all naturally wanted to say good-

bye to them and the opportunity came at a public ceremony on October 4, when a company flag made by Mrs. M. E. Kelly, of department 5789, was presented to the Corps.

At 12:15 the company, led by the Hawthorne police force and the Western Electric Band, marched through the grounds to the speakers’ stand on the athletic field, where the presentation took place. E. H. Pierce, of department 5945, introduced Mrs. Kelly, who spoke as follows: “Words fail me in trying adequately to express the pleasure it affords me to present this, their standard, to Company A, 24th Battalion, United States Radio Corps, our fellow employees of the Western Electric Company. It represents a labor of



The Radio Company's Flag



The New Flag Flies Beside the Stars and Stripes



The Farewell Parade



Vice-President H. F. Albright Bids the Boys "Good-bye"

love by an American mother, to splendid specimens of American manhood answering our country's call.

"From the first stitch I took until the last completed it, my one thought was for the success of the men it would wave above, this their emblem of orange and white—white, symbolic of light and purity; orange, the goodness of God and symbol of the radiant sun. What can follow it but victory?"

"I will address the same words to you, my friends, that I wrote to my own son 'Somewhere in France' some six or eight weeks ago:

"You will meet the inevitable in this world crisis and when you do, meet it with every drop of the good American blood that flows through your veins. Fight for humanity and democracy against autocracy, militarism and a despot that is crushing the mother hearts of the world. It may be a hard fight; it may be a long fight, but He who rules the destinies of all never yet gave us a task we could not accomplish."

"Accept this, your standard, with my blessing. Bring it back untarnished, with our flag, which has never known defeat.

"I feel I am voicing the sentiments of every man and woman present when I say: Good-bye, good luck, and God bless you."

Following the presentation of the flag, Vice President and General Superintendent H. F. Albright spoke a few words of farewell to the boys. Mr. Albright drew attention to the fact that the Company's contribution to the country has not been merely apparatus and the services of its engineers and installers at training camps and

Government headquarters, but it comprised even more—the gift of its best type of employees to serve the nation in the field.

The volunteers of the radio corps, said the speaker, were all young men who in their service for the Company had learned intelligent co-operation and the necessity of obedience to authority when big things are to be accomplished—the two prime requisites of successful soldiers. He therefore felt confident that they would give a good account of themselves in the service, showing fair play amongst themselves, good disciplined behavior and cheerful co-operative obedience toward their officers. None of their friends or relatives, said Mr. Albright, would follow their careers with more interest or with more sincere wishes for their welfare than their fellow employees at Hawthorne. The entire ceremony was an impressive one and was witnessed by a throng of the Company's employees who all were anxious to have a part in the farewell to the boys of the Radio Corps.

Seven battalions of the signal corps from the Central Department were called into training in the order that called out the Hawthorne company. No officers accompanied the men, who for the most part are employees of telephone and telegraph companies in Chicago or the area covering this division. A battalion each went to the following camps: Camp Dodge, Des Moines; Camp Custer, Battle Creek, Mich.; Camp Sherman, Chillicothe, O.; Camp Lewis, American Lake, Wash.; Camp Funston, Fort Riley, Kas.; Camp Grant, Rockford, and Camp Taylor, Louisville.



Mrs. M. E. Kelly Presents the Company Flag

Training to Trim the Teutons

A Letter from Lieut. H. S. Pratt, of the Hawthorne Radio Company, Tells of Officers' Training Camp at Fort Leavenworth

"No wonder a piece of magnet steel feels tough after hardening! We embryo warriors at the Signal Officers' Training Camp, who are being hardened to the life of a soldier, used to feel that way too at the close of a long day's tempering. However, we are now able to think of something else than our aching muscles, and it has occurred to me that the boys in the equipment engineering department at Hawthorne might like to hear how we manage to pass away the time here at Fort Leavenworth.

"Well, in the first place, we sleep—but only from ten o'clock at night until fifteen minutes to six o'clock in the morning. At that witching hour the human alarm clock cuts loose with his bugle and routs us out from under our warm woolen blankets. As one wag remarked ruefully the first morning, 'Six o'clock A. M. is no time to practice on a horn!' However, there is nothing for it but to jerk on our khaki trousers and "O. D." shirts and turn out half awake in the gray dawn in front of the barracks ready for assembly at six o'clock.

"So the 'game' begins. Next come fifteen minutes of calisthenics, followed by mess call at 6:15. After breakfast each officer must arrange his bunk and bedding in a cleanly and orderly manner, removing all dust from his section of the barracks. At 7:20 the signal sounds to 'fall in' for the first class and the work continues until 9:00 in the evening. An hour later all lights are extinguished and there is 'nothing to do till to-morrow'—that is for most of us, but occasionally some overly conscientious officer, determined to waste not even the hours spent in slumber, will sputter away in his sleep half the night, repeating commands used by the instructors the day before. Nobody bothers listening, however, unless the sleeper's dream changes and he begins to talk to 'her.' Then everyone must needs get an earful to repeat to the talkative unfortunate next day, with appropriate elaborations, of course.

"Another 'source of innocent merriment' arises when someone tries to locate his bunk in the darkness after 'taps' has sounded. There is a characteristic sequence of sounds that tells the story of such a nocturnal tragedy. Stealthy footfalls, a thud, a rattle, some very fervent though muffled remarks and we know that another ill-fated blockade runner has fallen victim to the iron cuspidors that 'mine the channel' of the barrack room. It's really a shame to laugh!

"But the boys bear bruised shins and other more serious mishaps with characteristic American pluck. In spite of the strenuous punishment incidental to the course, amounting to everything from blisters to fractured ribs, the greater majority have not even so much as absented themselves from the regular class work.



LIEUT. J.N. SHERIFF, CINN.
CAPT. P.P. BRINKMAN, HAWTHORNE.
LIEUT. H.S. PRATT, HAWTHORNE.
LIEUT. L.P. BRANSFORD, PHILA.



BUILDING A LIGHT
PONTOON BRIDGE



TRITON DID IT.



GABIONS.

"A rigorous training in horsemanship is required of those officers assigned to field battalions, and as a consequence some of the men have just about concluded that they are better qualified for the 'aviation' section due to their many successful flights from the backs of their mounts to the soft tan bark of the riding hall floor. In one instance, the officer was not only tossed from the saddle but was kicked in the seat of his trousers by the galloping horse for good measure. Some officers at the beginning experienced a very disagreeable feeling of sea-sickness from the motion of the horse and were obliged to dismount until their equilibrium had been restored. Gradually, however, we became hardened to the saddle so that now we can ride all day long in mounted maneuvers without experiencing any of the ill effects of our earlier experiments.

"I have just returned from a day's maneuver in the field as a member of a radio pack section sent out to work out a tactical problem which involved the use of two field battalions. Each field battalion consisted of a radio, an outpost and a wire company. The radio sections operated from one pack set to another over distances of about five miles, while the wire companies laid their metallic connections along the roadways by means of cable unreel from horse-drawn wire carts. The experience was very practical as it necessitated traveling about thirty miles on horseback, setting up our station at intervals along the route to keep in touch with headquarters, at which point the division commander was supposed to be directing the deployment of his troops.

"Not only must an officer master the military exercises taught at the camp but he must also prepare himself to withstand the wear and tear of field campaigns. He must be able to act as a member of a special or general court martial and form just conclusions as to the guilt or innocence of the accused. He must be technically efficient in his knowledge and operation of the telegraph, heliograph, semaphore, etc. Lastly, he must know the customs of the service and the hundred and one other things which are necessary in handling a company of men in a modern, highly organized army.

"It's a man's job and an interesting one. We are progressing rapidly and hope soon to be ready for France and another course of concentrated training with our companies there preparatory to going into real action."

All of the photographs on this and the preceding page with the exception of that at the top of page 20, and the one at the bottom of this page were taken while he was training at Fort Leavenworth, by Lieut. P. H. Olson, formerly of the Dallas House, but now of the 315th Engineers, Camp Travis, Texas. Lieut. Olson was in the midst of the last half year of his commercial course at Hawthorne when the call for officers came and he enlisted in the Reserve Corps.

THE INSTRUCTOR MAJOR WATKINS

A GOOD JOB

TRENCH WORK

SIGNAL OFFICERS IN TRAINING, XX. LIEUT. PRATT. X. CAPT. BRINKMAN

Hawthorne Hun Hunter Writes from France

Phil Bryant Gives an Interesting Account of His Experiences in Reaching the "Land Where War Is Made"

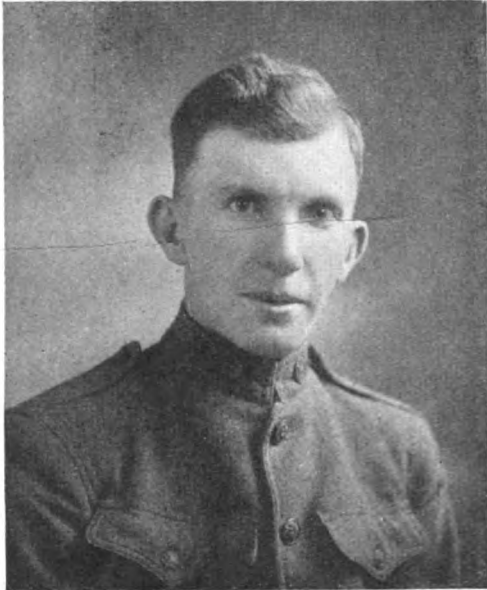

T. P. Bryant, 13th Railway Engineers

"Somewhere in France"

Sept. 2, 1917.

Since things have been published of our safe arrival, I think by this time this letter will pass the censor all right.

We arrived in New York on the morning of the 23rd, and went aboard the transport R. M. S. *Orduna*, which set sail at 8 p. m. Aboard the transport were Companies C, D, E and F of our regiment; also a company of aviators, and a medical corps.

For two days we did not know where we were going. Then, late in the afternoon of July 25th we found ourselves in the beautiful harbor of Halifax, Nova Scotia, greeted by friendly submarines and battleships. We waited here for three other transports which were to cross with our ship. Two of these transports contained railway engineers from Boston, St. Louis and Detroit. On the other transport were men from the West Indies. The ship officers would allow no one to go ashore, much to our disappointment, but they were much wiser than we, and feared German spies. It was said that the *Orduna* was one of the most hated ships on the ocean, because of her playful habit of sinking submarines.

[Aug. 1st—6.15 P. M.]

All well as the anchor is being pulled up and our transport swings into position with her sister ships. As we passed out of the harbor one of the battleship bands played the "Star Spangled Banner" and "God Save the King" in honor of America's soldier boys.

[Aug. 2nd]

Today the ocean is like glass. No land in sight, but we can see fishermen's sailboats off on the horizon occasionally. I put in my time with band practice, playing cards and reading; also life-belt drills, and body exercise during the day. I am going to bed early, because all but our stateroom lights must be out at 8 p. m., and those must be out by 10.

[August 7th]

The waves are washing the decks and tossing our good ship about like a cork. This is my first day of seasickness. It is comical, as some of the boys have the germ bad, and are sick in bed.

[Aug. 9th]

The ocean has at last quieted down and the good ship is going along like No. 11 on the Chicago & Alton. This evening off in the horizon we can see small lights flashing, which prove to be submarine chasers, our convoys. Everyone must have his life belt within arm's reach now, as we are in the heart of the danger zone. Our ship, with the rest, has been taking a zigzag course, and the chasers dart here and there like fish. They have a speed of 45 to 50 miles an hour.

[Aug. 12th]

Hurrah! Woke up in Liverpool, England, this morning. We marched ashore and boarded a waiting train for the town of Bordon. Here a band greeted our companies and marched us to Camp Bordon, two miles from the railroad station, where we rejoiced to find companies A and B awaiting us, and to have our regiment complete once more. They told us that they had been shelled by a submarine for half an hour or more, but that no great damage resulted.

Tonight we can see the flash lights searching the skies over London for raiders. I understand there was a raid in London last night and about thirty people were killed.

[Aug. 14th]

We are getting drills with gas helmets. There are two kinds of gas helmets. One is called the S. B. R. helmet or box respirator, and the other the P. H. helmet. The S. B. R. outfit has a mask that just covers the face and a box worn on the chest, which contains a can of chemicals used to "kill" the gas. The mask is also carried in this box when not in use. The P. H. helmet is in the form of a sack, which covers everything from the shoulders up. It contains a cloth saturated with chemicals. This is not very pleasant to breathe through, and makes a person rather sick at first, but you soon get used to it. The

helmets must be examined often to make sure that there are no holes in the rubber cloth, and that the valves work properly; also that the chemicals are not exhausted. Any of these defects may mean death to the wearer.

[Aug. 15th]

All up this morning at 2.45 for breakfast and then a good six-mile hike to the station, where we boarded a train for London. We arrived at Waterloo Station and marched to Wellington Barracks, where we formed in line for a parade.

The streets were thronged with people cheering, waving flags, and calling: "Oh smile, boys. Won't you smile?" "Hello Sammies," etc. One of the things that impressed me most was a group of old gentlemen with a large banner, "Old Civil War Veterans." Many of us boys gave them the glad hand. This was one of my greatest days since leaving home, as it was a high honor for a foreign armed force to parade the streets of London.

[Aug. 16th]

Our regiment left camp early this morning for an English seaport. At sunset we went aboard a captured German cattle ship used as a transport, and started for France with English torpedo boats as convoys. We

arrived at a French seaport the next morning and marched to the English barracks, where many of us were so tired we went to sleep until 10 P. M. Then we boarded a train, seven of us to a compartment, and settled down for the night. One of the boys and myself occupied the floor as a bed; two of the boys took to the side racks for bunks, and the rest took seats.

We left the next morning at 3 o'clock. All along the route the train made stops, and we were given hard tack, corn beef, jam and coffee with a shot of rum in it. We passed through many tunnels and a noted battlefield. The country is somewhat like England, but the houses and buildings are more quaint.

We arrived in this town of "Somewhere in France" at midnight. As we marched to the French barracks the people were very cordial. We have now been here fifteen days. This city at one time was in the hands of the Germans for several days. The buildings and some of the people bear marks of their dastardly work. Aeroplanes are common, and at times we can hear reports from the large guns at the front. We can hear them quite plainly today.

Weather conditions are ideal so far, and very few of the boys are sick. I am feeling fine. I am still playing in the band and stationed at headquarters.

With the Colors

Employees who have entered the various branches of the military service since the last issue of the NEWS

Sales and Distribution Departments

New York

MEIR, H. G., U. S. Marine Corps
HOFF, S. L., Aviation Section—Signal Corps
CRANDALL, R. L., National Guard
FASTENAN, F., National Guard

Chicago

ROONEY, D. J., Naval Reserve
TRENTON, J. L., Reserve Signal Corps
DES JARDIEN, P., Reserve Officers' Training Camp
WOOD, H. N., Reserve Officers' Training Camp
BLUM, W. J., Reserve Officers' Training Camp

Omaha

RYAN, R. C., Ambulance Corps

St. Louis

MEYERS, H. L., U. S. Army

Dallas

COOK, P. P., Aviation Section Training Camp

Los Angeles

WAHLIN, A., U. S. Army

Engineering Department

New York

SHREEVE, H. E., Signal Officers' Reserve Corps
HART, R. H.
LEIGH, A. H.

Manufacturing Department

Hawthorne

COOK, C. A., U. S. Army
GOODSON, R., U. S. Army
ALLEN, C. S., National Guard
TOBINSKI, J. C., National Guard
WEBB, G., Reserve Officers' Training Camp
SPURLING, G. N., British Army

Military Service Chart

← 2443 Called for Examination for National Army →

← 732 Under Oath in
either Military and
Naval Organizations →

853	830	362	398
Accepted by Local Board	Exempted for Personal Reasons	Exemption Claims not Decided	Did not pass Physically
34.9%	33.9%	14.8%	16.4%

348	183	95	106
National Guard	Signal Corps	Other Military Branches	Naval Branches
47.5%	25.1%	12.9%	14.5%

← 2045 or 83.6% Passed Physical Examination →

These Military Service Charts Are Self-Explanatory, One Noteworthy Feature Being the High Percentage of Western Electric Employees Who Passed the Rigid Government Physical Examination

Our Spanish War Veteran

That the company can boast of at least one veteran soldier on its rolls is shown by the military record of First Sergeant John L. Snyder of Company K, 47th Regiment, of the old New York National Guard. He was employed at the New York House but now is on guard duty at the Schuylkill Arsenal. Here is his record, and his picture as well.



Sergeant Snyder and His Pets

"I enlisted in Co. K., 47th Regt., N. Y. Inf., N. G. U. S., Jan. 13, 1897, and was called to the colors in March, 1898. I was sent to Camp Black, and in April of the same year was sent to Fort Adams, R. I. In October I was sent to San Juan, Porto Rico, and after one day's stay I was sent to Guayama, P. R. While at this station I was sent on several details to all the principal parts of the Island, and in March, 1898, was ordered back to New York.

"On June 19, 1916, I was called again for the Mexican would-be war, but I only got as far as Peekskill, N. Y., and it wasn't my fault that I didn't get any further. I was recalled on August 31, 1916.

"On March 31, 1917, I received a call over the phone to report for duty immediately at the Armory. I was mustered into the Federal Service on April 3, 1917."

Military Courtesies Excused

It is said that Lieutenant Gaylord, Medical Corps, U. S. A., does not believe in observing military ranks in the home. His son, B. J. Gaylord, formerly of the New York organization, is a captain in the Aviation Corps.

H. P. L., New York.

Alas, Alack!

To the Editor of the WESTERN ELECTRIC NEWS:

Dear Sir.—Honestly, Mr. Editor, do you really suppose any of our boys who have gone to France ever see copies of the WESTERN ELECTRIC NEWS? You see, the reason I want to know is that after depriving myself of my beauty sleep and wasting three hours' gas every night for the last two weeks, I have succeeded in transmitting my thoughts on paper in the shape of a poem. Now, naturally my thoughts are of some particular person (this particular person is a certain F. R. Lack, of the New York Engineering Department, who has recently left for France with our Radio Corps), and if I should find out that he never saw my poem I'd be so disappointed I'd never make another attempt at poetry.

Now, Mr. Editor, there's just one thing lacking, and that is the title, so if you can think of one that is exceedingly appropriate for my masterpiece I wish you would apply it. But please don't make it funny, as it would spoil the effect of the poem.

Hoping you will publish it in next month's News, it is as follows:

I miss you so much, now that you're away,
I find myself dreaming of you night and day;
You went when your country was asking for you,
And tho I'm proud of you, I can't help feeling blue.
Every little while I feel so lonesome,
Every little while I long for you,
I'm always dreaming, and always scheming—
Yes, and always praying for your safe return.
Every little while my heart starts aching,
Every little while I miss your smile,
Still you're just like many others—
You've gone to France to help your brothers,
But oh! I miss you every little while.

AN ENGINEERING DEPARTMENT GIRL.

Life's Little Tragedies

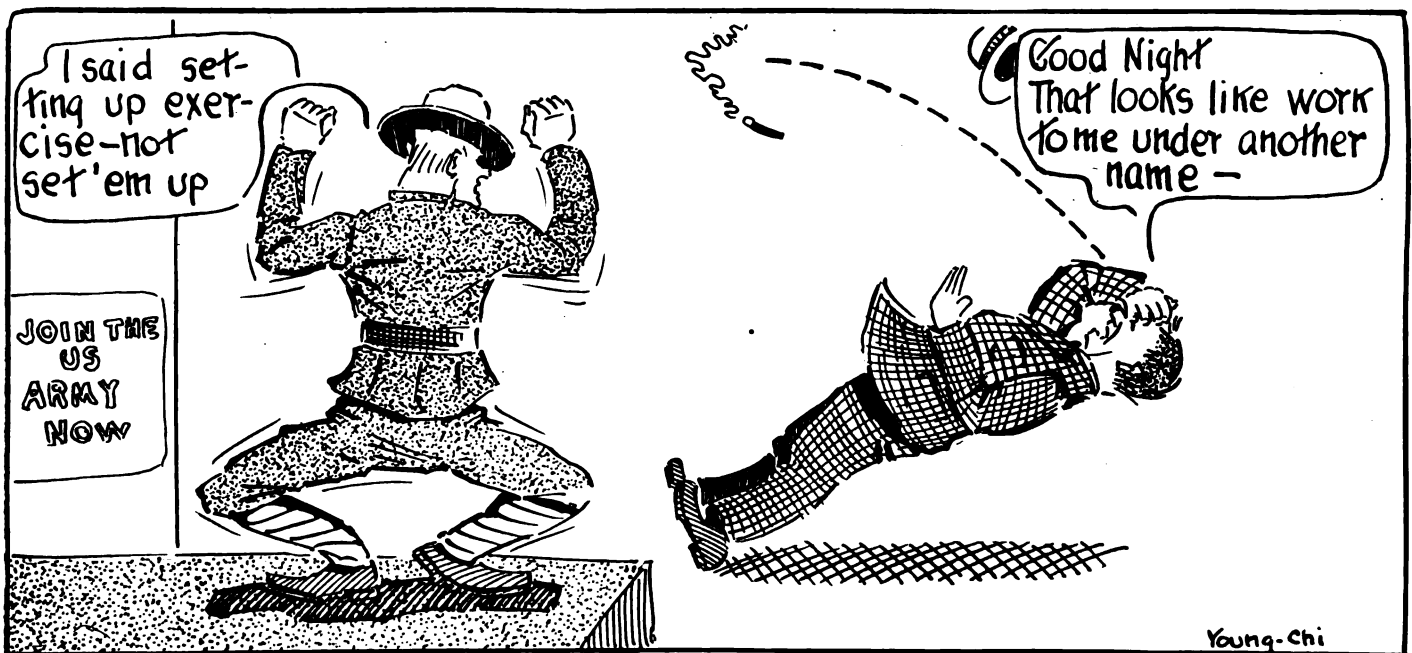

Rollo Kearsley Almost Made the Mistake of His Young Life Last Week. He Had Heard About the "Setting Up" Exercises in the Army and Decided to Enlist, But Discovered Just in Time That They Are a Fraud, As You Can't Even Buy a Drink for Yourself.

Lieut. Brehm Gets Results

E. A. Brehm, formerly of the Stores Department at Philadelphia, has been transferred to a Government position in the Ordnance Department at Washington. On August 1st he received a commission of First Lieutenant in the Equipment Division, Officers Reserve Corps. A letter from him written to Mr. O. D. Street follows:

"Just a likeness of one real soldier and one make-believe. Sergeant Slonaker, at the present time doing service in France with the 10th Engineers, was a former employee of the Bell system near Philadelphia and later connected with the Forest Service, where he insisted on being supplied with 'Western Electric Quality Products.'

"Things are progressing nicely at present and my organization is beginning to show real results. I am still expanding by leaps and bounds."



A Com and a Non Com: Lieut. Brehm and Sergeant Slonaker

News from Our Boys in the Service

Lieutenant J. W. Sheriff, formerly of our Cincinnati house, but now at the Officers' Training Camp at Fort Leavenworth, writes: "We would no doubt much rather be jack space engineering or selling Western Electric Quality Products, than arising at 5:15 A. M. and studying French, and marching madly over the surrounding hills, but the Kaiser wouldn't let us."

Lieutenant R. E. Royer of the 149th Artillery, 67th Brigade, 42nd (Rainbow) Division, formerly of the equipment engineering department at Hawthorne, writes from Camp Mills, L. I.:

"You wouldn't recognize the regiment if you compared it to last year's organization. Batteries each have 200 men, with 21 men in the B. C. Detail. Headquarters Company is enlarged to 166 men and is divided into such sections as the Photographic, Engineering, Draughting, Translating, Telephone, Wireless, Aeroplane, Signalling, etc. The new Headquarters Company has something like 14 officers connected with it, a first and two second lieutenants in each of Telephone and Wireless, three first lieutenants in Aeroplane Observing, etc. At present I am the only second lieutenant, or rather officer, in the telephone end. I have been supervising seven telephone classes for the past month; total enrollment of 110 men."

Private F. H. Ashley of the Headquarters Troop, 27th Division at Camp Wadsworth, Spartanburg, N. C., formerly an employee of our New York house, has this to say for himself:

"Have been here for the past three weeks and am getting as hard as some of the tree stumps which we have been uprooting. The weather is extremely cold at night. It went down to 42° while I was on guard last night. No chance to beat the time clock or get a half day on Saturday."

Our Atlanta house makes the following report of its contributions to the Army:

The Ninth Telegraph Battalion, Reserve Signal Corps, commanded by Major George J. Yundt, Chief Engineer of the Southern Group of Bell Companies, is now being called into active service in accordance with telegraphic instructions received from Southeastern Headquarters at Charleston, South Carolina, on Saturday, October 6.

The Western Electric Company, Atlanta, has five men, W. W. Lowery, J. C. Stepp, H. H. Hix, J. V. Weaver and O. Whitmire, who are members of this unit, and in accordance with instructions already issued they will report for duty and go into training at Camp Jackson, Columbia, South Carolina.

Lieutenants J. G. Mason and H. P. Full have been assigned to duty at Camp Gordon, Atlanta, Georgia, and Lieutenant B. Kaufman at Camp Sheridan, Montgomery, Alabama.

Pittsburgh reports the departure of two of its men, Chris. Maier, who is now at Camp Lee, Petersburg, Va., and Lawrence Linkenheimer, who also went to Camp Lee. Both received wrist watches from their fellow employees before they left.

Justin Kramer Killed at Aviation Camp

Justin Kramer, who was an inspector in the Pole Department at Asheville, N. C., but who enlisted in the Army and was sent to an aviation training camp in Canada, was killed recently. Mr. Kramer, who was 22 years old, was first sent to Fort Oglethorpe, Ga., but later was transferred with a number of other student-officers to the Canadian camp, where he met his death. He was buried in Dayton, Ohio, the home of his parents.

AFTER THE WHISTLE BLOWS



Cy Young



Dick Cantwell



Tom McGuire

PLAYING at Cleveland on Saturday, September 29, and Sunday, September 30, in the second elimination series for the world's amateur Class AA championship, the White Autos, of Cleveland, were pushed off the speedway by the Hawthorne boys.

Our team won out minus the services of five star men. Pitchers McGuire and Maager, who were taken in the draft, were at Rockford. Outfielder Kavanaugh had to remain in Chicago in readiness to report at Rockford. Outfielder Swanson had joined the navy at Grant Park, and Second Baseman Jameson, who led the team in batting, was laid up with a broken hand.

In the first game Cy Young opposed Southpaw Tommy Atkins. The Electrics hit hard through the game and outbatted the Cleveland champions, but Atkins kept the bingles scattered. The score:

Western Electric	0	0	0	1	0	0	1	0	1-3
White Autos	2	0	0	0	0	2	1	0	x-5

We Take the Second

In the second game Cantwell outpitched young Schardt and was only in danger once. In the eighth inning he walked the first two men up. A pinch hitter poled out a short single and the bases were loaded. Dick then struck out the next two men and the third man flew out to Fox. The final score was 5 to 1. The score:

Western Electric	0	0	0	0	0	1	0	2	2-5
White Autos	0	0	0	1	0	0	0	0	0-1

A Victory in the Rain

The submarine slants of Cy Young were too much for the White Autos in the third game of the series at Brookside Park, Sunday, September 30, and they went down to a 5 to 1 defeat, which eliminated them from further competition for the National Class AA Championship.

Young had the White batters popping dinky flies to the infield throughout most of the game, while our batters found little trouble in solving the delivery of Wilbur Schardt when runners were on the bases and hits meant runs.



Joy

The game was played in weather that was more suitable for football than baseball, which fact held the attendance down to about 1,500 and numbed the fingers of the athletes. Twice during the eighth inning the game was halted while rain drenched the field and spectators. The score:

Western Electrics	0	0	0	0	2	2	1	0	0-5
White Autos	0	0	1	0	0	0	0	0	0-1

Out of the Race at Last

IN THE semi-final series our boys split a double bill with the Aluminum Company of America team from New Kensington, Pa., on Saturday, October 6th. Despite the cold and the World's Series, nearly 2,500 fans turned out at Garden City Park. The visitors were forced to go ten innings to win the opener 2 to 1, but were easy in the afterpiece, 7 to 2, in seven innings. A little of Tubby Jameson's .450 batting might have swung both games our way, but Tubby is nursing a broken hand while we are nursing regrets.

The first game was a twirling battle between D. Fullerton, of the Aluminums, and Dick Cantwell, the visitor having a shade. Fullerton established a pitcher's fielding record by taking care of sixteen assists without an error. All his chances came in the regulation nine innings.

We were first to score. In the third inning Cantwell walked and was sacrificed to second by Ginners. Fox hit to D. Fullerton whose throw to C. Fullerton got Cantwell. Fox reached second on the play and scored on a hit to center by Kavanaugh. The Aluminums tied the score in the seventh inning. After Steinbrenner popped to Rehor, Kirkpatrick singled and went to third on Hurley's single. Wilson's walk filled the bases. Davis' tap to Ginners forced Wilson and Kirkpatrick scored. In the tenth inning Foster walked and was forced at second on D. Fullerton's tap to Cantwell. McCandless' two-base hit to left center scored Fullerton. This was enough to win the game. The score:

A. C. of A.....	0	0	0	0	0	0	1	0	0	1-2
Western Electric	0	0	1	0	0	0	0	0	0	0-1



Gloom

No Trouble at All

In the second game, Cy Young and Wentzel opposed each other. In the first inning Cy retired the side in order, but Wentzel was not so lucky after retiring Ginners and Evans. Kavanaugh and Fiene walked. Engelhardt was hit by a pitched ball, filling the bases. Rehor and Madigan walked, forcing in two men. Evans then tripled to the flag pole, cleaning the bases. Young flew out. Five runs scored on one hit. In the next inning Wentzel's wildness forced in two men, and if Manager Wilson had not yanked him he would have been pitching forever. C. Fullerton then went in and was fairly effective. Young was master at all times. The game was called in the seventh inning on account of darkness. The score:

A. C. of A.	0	2	0	0	0	1	0-8
Western Electric	5	2	0	0	0	0	x-7



Two Real Fans—General Superintendent H. F. Albright and Assistant General Superintendent J. W. Bancker Watch the Game

The Sad, Sad News

Chicago lost its chance to furnish half of the attraction in the final series for the national amateur championship when our crippled team dropped the deciding match of the three-game set with the Aluminum Com-

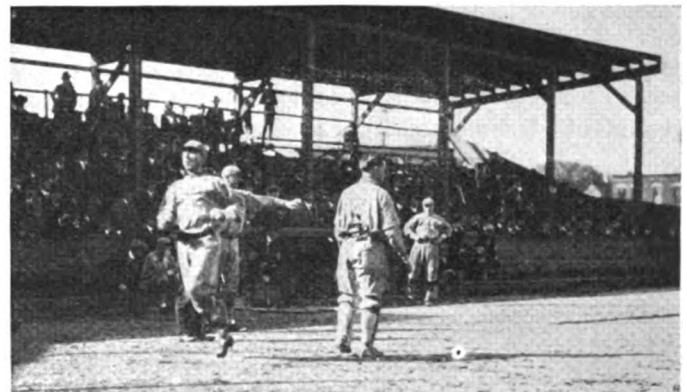

Fox Brings in Our Lone Tally

pany team, 3 to 1, after twelve innings of battling at Garden City Park. It was Kirkpatrick's home run wallop to right, with a pal on base, that short-circuited the local hopes.

Toby Fullerton, who trimmed us in the first game of the series Saturday, was the same puzzle Sunday. We counted our one and only tally on him in the first session. After that he was supreme. He stopped our boys with seven raps and did not allow as many as two to be bunched in any one inning.

Disaster befell Freddie Holdsworth's men at the outset, when Lou Fiene twisted his ankle after singling Ginners across with the first run of the game. The latter had worked Fullerton for a pass and pilfered second. In rounding first Fiene caught his spikes in the bag and watched the rest of the game from the bench.

Fullerton was responsible for the Easterners' score. With two dead in the sixth and a runner on second, he nicked Overlook for a single, which knotted the count. Reed, who went in after Fiene's injury, lost a chance

to retire the side before the tally was made by fumbling Foster's roller.

From the sixth to the twelfth session McGuire subdued the Aluminums in commendable style. He slipped slightly in the last extra chapter and walked Steinbrenner with two out. Kirkpatrick hammered one through right field and both runners had scored by the time little Bobby Madigan had tossed the ball back to the infield. The score:

A. C. of A.....	0	0	0	0	0	1	0	0	0	0	0	2-3
Western Electric.....	1	0	0	0	0	0	0	0	0	0	0	0-1



Ring Lardner Please Excuse

Hawthorne Methods Department Pitcher Describes Their Game with the Cable Plant Foremen to His Friend, John O'Brien, of the Pittsburgh House

Deer Jawn:—

Well Jawn ol kidd I was shur glad to here from you agen ol skowt an to no your the saim old kidd jess the saim as ever. Jess like you to you ol stiff you to bleeve that stuff in the augesst News about my pitchin in the Methods game agen the Plannin Pirats wich anybody O to of node it was a fraim up becaws they never got no 13 hits offen me in 4 2/3 innins like that said

becaws in the 1st plays I didn't pitch only 2 innins on acct of becaws the manigger took me out to save me fer a important game an about 10 of them hits haden O to of counted as hits any ways becaws when a pitcher dont get no support aint no reason y he O to be blaimed becaws them guys in the gardens kicks the gaim a weigh on him. So im gone to tell you all a bout this gaim myself wich we had with the Cabal Plant 4men myself befoar some other big boob doz.

In the 1st plays they wooden of beet us in the 1st plays if Craig and MacClarence that calls thereself maniggers that was maniggin us wooden of bin a pare of boobs an let em put in there own supt. in for empire an that guy Willard is alltogether to darnd big to lick you no that Jawn dont you an what chanst is a pitcher got again a empire like that spashally when them boobs of maniggers won't let a guy finish the gaim jess because they seen I was goin good the jellous boobs.

At that Jawn I haden O to of been pitchin a tall at that Jawn on acct of me havin the roomatissen sumthin fearce on acct of settin out in the swing with Elsie the uther night or mebbe it was frum settin out on the grass with Mabel Sunday but any ways it was fearce Jawn

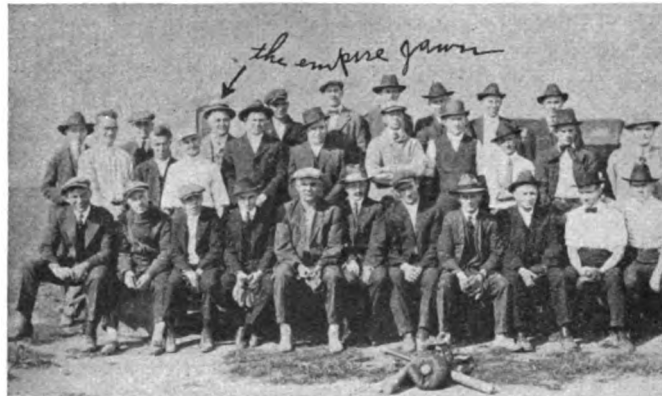

The Bunch of Rummies

take it frum me. An besides that Jawn what does them boobs of maniggers of ourn do Jawn but leeve em ring in a perfreshnal battry on me Jawn not that that guy Demicks got any thin on me Jawn you no that Jawn alrite ol kidd dont you?

Jess to show you how litle they node a bout bace ball Jawn these 1st guy up hit the 1st one I pitcht to him the big rummy insted of he O to of wayted to seen

wether I had any thin on the ball or not only mebbe he had of heard of me befoar an node how good I was wen I get goin so he diden give me no chanst to warm up the big rummy.

Our bunch diden give me no kind a support kneether like they never do wen im pitchin becaws theyed O to of nocked that guy Demick out of the bocks becaws he diden have nuthin like the stuff I had on the ball an look at what them 4men done to me all on acct of me not havin no support back of me. A course I let him strike me out a coupla times becaws gee Jawn I wason gone to run a round them baces all cribbled up with roomatissen you wooden ether Jawn huh Jawn. If it wooden of bin for that I wood of nocked out a coupla homers jess to of showed that guy up.

Say if Id of had the support that there guy got they wooden of bin nuthin to it not so mutch from his teem at that but the way that empire backed him up there O to be a law again it. One of our guys nocked a liner at the pitcher wich if Id a bin pitchin Id of cawt it but with any ordanry pitcher it O to of bin good fer a homer at lease an what do you think Willard done but stan in the way an let it hit him so we only got one bace often

it wich I call that robbry if you shoood ast me what I call that Jawn. Bleeve me Jawn wen it comes to vilatin newtralery the Germin Empire aint got nuthin on F. W. Willard empire bleeve me Jawn it aint.

I wooden of pitched a tall under them circustanzas Jawn only a bunch of the girls had came out jess a purpose to see me pitch becaws wat girl wood wunt to look at any of them other birds you no that bunch Jawn. A course I cooden distapoint the ladys an thats the reezon y they all fall for me so strong cause I no how to treet em rite an it aint only jess my good looks. Leeve it to me wen theys ladys a round. You no me Jawn with the girls hay Jawn. Wat maid me sore was that they had to stick round after I was took out out of pliteniss altho the rest of the gaim wasen worth lookin at take it frum me it was punk.

Im sendin you a pitcher we had took after the gaim. The arror points to Willard the empire wat won the gaim fer them an you kin see that with him standin back of the pitcher an coverin haff the dimon wat chanst did we have to nock a ball pass him. You can find me on acct of me bean the only good lookin guy in the bunch an onust I hated to pose with that bunch but I all ways was a good sporte you no that Jawn. Im sendin you the balks score to.

Your friend,
Ac.

P. S.—Dont show the pitcher to any girls Jawn becaws I dont wunt a lot of em riten mushy nots to me an astin fer my pitcher wich they cost me 10 sents a peas not that I mine the munny you no that Jawn. Ac.

HOSFORD'S METHODS						CABLE PLANT FOREMEN							
	AB.	R.	H.	O.	A. E.		AB.	R.	H.	O.	A. E.		
Gould, 2b.....	3	0	0	1	2	0	McKinley, 8b..	4	0	2	0	1	0
Bellamy, ss....	0	0	0	0	1	0	Graham, cf....	4	0	1	0	0	2
Thomas, ss....	3	1	1	1	3	0	Egan, c.....	4	2	3	11	0	0
Purcell, ss....	1	0	0	0	1	0	Demick, p....	4	3	3	0	5	0
St. Pere, lf....	3	0	0	3	0	0	Suckow, 2b....	2	0	0	0	0	2
Santschi, 3b...	3	0	1	1	1	1	Lawson, 2b....	2	0	1	0	1	0
Vogel, c.....	3	1	1	6	1	1	Matheson, ss..	1	0	0	0	0	0
Accola, p.....	2	0	0	2	0	*1	Bronder, ss... 2	0	1	0	1	0	
Thomas, p.....	0	0	0	0	0	6	Du Plain, ss... 1	0	0	0	6	0	
Smith, cf.....	2	1	2	0	0	0	Hottat, 1st... 4	0	2	0	0	0	
Konopasek, cf. 1	0	0	0	0	0	0	Thompson, rf.. 2	1	1	0	8	0	
Shaw, 1st....	2	1	1	5	0	0	Wright, rf....	1	0	0	0	0	
Craig, 1st....	1	0	0	2	0	0	Cada, rf.....	1	0	0	0	0	
Hernlund, rf.. 2	0	0	0	0	0	0	Du Plain, lf... 1	0	1	0	0	0	
Berles, rf....	1	0	0	0	0	1	Johnson, lf... 2	0	0	0	0	0	
							Hart, lf.....	1	0	0	0	1	1
							Kelly, scr'kpr. 2	2	0	0	10	10	
							**Willard, emp. 2	0	0	10	0	10	
Total	27	4	6	21	9	4	Total	88	8	15	21	28	26

* Rottin scorin Jawn that shooden of bin called a error a tall but the score keeper had it in fer me an jess becaws I dropt that one wich anybuddy wood of dun he goes an marks it a error. Purty raw hay Jawn.

** That's all rite to have him in there line-up Jawn cause he won the gaim fer them at that like I told you.

SCORE BY INNINGS.

							R. H. E.
Methods	1	0	0	3	0	0	0-4 6 4
Foremen	0	0	1	1	3	1	2-8 15 26



The Burnt Child, Etc.

A communication written on Company stationery has found its way to the desk of the Editor of the News, and an inspection of it reveals the fact that it deals entirely with an important phase of the Company's business, the late unpleasantness between the Giants and the White Sox. It contained the following gem of thought which is deemed worthy of perpetuation in the columns of the News.

"I quit betting a good many years ago—ever since I bet on a horse at twenty to one that came in at quarter to six."

The signature affixed to this explanation of the conscientious scruples which would not permit the writer to bet upon the chances of the White Sox (probably he now wishes that he had) consisted of the initials "A. H. H.," and the communication bears evidence of having come from the accounting department at Hawthorne.

The Team on the Right Represents the San Francisco House in the Bay Cities Commercial League. In the Picture They Have a Loving Cup for which, According to our Correspondent, they Played at Santa Cruz. He Doesn't Say Whether or Not They Won It.

Pittsburgh's First Picnic

The employees of the Pittsburgh House have succumbed to the picnic habit and all went out to Linden Grove where a baseball game was one of the chief events of a perfect day. A vivid description of said game has been furnished by the Pittsburgh correspondent of the News. It follows:

"The ball game between Pat Jones' shop team, captained by Costello, and Captain Joe Jaques' combined Stores and Sales Department team, was won easily by the Shop team in seven innings, the score being 7 to 4. Captain Jaques' team was evidently afflicted with the same disease as Dreyfuss' Pirates. They lacked the punch in the hitting department. Captain Costello's men produced a hit when needed. The teams and all spectators were disappointed when James Grundy, who was advertised to umpire, failed to appear. Jim Kleg was persuaded to umpire, and no person envied his position. Jim's size saved him from any violence, as he was frequently 'in Dutch' by his decisions, which were not strictly in accordance with 1917 rules."



Our Cub Does a Dub Job Reporting the Third Annual Tennis Tournament at the Cable Plant

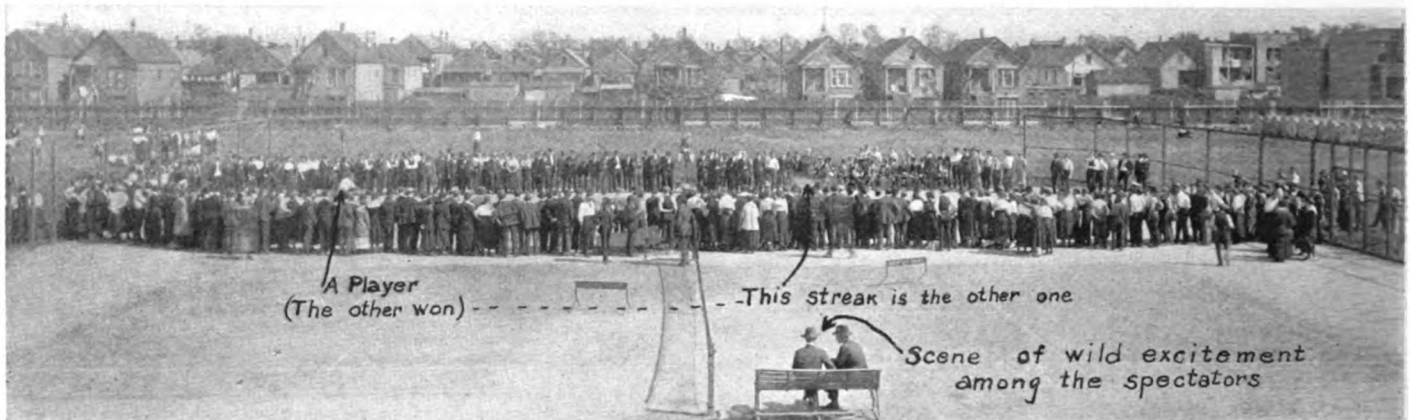

The Final Match: Get a Microscope and You Will be Able to See the Ball.

“THAT sounds like Lucy’s ring” remarked our cub reporter as he grabbed for his telephone. Lucy calls him up frequently. She is his fiancée, and he knows her ring, (although lots of people can’t tell it from a *real* diamond.)

A moment later he set the ’phone down again, but in that short space all the joy had gone out of life. “Heck!” he remarked dejectedly. “Doggone it all! A fellow from the Cable Plant just called up and he wants me to come over this noon and write up the finals of their annual tennis tournament. Heck! And I hate to watch tennis.”

“Oh, that’s all right,” we reassured him. “You won’t see any tennis at a Cable Plant tennis tournament.”

“I don’t suppose any of the girls turn out, do they?” he ventured half hopefully.

“Do they!” we repeated meaningly. “Say, while you are supposing, suppose you go and see.”

He did, and came back whistling like a peanut cart. It seems he had got a chance to talk to a lot of the pretty girls over there by asking them to pose for a group picture. Later, as an after-thought, he also took a picture of the game, in which you can almost see the players. But then, maybe you’d rather see the girls, anyway. They are extremely easy on the eyes. Yes, indeed! And just to show you how careful we are of that cub, we’ve decided to report next year’s tournament ourselves. He’s a good boy, but young, and posing all of those pretty girls ought to be the work of an older—or let’s not say “older”; suppose we put it, “of a more mature” man.

Meanwhile, just to show that the ladies had not completely turned his head, the cub handed in the following write-up of the tournament. Or perhaps the write-up proves they had one. Anyway, here it is:



There is One Good Thing About Those Cable Plant Tennis Tournaments, Anyway—They Give Us a Chance to Run a Picture of Some of the Good-Looking Fans

September 28th was a beautiful day, and the setting for the great match was complete. There was a tall bench for the umpire to sit on, and the players had on white suits and handkerchiefs around their heads and everything, just like a regular match. The contestants were: Hugo Wermine, of the Chemical Methods Department and M. D. Hayes, of the Manufacturing Methods Department.

The crowd surpassed all expectations. It is estimated that every one of the 1,500 employees of the Cable Plant was present with the exception of 1,200. It became necessary to double the police force generally em-

ployed to take care of the throngs that turn out for these annual events, and it was all both of them could do to hold the crowd in check. Fear that perhaps some outsiders might have slipped in led the committee to take special precautions to guard against disreputable characters. C. E. Jahn and Charlie Kosar were among those present.

The Western Electric Band was on hand with instructions to crash forth every time Doc. Hayes lost a point, as there were ladies present. The band boys certainly earned their money. Wermine won in straight sets, 6-0, 6-2. The report of previous catastrophes follows:

Outline of Matches

Hottat (+ 15)	Hottat	} Hottat	} Craig	} Hayes	} Hayes (Default)
Abbott (+ 1/2 15)	Berger				
Berger (+ 30)	Craig	} Craig	} Denny (Default)	} Wermine	} Wermine
Bye	Pinnau				
Craig (- 1/2 40)	Hayes	} Hayes	} Wermine	} Wermine	} Wermine
Kodatt (+ 30)	Lundgren				
Pinnau (+ 30)	Tarmon	} Tarmon	} Wermine	} Wermine	} Wermine
Bye	Alberts				
Roberts (+ 1/2 15)	Johnson	} O'Brien	} Lilly	} Wermine	} Wermine
Hayes (- 15)	O'Brien				
Lundgren (0)	Fauquier	} Lilly	} Denny (Default)	} Wermine	} Wermine
Bye	Lilly				
Tarmon (- 1/2 15)	A. B. Brown	} Denny	} Wermine	} Wermine	} Wermine
Bye	Denny				
Alberts (+ 15)	Lamplough	} Lamplough	} Wermine	} Wermine	} Wermine
Bye	Jones				
Johnson (- 30)	Hart	} Hart	} Knoke	} Wermine	} Wermine
Bye	Jordt				
O'Brien (+ 1/2 30)	Knoke	} Knoke	} Wermine	} Wermine	} Wermine
Bye	Heyer				
Fauquier (0)	Smaus	} Smaus	} Wermine	} Wermine	} Wermine
Bye	Bowman				
Lilly (- 1/2 40)	Ulrick	} Wermine	} Wermine	} Wermine	} Wermine
Bye	Wermine				
A. B. Brown (+ 30)	Dahl	} Hanna	} Wermine	} Wermine	} Wermine
Bye	Hanna				
Denny (+ 30)	Latane	} Latane	} Wermine	} Wermine	} Wermine
Bye	Wright				
Lamplough (- 30)	Hall	} Reed	} Rutherford (Default)	} Wermine	} Wermine
Bye	Reed				
Jones (0)	Markuson	} Rutherford	} Wermine	} Wermine	} Wermine
Bye	Rutherford				
Hart (- 30)					
Jordt (+ 30)					
Vrehl (+ 30)					
Knoke (+ 15)					
Bye					
Heyer (0)					
Bye					
Smaus (+ 1/2 30)					
Bye					
Bowman (+ 30)					
Bye					
Ulrick (+ 1/2 15)					
Bye					
Wermine (+ 15)					
Bye					
Dahl (- 30)					
Bye					
Hanna (+ 1/2 30)					
Bye					
Latane (- 40)					
Bye					
Wright (+ 15)					
Bye					
Hall (+ 15)					
Bye					
Reed (+ 30)					
Bye					
Markuson (0)					
Bye					
Rutherford (+ 15)					
Bye					

Golf

THE main event during September for the golf players was the challenge round to determine the challenger for the championship held by Mr. Rautenbusch. This was a match play event without handicaps. A qualifying round was played September 8th, the low sixteen players winning places in the challenge flight, tabulated results of which are shown below.

Mr. Muller will play a thirty-six hole match with Mr. Rautenbusch for the title. A Consolation flight for those

who failed to qualify in the championship round was played off during the month, F. F. Heppe defeating D. Levinger 3 and 2 in the final round.

The annual outing on Sunday, September 30th, at the La Grange Country Club, was played under adverse weather conditions, which made good scores impossible, but the peevishness of the players over their poor playing was forgotten when they gathered around the table for a fine chicken dinner, served by the La Grange Club.

First Round	Second Round	Semi-finals	Final
J. F. Grosvenor R. D. Jessup	R. D. Jessup 4 and 3	F. A. Mueller By default	F. A. Mueller 6 and 5
F. A. Mueller F. B. Longfellow	F. A. Mueller 3 and 2		
W. A. Titus W. C. Hazleton	W. C. Hazleton 2 and 1	P. E. Kern By default	F. A. Mueller 1 up
E. J. Darrenougue P. E. Kern	P. E. Kern Forfeit		
C. A. Hach J. Carr	C. A. Hatch 4 and 3	H. C. Beasley 3 and 1	R. W. Kuhnle 1 up
H. C. Beasley J. C. Vanselow	H. C. Beasley Forfeit		
J. P. C. Hennessey O. Anderson	J. P. C. Hennessey 1 up	R. W. Kuhnle 4 and 3	
E. G. Brown R. W. Kuhnle	R. W. Kuhnle 6 and 5		



Bowling

RIP VAN WINKLE once enjoyed a long sleep at a bowling game, but then, as the old song states, "Rip Van Winkle was a lucky man." The boys in the Hawthorne Bowling League declare that they can't even so much as nod this season without some other team nosing them out of first place, and the score of the first 12 games proves the statement. It shows four of the six teams tied for premier honors. That ought to mean a very interesting season.

The opening night was September 30 and the finale will come on April 18, making a 30 nights' schedule. All the games will be rolled on Crouse's Alleys, 22nd Street and 56th Avenue, on Thursday evenings.

Big Bill Teichtler is chairman of the league; A. Higgins, secretary, and F. B. Wilkerson, treasurer. Six teams are entered: Machine Departments, J. Larson, captain; Technical Departments, O. Jenkins, captain; Inspection Departments, G. Rude, captain; Production

Departments, A. Higgins, captain; C. R. & I. Shops, G. Preble, captain; Engineering and Switchboard Departments, F. B. Wilkerson, captain.

The bowlers says they have not hit their stride yet, but most of them seem to be going pretty well, at that. Jenkins hung up a score of 266 one evening, just to give the boys something to shoot at. That is not half bad for early season rolling. At that rate 300 scores will be common later on. Watch the score boards. The standing of the teams at press date follows:

Team	Won	Lost	Total Pins for Night	Total Pins for Season	Average
Production	7	5	2524	10175	847 11/12
Technical	7	5	2568	10167	847 8/12
Machine and Jobbing.	7	5	2485	10085	840 5/12
Inspect. and Assem...	7	5	2545	9781	815 1/12
Swbd. and Eng.....	5	7	2466	9855	821 8/12
C. R. & I. Shops.....	3	9	2320	9810	775 10/12

High game for season—Production, 1026

High average for season—Production, 931 1/3

Western Electric News





A GIFT THAT WILL HELP

Red Cross Chapters have material in abundance, but they lack machines to keep willing workers busy. You will be doing a real service if you give a

Western Electric Portable Sewing Machine

It is appropriate for the work—no larger than a typewriter, and can be carried home after a day's work at your local headquarters. It works faster and more easily, for electricity runs it. Your Red Cross Chapter needs it *now*. Costs only \$35.00 (\$37.00 west of the Rockies), less than most of the well-known makes of treadle-power machines.

**WESTERN
ELECTRIC
COMPANY**
Inc.

Gentlemen:

Please send me Booklet
No. 522-RC, describing your port-
able electric sewing machine.

Name _____

Address _____

If your lighting company or electrical dealer cannot show you this new kind of sewing machine, write to our nearest office for booklet No. 522-RC.

WESTERN ELECTRIC COMPANY, Inc.

New York Chicago
Kansas City San Francisco
Houses in all Principal Cities

This advertisement appears in the December number of the Red Cross Magazine

Western Electric News



H. B. Thayer, *President*; H. A. Halligan, *Vice-President*; W. P. Sidley, *Vice-President and General Counsel*; A. L. Salt, *Vice-President and General Purchasing Agent*; Gerard Swope, *Vice-President and General Sales Manager*; H. F. Albright, *Vice-President and General Superintendent*; J. W. Johnston, *Treasurer*; F. B. Jewett, *Chief Engineer*; G. C. Pratt, *Secretary*; R. H. Gregory, *Comptroller*; C. E. Scribner, *Consulting Engineer*

Office of publication and address of President, Secretary, and Treasurer, 195 Broadway, New York City

BOARD OF EDITORS

P. L. Thomson, *Editor-in-Chief*

W. F. Hendry S. S. Holmes E. C. Estep F. W. Willard W. E. Leigh William Jabine H. D. Agnew Reed Calvin S. W. Murkland

Subscription: \$1.50 per year, except to employees of the Western Electric Company, to whom copies are furnished free of charge.

All communications and contributions should be addressed to WESTERN ELECTRIC NEWS, 195 BROADWAY, NEW YORK.

Matter intended for any given issue must reach New York not later than the 12th of the preceding month.

VOLUME VI

DECEMBER, 1917

NUMBER 10

Belgium Under German Rule

A Story by C. C. Clayton and A. D. Whipple in Which they Describe the Conditions Behind the German Lines and Tell of Some of their Experiences



C. C. Clayton

SO much has been said and written about the earlier days of the war in Belgium, that we propose to commence our narrative with a description of how we found things when we returned after the city had been bombarded by the German Army and occupied by them on October 9, 1914. We had been in Antwerp during part of the bombardment and had joined the Belgians in their flight from the city, which was like the exodus of

a people, an experience which one can never forget.

What a transformation, thought we, as we tramped into Antwerp again on the afternoon of October 14, 1914. A week before, it was a city of half a million in feverish activity: the hotels and restaurants crowded with excited diners, the cafés buzzing with discussions of the latest news, automobiles and ambulances dashing through the streets, everywhere the stocky Belgian soldiers in their long blue overcoats, with here and there a few of the British marines who had come to save us, and above all the roar of the cannon at the outer defences, by its continuity lending support to the reports of the Belgian General Staff, that "all goes well." As late as

October 6, the people generally were wondering whether the famous fortress would be able to hold out indefinitely, or would be obliged to surrender in a year or so, if attacked persistently.

Now, we were at the gates of a city which was but a skeleton. It gave the impression of abandonment like that given by the grounds and buildings of a great university in vacation time, or a summer resort in mid-winter. Now and then we encountered a few civilians or a few stolid, heavy Germans in gray, instead of those light-hearted Belgians in blue, whom we had seen there only a week before. Here and there was an abandoned cat or dog searching food. Houses, shops and restaurants were nearly all closed. No street cars, no lights, no water. Here, smoking ruins, as illustrated by the accompanying photographs. Yonder, other houses with interiors exposed by fallen walls or with the whole contents jumbled inextricably in the basement. Such was the desolation that we and a few other strangers encountered on returning to the city made German five days before.



A. D. Whipple

The homes and affairs of the refugees had to be taken care of in some way, and consequently the question arose at once as to what advice should be given to those who had fled to Holland. The Belgian authorities hesitated because the people, by remaining in Holland, were at least free. The majority feared to return on account of the atrocities committed elsewhere by the Germans, thinking that if they escaped personal violence they might perhaps be incorporated into the German Army, or be required to work against their own country.



The Antwerp Cathedral Looms Up Over a Waste of Shattered Masonry

The Value of German Promises

The Germans wished them to return, and besought the Belgian authorities to induce them to do so. The result of these discussions, between the Belgian and German authorities, was that the Governor General, von der Goltz, and the Military Governor of the Province of Antwerp, von Heune, gave written guarantees to Mayor De Vos, to President Franck of the Interborough Council, to Cardinal Mercier, and to the Dutch Consul General that the Belgians would be left undisturbed in the pursuit of their usual occupations, and that they would not be required to perform any military service nor be forced to work for the Germans.

Under these guarantees, many were induced to return during the following months. Let us think for a moment of those who had been away without news and returned with their bundles to find only the ruins of what used to be their homes. As is well known, the Germans repudiated all of their promises and written guarantees two years later, when they forcibly deported the Belgians by the thousand and compelled them to work in Germany, thereby releasing for other purposes an equal number of Germans. To the eloquent protests of the Belgians to whom the guarantees had been given, the Germans replied that conditions had changed in two years, that the laboring class was losing its habit of work, and that it was good for them to go to Germany to work.

We saw this deportation of the young men from Antwerp. They received short notice to appear at the railroad station, prepared to depart. For days that part of the city was full of them, accompanied to the station by their mothers, wives, brothers and sisters. Sickness

and weakness were often no reason for exception, and they were loaded into trains, in many cases into freight cars. They frequently remained four or five days continuously in those trains, under military guard and without food. Their treatment was intended to compel them to sign a contract to work for the Germans, and that of those who refused to sign was beyond description. They were deprived

almost entirely of food, of protection from the winter weather, of medical attendance, and at the same time subjected to indignities that only a German officer knows how to inflict.

Many of them died there; some died in the train during the return trip. Others came back tubercular, with rheumatism, or in such an emaciated condition that their health was permanently injured. They had refused to sign, and their condition had become such that they were a burden to the Germans, so they returned them. We have seen them returned and released by the Germans in such condition that they were scarcely recognizable by their waiting relatives, who found it necessary almost to carry them to a hospital in order to save them. Some of the young men were employees of our Company; they all were human beings like the rest of us. Their refusal to sign, in spite of their maltreatment and suffering, gives us a rare example of fortitude and courage.

A Commission for Everything

Observing the development of the German organization for governing Belgium was very interesting. The Governor General delegated authority to Military Governors of Provinces and to Presidents of the Civil Administration in each Province. Commissioners and Controllers, almost innumerable, were appointed. For example, there was one for Police, one for banks, one for taxes, one for coal, one for grain, one for sugar, one for potatoes, one for butter, etc., almost without end. In fact, the daily life of everyone was regulated by German control to such an extent that to do anything unusual was inviting trouble. A Swiss friend of ours wished to send a small dog to his sister in Hamburg, and he devoted all of his time for three days to the details preliminary to shipment.

As all means of communication in Belgium were the property of the state, all such services ceased with the

departure of the Belgian Government. It is the general opinion that the Germans showed exceptional capability in the re-establishment of communications, but necessarily the work required some time. In the early days of the occupation, one travelled on foot, by canal, by cart, carriage or coach. The journey of 27 miles from Antwerp to Brussels, which was formerly a matter of 35 minutes, was made under these primitive conditions in five or six hours. Now, by the best military trains, the trip is made in one hour and ten minutes.

The Postal service is operated by the former Belgian employees, under German direction, and gives fairly good service in the territory under the Governor General. All letters must be posted unsealed, and pass through the German Censor. Telephone service is permitted only to German Military and Civil authorities. The public may, however, use the Telegraph service in Belgium and the territory of the Central Powers.

Industry, in general, is at a standstill. Anyone who wishes to employ labor or power must be authorized to do so by German authority, and the authorizations are granted only when so doing will serve German interests. When an industry works, some crumbs of benefit may fall to the Belgians but it is safe to say that it is working for the Germans, that is, disloyally. In most instances, however, manufacturing is physically impos-

sible because the raw materials have been taken almost to the last pound. In addition to this, all machinery useful in war industries has been carried to Germany. Motors, belts, and transmission machinery have gone the same way. In many cases what machinery they could not use had to be dismantled for the copper, because everyone having copper or brass or tin was obliged to deliver it to the German authorities. Under such conditions, work is generally impossible.

Food is the Greatest Need

Public works, which the Belgians would like to carry on, are also forbidden by the Germans unless in their interest, so that there is no means of providing work for the great mass of the laboring class, and the local Belgian governments are piling up huge debts to provide food, clothing and heat for them and their families.

The food problem has assumed a place of paramount importance in Belgium ever since the German occupation.

Thousands of the people exist on what they obtain once a day from the soup kitchens and restaurants, which are operated by committees under the auspices of the Relief Commission. It will be remembered, no doubt, that the Germans never did anything toward providing for the civil population of Belgium and Northern France. The Commission idea was conceived by Americans and the work organized as the American Commission for Relief in Belgium. Later the scope of the work and the organization were changed, and ultimately it became in this country largely a Government institution. Because they recognized this problem at once and found a satisfactory solution in the Commission for Relief, the Americans have won the everlasting gratitude and respect of the Belgian people. It was unquestionably the work of Mr. Hoover and his staff which prevented the food and clothing sent to Belgium from falling into the hands of the Germans. This complete control of the Commission

for Relief of all importations and the efficient methods of distribution which they organized have, without doubt, saved the Belgians in Belgium from starvation.

The Commission for Relief is still providing for them and it is the constant fear of the Belgians that something may happen to stop the supply. They are firmly convinced, and it is probably true, that if this splendid work should cease, many of them would

starve before this winter has passed. When we left, they implored us to give to all Americans their message of gratitude for what has been done, and to make known the fact that they are hungry.

As a result of this wonderful work of the Commission for Relief, all Americans have the highest possible reputation in Belgium for efficiency and integrity. When the time comes for peace and reconstruction, the Belgians will look largely to the Americans to help them solve problems which will be far greater and more difficult. Let us hope that we will not be found wanting when they then seek our assistance.

The Commission for Relief was able to prevent the Germans from taking what was imported into Belgium but they could not prevent them from systematically breaking their formal agreement not to take the local products, except when in excess of the local requirements. In reality, the Germans take nearly all of the local



Havoc Wrought by German Shells in the Rue de Peuple, a Prominent Street of Antwerp

products and the Belgians have only what is sent to them. The great majority of the people have become thin and weak on account of insufficient nourishment. There is a great deal of sickness, and the death rate is very high. Last winter, during a cold spell of six or seven weeks, there were thousands who remained twenty hours out of the twenty-four in bed. They got up before noon to go for their dinners at the Committee restaurants and then returned, after their one meal for the day, in order to keep from freezing to death.

In addition to what one obtained from the committees, it was usually possible to buy in the shops many things with which to supplement the rations. The prices of these things, however, which frequently had been smuggled into the city, were so high that comparatively few people could afford to buy them. The prices current when we left were as follows, in dollars per pound: Sugar, 90c; coffee, \$4.50 to \$5.00; tea, \$9.00; cocoa, \$4.50; rice, \$1.50; beef, \$1.30 to \$1.50; butter, \$2.50; bacon, \$2.75 to \$3.00; milk, which was half water, 20c per quart; condensed milk, \$1.30 per can; eggs, \$1.55 to \$1.60 per dozen, and potatoes, \$9.00 to \$13.00 per bushel.

Doing Business With the Germans

One cannot appreciate the conditions prevailing in Belgium without some understanding of the methods of the German Government, and in order to illustrate them we propose to give you a brief outline of some of our dealings with several departments of the Government. We probably had more to do with them than anyone else in Antwerp and although, in general, the Germans have confidence in no one and are suspicious of everyone, we probably had more of their confidence than almost anyone else there.

We had devoted considerable time in endeavoring to transfer ourselves from conditions of peace to conditions of war, and to acquiring the best understanding possible of the new conditions in Belgium because we knew that sooner or later the Germans would investigate our affairs. Our first encounter was precipitated by our demand for permission to ship to Holland some of the large quantity of piece parts and tools which were so badly needed for the automatic telephone apparatus previously manufactured at Antwerp. Before making a decision they

summoned us before a commission headed by the President of the Civil Administration of the Province. They had prepared in advance a list of subjects and questions which they used as the basis of their cross-examination. That list included questions about the work we had done for the Belgian Government during the first two months of the war, whether or not we had made ammunition for the Belgian Government, what we had done toward making coins for them, what had become of the managers and members of the Board of Directors, what credentials we had in order to prove ourselves the authorized representatives of the company, our banking arrangements, etc., through a list of the rumors and reports which they had been able to collect. Many times we were on very thin ice but we pulled through the session, which lasted an entire afternoon.

In dealing with the Germans, we found them egotistical, bursting with a sense of their own importance, and determined to terrorize whenever possible. We found also, however, that it was possible to call their bluff, and did so on frequent occasions, of which

the following will suffice as illustrations.

In July, 1916, an order of the German Government made it necessary to declare our stocks of brass and copper, in special sections, which were still on hand. The declaration was made and shortly afterward the Government asked if we would agree to sell to them. We replied that we never agreed to sell anything without knowing what we were going to receive for it, and asked what they proposed to pay. After some correspondence about that point, they finally made us an offer which amounted to about \$7,000 for the goods in question. We calculated that on the basis of what they had cost before the war, plus warehouse expenses and interest on our investment, their value to the company was at least \$13,000, and refused to accept their offer. They then sent us expropriation papers and told us that we must ship the goods, paying the cost of packing and transportation to the German frontier, and that a receipt or requisition paper would be sent to us. We told them that we could not follow those instructions because we were short of money and could not spend any for nothing. They replied that if the goods were not shipped by a certain date, the matter would be turned over to the military authorities who would take it away at our



A Shot That Came Too Close for Comfort. The Building on the Right Is Part of the Antwerp Factory

expense and not even give us a receipt. We then went to Brussels and called on the head man of the department which was handling the matter for the Government. He said there was nothing that could be done, as the prices were fixed by the Government, and that unless we accepted the offer of half of what the goods were worth we would lose them anyway and receive nothing—not even a receipt to show that they had been taken.

Calling the Teutonic Bluff

When he had finished his explanation of the situation, we told him that we wished to make clear our contention. We said, "We know that you can take the goods from us by force or steal them and that we can not stop you, but we want you to know that if you do, we will make a row and a protest which will be heard from Washington to Berlin. The correspondence shows," we said, "that we are disposed to sell the goods without profit and that we simply ask to prevent a loss. What you propose is the confiscation of private property, and we will so report it to the American Government." Our bluff worked and we received \$14,000 cash for the goods.

At one time, another department of the German Government had machines loaded on wagons in our driveway, and proposed to take them away before they had furnished the proper receipts or requisition papers. We told them that they were not following the orders of their own Government and that they could not take the machines until the receipts were in order. They said they were going to take them out anyway and would come the next day with the papers. We knew their habit of saying this and never returning, so we stepped in front of the wagons and told them that we did not ask special consideration, but refused to let them go until the laws of their Government had been complied with. They threatened to throw us out of the way and take them anyway. We said, "You have a dozen or more soldiers here and you can do that, but, if you do, we will protest

to your Government, because you are not following their published orders." In the end, they thought better of it and went away with their horses. The next day they returned with the official receipts in order, and we had no further trouble with that department. Many people, however, had things taken from them in that way and never received anything, because they could not trace those who had virtually stolen their goods.

All of our observations and dealings with the Government proved, as in these cases, that with them there was no such thing as justice and that nothing could be right unless it was in their interest and for the good of Germany. Familiarity with their acts and a study of their motives must drive one to the conclusion that they are unmoral. They may know the difference between right and wrong, but they neither love the one nor hate the other. They will abandon truth and honor without a regret if so doing serves their end. Their success is the necessity that knows no law. Generally, we found this to be the philosophy of the individual as well as of the Government.

To illustrate the mentality of the Germans, let us tell you about conversations with two of them who were prominent in the Government at Antwerp. It was shortly after the Lusitania was sunk. At that time the Germans thought a great deal about the possibility of the United States joining the Allies, and these two men expressed separately about the same point of view, which was this: They said they would like to see the United States come into the War, but thought the Americans had better sense and would remain neutral so that they could continue to make money. We asked them to tell us why they wanted to see the United States come in and they replied, "It will shorten the War," and upon request they gave the following explanation: "If the United States comes in, we will be able to carry on unrestricted submarine warfare, and we will be able to blockade England. We know that we can make a separate



A Railroad Wreck in the Outskirts of Antwerp. The Germans Loaded a Train With Gravel and Explosives and Turned It Loose on the Line Running Into Antwerp. Here Is Where Its Mad Race Ended

peace with Russia, and we will do so. We will then bring troops from the East to the West, and beat France. By that time, England will be blockaded and will be unable to carry on the War alone, so will have to ask for peace. We will then form a fleet consisting of our own fleet and the fleets of our present enemies, take troops with us, go to the United States, and compel them to pay all of the expenses of the War. They are the people who have made all of the money and they must be the ones who will have to pay for it." Sayings of that kind should impress upon us what might be in store for us if they are not beaten.

Somewhere in Belgium, the Belgians publish secretly the small paper called "La Libre Belgique,"

which is reproduced as part of this story. It is now in its third year, and the Germans never have been able to suppress it. Every week or ten days there is a new issue, one of the first copies of which is sent through the German Post to the German Governor General. This little paper, which is free, circulates secretly all over Belgium, in spite of the fact that to be found with one in your pocket or in your home is sufficient reason for the Germans to send you to prison or to Germany. The satisfaction which the Belgians derive from their ability to do this, and other similar things, without submitting to the German will, helps greatly in keeping up their courage and morale.

321 4
JUILLET 1918

NUMERO 88 DEUXIÈME ANNÉE
PRIX DU NUMERO — Élastique, de zéro à l'infini (prière aux revendeurs de ne pas dépasser cette limite)

LA LIBRE BELGIQUE

FONDÉE
LE 1^{er} FÉVRIER 1915

J'ai toi dans mes destinées, un Pays qui se défend s'impose au respect de tous ce pays ne peut pas! Dieu sera avec nous dans cette cause juste. ALBERT, Roi des Belges (1 août 1914)
Acceptez provisoirement les sacrifices qui nous sont imposés et attendez patiemment l'heure de la réparation. A. M.A.S.
Mons MERCIER

Envers les personnes qui dominent par la force militaire notre pays, ayons les regards que commande l'intérêt général! Souvenons les régressions qu'elles nous imposent aussi longtemps qu'elles ne portent atteinte ni à la liberté de nos consciences chrétiennes ni à notre Dignité Patriotique.

BULLETIN DE PROPAGANDE PATRIOTIQUE — RÉGULIÈREMENT IRRÉGULIER
NE SE SOUMETTANT A AUCUNE CENSURE

ADRESSE TÉLÉGRAPHIQUE KOMMANDANTUR - BRUXELLES	BUREAUX ET ADMINISTRATION ne pouvant être un emplacement de tout repos, ils sont installés dans une cave automobile	ANNONCES : Les affaires étant nulles sous la domination allemande, nous avons supprimé la page d'annonces et con- seillons à nos clients de réserver leur argent pour des temps meilleurs.
---	--	--



VERS LA GLOIRE (d'après J.-F. PORTAELS)

A Copy of the Paper Which the Belgians Publish Secretly Despite All Efforts of the Germans to Suppress it

The dominating characteristics of the relations between the Germans and the Belgians are hostility and suspicion. The Germans know that they can make friends only with the traitors, who are seeking their own advantage, and their course of action is determined by the knowledge of that fact. The hatred and contempt of the Belgians is so intense that it is impossible to understand, unless one had observed how they have suffered under the German domination and oppression. Some, whose morale has weakened and who were surrounded by starving families and temptation, have voluntarily accepted the wage of the Germans. In general, however, they hold themselves aloof and suffer in silence, because there is nothing

that they can do to alter matters at present. But let the German beware who goes to Belgium after the war!

The courage of the Belgians merits the highest possible praise and admiration. It appears to be inexhaustible. In spite of three years of oppression, want, misery, and disappointment, they are willing to suffer longer for complete victory, so that Belgium may be Belgian and not German. Though they lose homes, relatives, friends and all they hold dear; though they have sadness stamped on their faces, they are still able to smile so that the Germans may not see how they suffer. They know it is worth while, and realize it must be so in order to win the war for Honor, Justice and Peace.

In Honor of the "Firm of Clayton & Whipple"

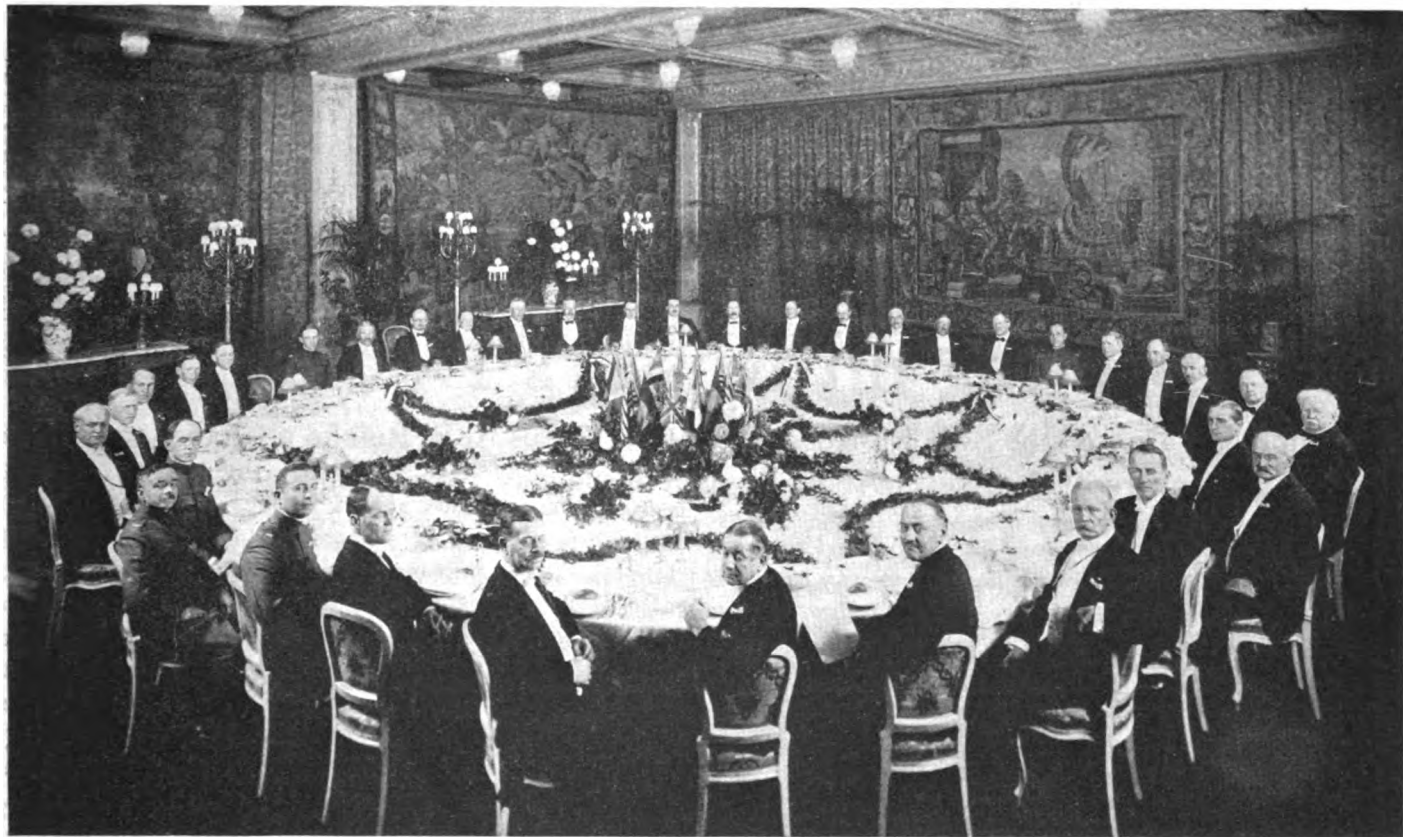

The banquet at Sherry's given in honor of Messrs. Clayton and Whipple by President Thayer. It is not an easy task to identify in a caption such as this a group of men seated about a circular table, but the readers of the News may do so if they will note the vacant chair in the left background, and beginning with the gentleman in the uniform to the right of it, make the circuit of the table. The gentleman in uniform is F. L. Jones and the others in order are, F. H. Wilkins, U. N. Bethell, H. A. Halligan, N. T. Guernsey, P. K. Condict, E. F. Sise, C. H. Minor, E. B. Manley, E. W. Rockafellow, P. L. Thomson, N. C. Kingsbury, A. L. Salt, B. Gherardi, H. D. Arnold, K. W. Waterson, R. H. Gregory, J. A. Stewart, F. H. Leggett, T. N. Vail, C. C. Clayton, H. B. Thayer, A. D. Whipple, J. I. Waterbury, F. L. Gilman, F. Huntington, J. W. Johnston, A. A. Masters, E. B. Craft, J. J. Carty, F. B. Jewett, H. T. Thurber, J. L. McQuarrie, W. E. Leigh, G. E. Folk and D. C. Tanner



F. H. Wilkins Pays Visit to the United States



F. H. Wilkins

see him off. However, that sort of thing isn't done in these warlike days.

F. H. WILKINS, the Company's general manager in Europe, has been spending about six weeks in this country and will start back for London about the time this issue of the News reaches its readers. The censorship prevents the News from stating the exact sailing time or the name of the ship on which he intends to travel, an omission which is to be regretted because it will prevent many of his numerous friends from going down to the pier to

Ever since the war began, more than three years ago, Mr. Wilkins has had a herculean task on his hands. Since August, 1914, he has been handling a flood of new problems, and has been conducting the business of the Company's allied houses in Europe under conditions that were not even dreamed of a few short years ago. One of the difficult matters of which he had charge was the closing of the Antwerp factory, and the disposition of the employees in that city for whom places were found in various other units of the Company's organization. The story by Messrs. Clayton and Whipple gives some indication of the magnitude of the changes made necessary by the German occupation of Antwerp.

While here Mr. Wilkins spent considerable time at the general offices at New York, where he was located for many years, and also made a trip to Hawthorne.

OVERSEAS



Waiting on Russia's Doorstep

An Enforced Delay on the Swedish-Russian Frontier Gives A. E. Reinke a Chance to Tell the Readers of the NEWS About an Out-of-the-way Corner of the World

AS some of the readers of the WESTERN ELECTRIC NEWS know, Mr. Swope has a neat way of handing out a comprehensive job in a few concise words. He recently called me from Tokyo to meet him in Petrograd end of August, if convenient. Now "if convenient" may mean many things: one thing in peace time, another in war, and a third when going to Petrograd.

The recent newspaper reports from Petrograd were hardly of the kind to raise the reputation of that town as a health resort. And the processes of discussing the exact objects of the revolution have not been always salutary to the curious by-stander.

However, my health is as robust as Mr. Swope's, which removed the only excuse for hesitating about the trip.

The direct route from Christiania to Petrograd is normally via Stockholm, including a short and delightful sea voyage. The recent disturbance has removed the prospects of shortness and delightfulness so persistently that travelers now prefer the longer overland trip. The Swedish-Russian Twentieth Century Limited accomplishes the voyage in four days and four nights. The Limited bears straight north for about a thousand miles and makes a sharp curve when threatening to hit the Arctic Circle. Then it plunges south through the thousands of lakes of Finland for Petrograd.

At the sharp curve lie Haparanda, the Swedish frontier station, and Tornea, the Russian, separated by a broad river marking the boundary line.

We reached Haparanda just in time to see the frontier closed for two weeks without warning. Only diplomats were allowed to pass. An engineer not being a diplomat through his instinctive preference for simple

facts, I failed to qualify under the restriction. My only hope lay in the intervention of our Petrograd house. A week later this hope was shattered by a Petrograd telegram expressing regrets. This forced delay has given me ample opportunity to reflect further on the elastic definition of "if convenient."



A Street Scene in Haparanda

Haparanda lies on a level with the center of Alaska. It is clearly a town of many disappointments. Esquimaux and polar bears are about as common here as Indians and buffaloes in the streets of Chicago. Instead of snow houses and mud dug-outs, the inhabitants live in prosaic wood houses, not unlike those of the old Swedish

quarters on the north side of Chicago. Instead of a log cabin hostelry with a combination dining room and kitchen, there is a modern brick hotel. And instead of walrus hide, wax candles and whale oil, the traditional table delicacies of the Far North, we are served highly civilized food of goodly quantity and quality. To complete the list of disappointments, the only cinema in town burned down a month ago, removing the last hope of accumulating a little additional education these two weeks.

Spring has undoubtedly come. It seems to last from about the tenth to the twentieth of July, when early fall frosts may be expected. The birch, dandelion, potato, cabbage and other exotics are making the most of a short season. The mosquitoes have knowledge of Taylor's theory of motion study and lose no time. Flies, the constant companion of man, also follow him to this northerly point.

Tornea, the Russian frontier town, is a forbidden city, due to the Russian habit of locking up in the rail-

way station until train time all the passengers who pass the examination. The traffic between the two towns about a mile apart is maintained in summer by a steamer. In winter the crossing is more exciting. A Finnish driver, for a dollar, piles the passenger and his baggage into a straw-filled box nailed to runners, and then cracks his whip over an animal tied to the box and fondly called by him a horse. In spring time it would be not unreasonable to provide the box with a life-belt.

In the only restaurant in town there gather daily for meal time what probably is the most mixed and promiscuous company on earth today. That they do so without periodic bloodshed and a riot speaks volumes for the pacifying influence of a square meal. The local consuls of the Allied Powers and of the Central Powers come regularly, but naturally prefer to sit at separate tables. The local Swedish town dignitaries and officers have their places reserved and help by their stoic presence to preserve peace. There are traders of every nationality—the Germans who have made Haparanda their headquarters, and the others who go in and out of Russia as often as the good nature of the Russian officials permits. Then there is the stream of humanity of the emigrant type—those relieved to get out and those anxious to get in, including the fire-eating brand of anarchist, that Russia

just now has no need for, but who won't stay away.

Then there is the mass of people of dubious and concealed professions, spies, detectives, watchers of every grade of astuteness. There are Red Cross workers, prisoners of war, newspaper men and even tourists. All languages, and all races may be seen. The air is tense with suppressed nervous tension—and each man wonders who his neighbor is—and suspects him.

(A week later.)

Tomorrow is the sixteenth and the frontier will again be opened. For how long and whether at all is all the subject of uncontrollable rumor. There must be about four hundred people trying to get in. In a town of sixteen hundred population that's a heavy strain on the feeding and housing facilities. How that mob of people will be transported from Torneo to Petrograd is a mystery to any one knowing Russian railroad conditions. There is an easy answer—to turn most of them back. If I manage to get in, I hope to tell you all some time the continuation of this experience, which is more interesting than agreeable.

Note to Censor: I am a born U. S. American citizen—employed with the Western Electric Company since 1896.—A. E. REINKE.

Another Western Electric Man Who is Helping the Government—P. K. Condict

THERE are Western Electric men in almost every branch of the nation's service, all engaged in helping to win the war, but as far as the NEWS can discover there is only one who has progressed so far that he is occupying enemy territory. The man to whom this signal distinction has come is Philip K. Condict, who only a few months ago was holding the position of Foreign Sales Manager for the Company and was varying the monotony of his work by journeying through South America and sending back to the NEWS some of those travelogues for which this magazine is famous, or infamous, depending upon the individual reader's liking, or lack of liking, for that sort of article.

The enemy territory in which Mr. Condict is now encamped is not more than three or four blocks away from the scene of his former activities. It is on lower Broadway in New York City, and until a short time ago was the headquarters of the Hamburg-American Line. The Custodian of Enemy Property took possession of the marble-lined suite of offices maintained by the big German steamship company, and after removing some of the Teutonic decorations and putting up a goodly number of American flags, turned the establishment over to the War Trade Board.

That is how Mr. Condict came into possession of his little patch of German territory right in the heart of

New York. He gave up his work with the Company early last summer in order to help the Government with some of its shipping problems, and at first was attached to the Department of Commerce. Later on, the passage of various war measures by Congress caused a reorganization of the branch of the service in which he was engaged and he finally came under the jurisdiction of the War Trade Board of which Vance C. McCormick is the head. Mr. Condict's particular department is the Bureau of Exports and he is in charge of the Bureau's work in New York. As New York is the nation's busiest port, the importance of Mr. Condict's position is readily understood. His official title is Assistant Director of the Bureau of Exports.



P. K. Condict

His work includes a sort of general supervision of the export trade of the great port of New York. Various licenses have to be obtained from the Bureau of Exports before any ship is permitted to sail, and a shining example of the Bureau's efficiency is the long line of Dutch freighters which have been anchored in the Hudson River as far up as Yonkers for the last month or two. Mr. Condict has a big job on his hands and is performing it in a way that reflects great credit upon the Company which has loaned him to the Government for the period of the war.

Getting the Goods to the Government

Hawthorne Rushes Out Four Car Loads of Telephone Equipment on an Urgent Order and Ships it by Express



F. J. Holdsworth, Warehouse Manager (at left) Talking Over the Details of Packing and Shipping With G. A. Wilson, Who "Chased" the Job. The Pile of Envelopes On the Right Contains the Papers Pertaining to the Job

THE sight of an express car in an ordinary passenger train excites little, if any, interest. An express car standing on a siding is even less exciting or interesting. Yet when four express cars were lined up in a row on the siding in front of the General Merchandise Building on October 23, a large proportion of Hawthorne's 20,000 employees craned their necks to give them the once over and indulged in a mild wonderment over their presence on the M. J.'s right of way.

A string of freight cars a block long would not have earned a passing glance. Everyone who sees the enormous amount of telephone apparatus turned out at Hawthorne realizes that a good many cars must be busy all the time hauling away the product. Otherwise there would soon be no place to put things, even though the big general merchandise warehouse has a floor area of five acres. For the General Merchandise Building is not intended for a storehouse. It is merely a merchandise reservoir. Just as much goes out of it as comes in, although, of course, that does not hold true over a short interval of time. The accumulated stock takes care of the fluctuations. The mighty flow of Hawthorne's stream of merchandise may be gauged from the size of the reservoir needed. Under present rush conditions the warehouse carries about one million boxes containing sixty million pounds of merchandise valued at about \$4,000,000. A force of 175 men is continuously employed in packing, warehousing and shipping the apparatus.

Consequently, a string of cars being loaded with Hawthorne products does not ordinarily start even a slight ripple of interest—provided the cars are freight cars. But a four carload shipment by express! The only explanation of such a procedure that occurred to many was that the shipping department must have given way to an attack of temporary insanity produced by strenuous efforts to rush out orders.

However, there was nothing the least bit crazy about the procedure. This particular shipment was for the Government, and when Uncle Sam needs tools for the big job he has on hand he is not going to stand around waiting for them if we can help it.

It is inspiring to see our whole great big organization buckle down in the traces and all heave together when Uncle Sam needs their extra efforts. Ordinarily, the going does not tax the full strength of the team, but war-time conditions are not ordinary. All day and late into the night our engineers design and experiment to get Government apparatus in the shops in less than the "shortest possible" time. Former "impossibilities" no longer exist. Every engineer, every manufacturing expert, every draftsman, every workman in the shops and the warehouse sets out to break all speed records when a job is needed in a hurry to back up our fighters.

Our experience in handling flood, fire and other emergency orders on telephone equipment stood us in good stead in hustling out the big Government shipment, and by Saturday night, October 20, every detail had been rounded up and the material was ready to go. Monday afternoon, October 22, a telephone message from New York instructed Hawthorne to ship the order by express the following day.

The next move was up to the western traffic department. At 5 o'clock Monday afternoon Chief Clerk Tim Ryan got the express company on the wire and notified them that we wanted four express cars on our siding the next morning. At 9:30 that evening the express company called Mr. Ryan at his residence to tell him that the cars had been secured and that a special switch would be made to set them on our siding early the following



J. H. Hellweg, General Merchandise Manager

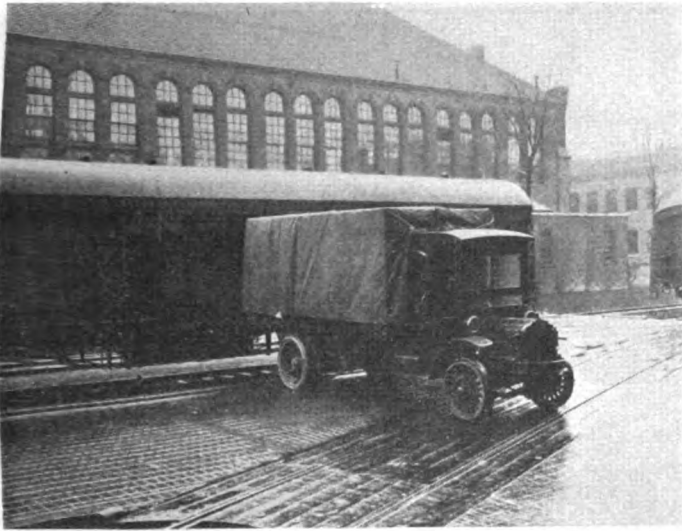

Loading One of the Express Cars. (Note the Traces of Hawthorne's First Snowstorm of the Season on October 23)

morning. They were actually turned over to us at 7 o'clock Tuesday morning.

Considerable thought and labor were necessary to get these four cars properly loaded. The total shipment weighed in the neighborhood of 150,000 pounds—75 tons. It was divided into four lots, each one an exact duplicate of the others. One lot was packed in each car. This method of loading made it easy for the railroad



Trucking On the Shipping Platform

company and the Government men to do a good job in unloading at the other end.

The 150,000 pounds of freight were nicely tucked away on the cars by 6 o'clock in the evening. At 6:30 an engine, which had been held under orders for several hours, made the connection and put through a special switch. The cars were taken first to the downtown terminal. During the day the express company had gathered together material on Government orders from various other manufacturers in sufficient quantities to make four more carloads. A special train, consisting of eight solid cars of express material for the Government, was made up and dispatched at 1:30 o'clock the next morning. The material arrived at its destination thirty hours later.



Packing

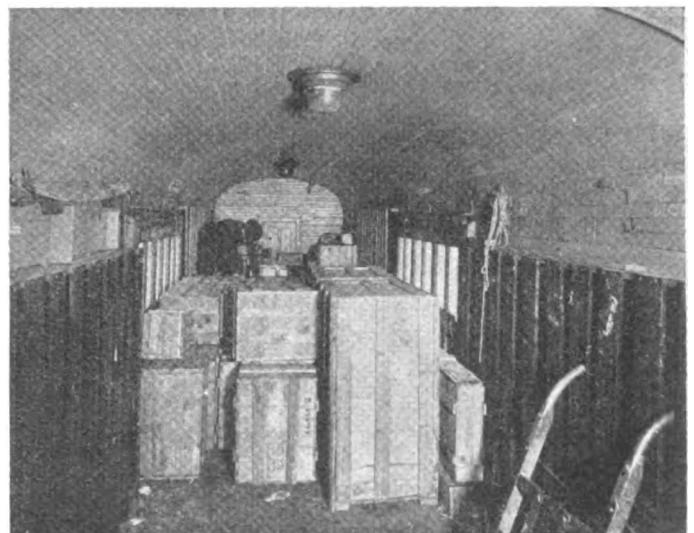

Part of the Shipment in Its De Luxe Quarters

Over Here

[Boston accepts the challenge to combat, which appeared in the November issue, and answers the question "Where?" by the poem which follows.]

Oh why, Brother Wolff, hast thou called back to mem'ry
Those days when the News carried ever a quip—
Aimed straight as a die at the Hub's dainty shoulder,
Upon which there NEVER reposed a chip.

Forbearance and Silence were always the weapons
With which we combated each ruthless attack:
In contrast to tactics employed by Chicago,
Who never neglected a chance to come back.

Yea, gone are the days when the News fairly sizzled—
With shaft anent pulchritude, Red Sox or Braves.—
N'Yawk's wild defiance of "Vive le Giants"
And "Ee yaw" from the Tigers, for those now in
graves.

Atlanta, Atlanta, how time has sped onward
Since days when thy bachelors numbered eleven—
Ah, cruel undoing of possible wooing—
When Editors faltered and left all to Heaven.

'Tis sad to reflect on the misdeeds of Goodrich—
The scribe from Chicago, abetted by Young—
Oh, would that the Hub could pronounce its just
verdict—
"For Courtesies Rendered, Thou Both Shalt be Hung."

'Tis fruitless recalling the shafts we have parried
By message borne forth on the wings of the Dove—
No longer we suffer, our doctrine has carried—
We're shining exponents of brotherly love.

The season of Christmas has opened its portals,
Revealing the beauty of Peace and of Light—
While under the spell we'll be good as immortals—
But soon as it's waning, we're ready for fight.
E. M. T., Boston.

The General Department Girls Who Helped to Make
New York State Safe for Suffrage



They marched in the "Votes for Women" parade in New York City on October 27. Their names reading from left to right are: Misses H. F. Hoey, B. J. Sauer, A. M. Hoey, L. M. Marshall, L. S. Blau, A. M. Riggs, E. Halley, M. E. Bissell, M. Lindsey, L. M. Wendemuth, M. M. Donovan, A. Zindel, D. V. Blozham, A. Mulhern.



These Girls, Who Work in the Pittsburgh Office, Can't Vote But They Don't Seem to Mind it

The Dance at Dreamland

If Hawthorne Club dances have any fault it is too great popularity. No matter how big the dance hall, it never shows any bare spots. The usual big jolly crowd got together November 9, at Dreamland and felt the usual resentment at Father Time for slipping away so quickly that they had to go home long, long before they were ready to. But everything must end at last—and that printer's dash below tells us that no exceptions will be made in favor of this write-up, either.

Married

October 29th.—Miss Agnes Makute, Department 7381, Hawthorne, to Stanley Tietrusseki, of Chicago.
November 28th.—Miss Josie Borowiak, Department 7381, Hawthorne, to Ignatius Foreman, of Oklahoma.

A Voice from the Desert

It has been noticed that manufacturers' representatives, etc., have been passing us up whenever possible since October 20. Dallas is dry. In fact, some have gone so far as to change the name of the town, as is indicated by the accompanying envelope. S. Z., Dallas.

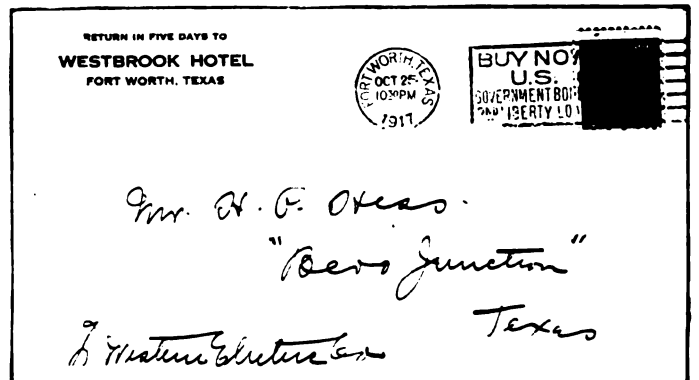

How Low Hath Dallas Fallen!

At the New York Electrical Show



The Western Electric Exhibit at the New York Electrical Show—Mrs. M. S. Tyler of the Advertising Department is Demonstrating the New Virtues of a W. E. Sewing Machine for the Excited Throng

W. E. Quality Products Please Visitors

JUST because the Company's name begins with one of the last few letters of the well known and much respected alphabet it is necessary to turn over a good many pages of the catalog and programme of the 1917 New York Electrical Show in order to find the description of the Western Electric exhibit. No such extended search was required, however, of the visitor to the show which was held in Grand Central Palace last month, for only a blind man could have missed it. A section on the north side of the first floor was given over to a display of Western Electric Quality Products, and, as the photograph shows, the visitors had a habit of crowding around and keeping the demonstrators busy.

Electrical household appliances as useful Christmas gifts and as the answer to the ever-increasing servant problem provided the underlying motif for the Company's exhibit. Within the booth there was a semi-circular platform, divided into two parts by a wall. One side was fitted up as a living room and contained for demonstration such appliances as the portable sewing machine, vacuum cleaner, table portable and floor lamps. The other side represented a kitchen, containing a washing machine, iron, range and dishwasher,—all electrically operated. On the three sides of the booth, below the stage, the remainder of the complete line of Western Electric Household Quality Products were exhibited and demonstrated.

The exhibit was designed not only to interest housewives in the appliances themselves but rather to afford a liberal education in the ways in which electricity will assist in the scientific management of the home.

The Show Through a Demonstrator's Eyes

One need only answer or rather try to answer for a few moments the questions of a passing crowd to have his belief completely destroyed that the average human is possessed of at least a degree of intelligence. You see I was a demonstrator for ten days in the Western Electric Booth at the Grand Central Palace here in New York. Our display represented the interior of a living room and kitchen. The rooms were placed on a fairly high stage with footlights and everything that goes with a regular show, except the orchestra and flowers. So you see how it was that I saw and heard these queer things:

"Is it necessary to have electricity in the house to run an Electric Sewing Machine" or "Does that Foot Warmer (pointing to the rheostat on the floor) come with the machine?"

Here is an opportunity for our struggling, yes, starving, inventors to add another dollar to their bank account—combine an Electric Sewing Machine Foot Switch and a Foot Warmer in one. The demonstrator claims one-half for the suggestion.

The exhibition provided lots of humor as well as a lack of intelligence. A weary mother selecting the demonstrator as a means to check the flow of tears from the eyes of several tired youngsters—"Come here and see something funny" is what she told the children, pointing to the W. E. stage where I stood in the spotlight—the tears immediately turned to laughter and I was it.

If you contemplate a study of human nature ask to be appointed as demonstrator at the Electrical Show next year.

M. S. T.



To be Awarded in December

TWENTY-FIVE YEARS			
Barry, J. H., Hawthorne, 5771.....	December	—	
Canfield, M. E., Hawthorne, 6505.....	"	2	
Hyland, F. J., New York.....	"	21	
Ligibel, O., New York.....	"	—	
Muller, O., Sr., New York.....	"	—	
TWENTY YEARS			
Dykeman, F. W., Chicago.....	December	3	
Richardson, D. C., New York.....	"	6	
Fiille, L., New York.....	"	27	
Whitley, S. L., New York.....	"	7	
FIFTEEN YEARS			
Pehrson, A. A., Hawthorne, 6505.....	December	11	
Larson, C., Hawthorne, 6302.....	"	18	
Schwass, H. F., Hawthorne, 9859.....	"	16	
McAuliff, Hannah, Hawthorne, 6320.....	"	19	
Rentzmann, Emmy, Hawthorne, 5540.....	"	20	
Hagemester, W. J., Hawthorne, 6966.....	"	21	
Decker, M. H., Hawthorne, 5925.....	"	26	
Anderson, A. J., Hawthorne, 6194.....	"	29	
Flood, A. H., New York.....	"	4	
TEN YEARS			
Morton, W. B., Chicago.....	December	3	
Sioussat, W. L., Cincinnati.....	"	23	
Smith, W., Dallas.....	"	2	
Lindgren, A. R., Hawthorne, 6300.....	"	3	
Kommer, P., Hawthorne, 6161.....	"	4	
Fuhrmann, C. E., Hawthorne, 6035.....	"	5	
Bowker, Lillian V., Hawthorne, 5939.....	"	6	
Newton, G. R., Hawthorne, 6337.....	"	14	
Van Houten, D. T., Hawthorne, 6877.....	"	16	
Haberberg, C., Hawthorne, 6300.....	"	23	
Johnston, C., New York.....	"	3	
Riecken, W. E., New York.....	"	11	
Schortman, E. O., New York.....	"	27	
Paul, Marie C., St. Louis.....	"	13	



J. H. Barry

J. H. Barry

"Why do they call you fellows 'millwrights'?" an inquisitive Hawthornite asked one of them one day.

"They don't," was the answer. "They call us almost everything else, though, because we can't be in 16 different places at once and do a week's

job in half a day on 15 seconds' notice. But we call *ourselves* millwrights for two very good reasons: First, because that is our proper trade name, and, second, because we're in wrong so often that we like to hear ourselves called 'wright' part of the time."

But it appears that this outburst as to the unhappy lot of the poor millwright must be an overly pessimistic one, for up bobs J. H. Barry for a new service button this month after 25 years spent at millwright work, and John still manages to get considerable enjoyment out of life.

Mr. Barry was hired at Clinton Street on December 17, 1892, just in time to be put on the job of setting up the Western's big exhibit for the World's Columbian Exposition, otherwise the Chicago "World's Fair." His jobs since have all been done within our own portals, but that does not mean that he has suffered for the lack of something to do. Installing new machinery, putting in ventilating systems, equipping machines with guards, putting up steel partitions, mounting shafts and pulleys, not to mention a few million other little jobs, have kept him from being worried over a possible lay-off, even during slack times.

Mr. Barry, who was transferred to Hawthorne in 1908, is now a sub-foreman in the Works' millwright department.



M. E. Canfield

M. E. Canfield

The next time you happen to run out to Australia or over to Porto Rico or London or almost any old place ask some telephone installer whether he knows Myron Canfield. If he doesn't he is a greenhorn at the game.

Mr. Canfield started working for the Western at New York in 1892, just after graduation from Stevens' Institute, and he has worked for the Company almost everywhere else on this little old globe since then. At present he is the specialist on power work for the installation methods department, and in that capacity he is now down south working on emergency military installations.

In his early days Canfield was a combination vest-pocket edition of Jess Willard and Frank Gotch. He did not weigh much, but neither does a wild cat. As a boxer and wrestler Myron was the king pin of the lightweight class in the old Knickerbocker Athletic Club of New York. Nowadays, however, he is Hooverizing all the surplus energy he does not use on his job, so as to be able to carry the extra star which will be added to his service button this month. He is the proud bearer of two already.



D. C. Richardson

D. C. Richardson

Among the men who add stars to their service badges this month is D. C. Richardson, General Auditor of the Company, who has been a Western Electric man for twenty years. His fiftieth birthday and the twentieth anniversary of his service with the Com-

pany come so close together that it is no trouble at all to discover that he must have begun to work for the Company when he was thirty years of age.

Before that he had attended Dartmouth College for the requisite four years and had been graduated with the degree of Bachelor of Letters, a distinction which he attained in 1891. The next six years he spent in the First National Bank of Concord, N. H., entering the employment of the Western Electric Company in Chicago in December, 1897. For two years he devoted himself to the compiling of reports and statistics, and in June, 1899, became cashier in Chicago, a position which he retained until 1902. From 1902 to 1909 he was Chief Auditor in Chicago and New York, and from January, 1913, to the present time has been general auditor.

In all that score of years, Mr. Richardson has reported to but three men, a rather unusual record. The three are Messrs. C. G. DuBois, J. W. Johnston and R. H. Gregory.

If you want to know just what sort of man Dan Richardson is, listen to this statement. The first thing he reads in his morning newspaper is the sporting page, and he isn't afraid, nor ashamed, to admit it either.

Their Superior Officer

[A letter which preceded the general auditor on his last trip to Richmond. It came from his own department where they ought to know him.]

"I presume Mr. D. C. Richardson has reached Richmond and I trust begun an audit on the Richmond House. It was the intention of the undersigned to prepare you for his visit, having the letter reach you at the time of his arrival. Owing to our having to put in so much time priming him for the work he is to attempt, this could not be done. It was impossible to send you a regular auditor at this time and his visit is more or less in the nature of a war measure.

"One thing should be clearly understood from the start, and that is Mr. Richardson is in Richmond to work! You are not to entice him away by offers of any form of entertainment, including moving picture shows. He promised faithfully, on leaving New York, to complete the audit in twice the time taken by a regular auditor and to work every evening to accomplish it. If you have a spare clock number I would suggest you assign it to him. If not, daily reports to this office would be appreciated. We are confident his audit will be very thorough, providing he is allowed to work.

"The question may arise in your mind, why this department picks on the Richmond House. The main reasons are, your lovable disposition, the good hotels, the beauty of your city and, last but not least, prohibition.

"Any little courtesy you can extend the auditor concerning his work will be appreciated. Perhaps if you show him this letter it will spur him on to better work (it may also result in our getting fired). So please use your own good judgment.

"Very truly yours,
"G. B. PROUD,
"J. B. COLES."

They Get New Stars This Month



Otto Ligibel



S. L. Whitley



W. J. Hagemeister



Charles A. Larson



F. W. Dykeman

Who's Who at Hawthorne



WHO makes the tools that make the parts that make the 'phones that talk (you know the story well, dear hearts)—from Frisco to New Yawk? Who thinks a thousandth of an inch from prints is blacksmith work; says: "No machinist, that's a cinch! That job would shame a Turk"? Who always was a lucky guy—(just sold his old buzz buss, which couldn't make

twelve miles on high—but sure could make a fuss)? Who rushed out tools for Mono-Cords in less than nothing flat? (That's speed, boys. Beat that with your Fords!) Bill Ruthven. Bet your hat.

He Cheats the Photographers

A. A. PEHRSON, who completes his fifteenth year of service this month, either was afraid to trust his features to a camera or vice versa because, instead of sending the News a photograph of himself, he drew the sketch which is reproduced at the right. It always is refreshing to find a man who cares so little for the false lure of beauty as Mr. Pehrson evidently does.

One thing is certain: Mr. Pehrson in his communication, which inclosed his autographic portrait, made no request for its return and thereby saved the editors of the News from considerable worry.

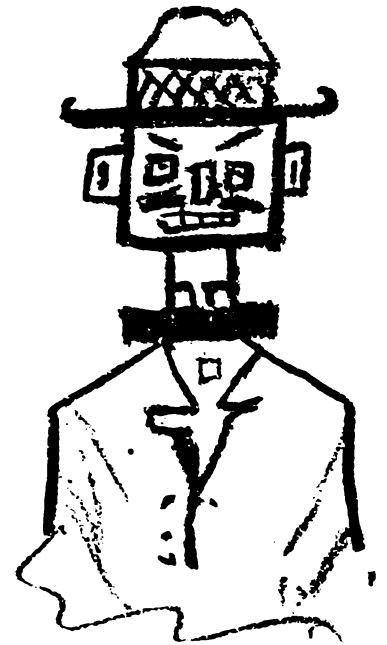

A Christmas Message From Theodore N. Vail

The President of the American Telephone & Telegraph Company Sends Holiday Greetings to the Employees of the Bell System

TWO THOUSAND years ago a new era, a new religion, dawned upon the world. We are approaching the anniversary of that dawning.

Whatever of civilization, of freedom, or of liberty we have and enjoy, comes from the subordination by man of human passion and selfishness because of the teachings, the incarnation or reincarnation of the ideals and principles of that religion.

Peace and good will on earth to men; peace on earth to men of good will is the basis of liberty of mankind.

Our democracy is based on liberty, the liberty of *all* to live and enjoy life, the fullest liberty to each individual consistent with the same right to all other individuals. More is impossible.

Under this civilization has come greater peace throughout the world. Wider intercommunication and more neighborly feeling towards our fellow-men have been developed. Wonderful instrumentalities of transportation and communication have built up that world-wide social and economic organization which brings within the reach of all so much which would be impossible without it.

Man's self-dependence, or independence of others, has passed, but in its place have come greater possibilities of life. Dependence of man upon man implies service of man to man.

To maintain democracy, civilization and service, convention, regulation and law, an organized government is necessary.

The difference between the organization of the government by democracy and that by autocracy is that democracy is government by the will of the governed, and not the government of a few acting by usurped power or that of an insurgent minority.

Government by democracy must be enforced as vig-

orously, impartially, unflinchingly as that by any other government.

They who differ may express their difference, may do all possible to convert others, so long as it is not done in open defiance or in active rebellion, and so long as their actions are subordinated to the will and authority of the majority.

If and when a majority of all cannot be trusted to express the will of a people, cannot be trusted to act wisely, and all are not willing to abide by it, any government except government by force will fail.

Our democracy is now threatened from without and the democracy of the whole world is at stake.

The protection of our democracy must come from those it protects. Every individual, to its protection owes all life, liberty, substance. To the protection of that democracy he must if necessary devote all.

We who have served the Bell System know what service means, but only in a degree, however, is the service we have learned to be likened to the service for which we are now called upon.

Many of us are already serving at the front. All of us are serving in some way and are ready to serve wherever we can and are needed.

To the members of the Bell System the opportunity for the gift of service is particularly great. Each individual, man or woman, in the service of the Government or the Company is responsible in a large degree for the country's safety and welfare, for the success of liberty and democracy the world over, for the future freedom of humanity.

Let us dedicate to our country, in whatever way, whenever and wherever we may be called, our unhesitating, unflinching service, implicit in its obedience and subordination to duty and authority.

THEO. N. VAIL.

Omaha's New Correspondent



A. C. McLean

A. C. McLean has been appointed correspondent of the News for the Omaha house. His autobiography is brief and to the point. Here it is:

"Started with the Western Electric Company September, 1915, taking student course at Hawthorne, June, 1916, transferred to General Telephone Sales

Department, Hawthorne. March, 1917, transferred to Omaha Sales Department. Now in the Sale of Farm Lighting Plants."

Results of New Customers and New Business Contest for August, 1917

THE salesman securing the largest number of new customers during July was:

E. S. Moorer, Atlanta

The salesmen securing the highest number of points or sales to new customers for the period ending June 30th were:

E. H. Waddington, St. Louis, 868 points.

E. S. Moorer, Atlanta, 460 points.

J. H. Pearson, Richmond, 458 points.

TALKING IT OVER

AN OLD EMPLOYEE WRITES TO THE NEWS

IN its last issue the NEWS urged the employees of the Company to make this page their own by contributing to it their views on subjects of timely interest. The first employee to take advantage of that invitation is H. B. Thayer who has been one of the Company's workers for almost 37 years and now holds the responsible position of President.

He has written to the NEWS to express his admiration for the loyal service rendered by C. C. Clayton and A. D. Whipple who have just returned from Antwerp, Belgium, where they have been safeguarding the Company's property and interests through three trying years. Mr. Thayer has the following words to say of the "Firm of Clayton and Whipple," which, as he said at the dinner given in their honor, forcibly took possession of our business in Antwerp and managed it for us. Their experiences under German rule in Belgium constitute the leading article in this issue.

THEY DID A GOOD JOB

EDITOR OF THE NEWS:

Taking advantage of your suggestion in the last issue of the NEWS, I am going to "talk over" with your readers some of the thoughts suggested to me by the return of Messrs. Clayton and Whipple. I am now one of the oldest ten employees of the Company's thirty thousand, and I am going to talk as an old employee who has seen most of the history of the Company and known many of its employees.

Loyalty to the Company—pride in its achievements and good name—pride in being an employee of the Company are what we are all accustomed to feel and see.

That's because it's a good Company with good traditions and high ideals, and has been in business years enough so that it has acquired confidence and respect and something close to love, and also because we employees are pretty good stuff ourselves if we do say it.

So that when a man or woman does his or her part well or more than that, we see it and appreciate it but do not talk a lot about it because it's what we all expected, just as at the front it's the coward who attracts attention more than the man who is bravely doing his duty, but once in a while someone goes away beyond the requirements of duty and performs a service which simply has to receive special recognition.

We have known cases where great personal sacrifice has been involved, and some cases where there has been risk of life as at the time of the San Francisco fire.

In the case of Clayton and Whipple, their fate might have been worse than loss of life.

Of those in responsible positions at Antwerp at the time of the bombardment, duty called some of them elsewhere; with Clayton and Whipple, there was no duty call. They had done all that could be expected of them, and were free. They elected to do their best to safeguard the Company's interests, to look after the homes of our employees who were obliged to leave, and to care for our Belgian employees who remained.

They did it, and they did a good job at it. In doing it, they were called upon for all of their reserves in tact, diplomacy, firmness, and courage, and their reserves answered the call.

That's why we are proud of them, proud to be their fellow employees, and proud to be employees of a Company which can stimulate that kind of a response.

H. B. THAYER.

A SERVICE NUMBER NEXT MONTH

IN its January issue the NEWS hopes to devote a large share of its pages to those employees of the Company who are in military service. On land and sea, at home and abroad, the Company's workers are giving the best that is in them to the great task of winning the stupendous conflict that has engulfed the civilized world. All that the NEWS can say about them is as nothing compared to the sacrifice which they are making so willingly and so cheerfully.

Of course the two radio companies, that from Hawthorne which is in training at Fort Riley, Kansas, and the New York boys who not long ago went to Camp Sherman at Chillicothe, Ohio, will be made the subjects of special articles, but the NEWS also wants to hear from all the Company's soldiers and sailors, no matter where they may be. Each and every one of them will find a warm welcome awaiting him in its columns.

THE SEASON'S GREETINGS

AMERRY CHRISTMAS and a HAPPY NEW YEAR is the greeting which the NEWS extends to its readers. None of the new fangled phrases means as much as the old one which has come down to us through so many years.

Lieutenant E. C. Platt, Jr.

Well-Known Western Electric Man Meets Death Under Fire in France

CABLE dispatches received in this country on November 15 reported the death of E. C. Platt, Jr., who was the Company's European auditor when in March, 1916, he obtained leave of absence to enter upon military service.



Lieut. E. Cuthbert Platt, Jr.

Mr. Platt was born on October 29, 1879, was educated in the Brooklyn Latin School and at Princeton University, from which he was graduated in 1901 with a degree of A.B. He was first employed in the clerical department at New York in June, 1901, and occupied successively thereafter the positions of chief clerk at the Philadelphia and Indianapolis offices, clerical inspector and chief accountant of the Company located at Chicago, assistant comptroller at New York, and subsequent to May, 1912, the position of assistant comptroller and finally auditor of our London office.

Mr. Platt's death was a distinct shock to his many friends in the organization in America. He was the first employee of the Company in America to volunteer for service and, so far as is known, the first to meet his death.

F. H. Wilkins, general manager of the Company's European organization, who is now in the United States, has written the following tribute to his memory:

A Friend's Tribute

"My acquaintance with Mr. Platt dates from 1897 when I met him at the Marine and Field Club in Brooklyn. Mr. Platt's father was a member of the Club and the son was a youth of about 18. It was some years later and after he had been graduated from Princeton and had entered the service of the Western Electric Company that we became better acquainted. In 1912

Mr. Platt was appointed European comptroller of the Company and that was the beginning of a friendship and a close personal relation which has only now been terminated by his death.

"On August 1, 1914, when war broke out, Mr. Platt was of course in Europe, and during the next two months, and until the final occupation of Antwerp by the Germans, Mr. Platt made several trips from London to Antwerp on business of urgent importance to the Company, sometimes carrying large sums in cash and always ready and in fact eager to accept any service, however arduous and difficult or dangerous it might be.

"During 1915, the conviction seemed to be gaining strength in his mind that he ought to be more actively helping the cause of the Allies, and he made several earnest efforts to get into the British military service, but without success. He finally learned that the most promising plan was to go to Canada and there apply for admission into the Canadian Expeditionary Force. Mr. Platt decided to adopt this course and having obtained leave of absence from the Company's service for the duration of the War, sailed from Liverpool on March 6, 1916, for New York, proceeding almost immediately to Montreal where his application for a commission was soon granted. I was his companion on this voyage, as it happened that I was making one of my periodical trips to America.

"In April of 1917, Mr. Platt arrived in England as first lieutenant of the 244th Battalion Canadians, known as 'Kitchener's Own.' This battalion, however, was afterwards broken up, and it was after four months of hard training that, as first lieutenant of the 24th Battalion Canadians, Mr. Platt on August 6 finally went over to France.

"Since then I have received several letters from him, all of which, including the last dated October 8, have been full of the cheerfulness and courage so characteristic of him. He was a man of high character, a delightful companion, loyal to the interests of his Company and true to his friends and to himself. All who knew him will mourn, with a deep feeling of personal loss, his untimely death." (Signed) F. H. WILKINS.

Some of the Things the Red Cross is Doing

A few facts taken from a cable lately sent to Mr. Henry P. Davison, Chairman of the Red Cross War Council, by the Paris Headquarters of the American Red Cross:

"We have established twenty dispensaries in the American Army Zone to care for the resident civilians. . . .

"We are operating six canteens for use of French soldiers—where we serve about 30,000 soldiers a day.

"We are providing an artificial limb factory near Paris.

"Our hospital distributing service sends supplies to

3,423 French military hospitals—our surgical dressings service supplies 2,000 French hospitals and is preparing immense supplies for our own army.

"We have opened a children's refuge and hospital at a point in the War Zone.

"We are making arrangements on a large scale to help refugee families through the winter.

"200 tons of supplies are arriving in Paris daily."

Hawthorne Boy "Captured or Missing" in France

Herschel Godfrey Among the First Men Lost by the U. S Expeditionary Forces

GEN. PERSHING'S report of our first casualties in the trenches contained among the "captured or missing" the name of Herschel Godfrey, Chicago. Young Godfrey was one of a small group of



Herschel Godfrey

American soldiers cut off by German barrage fire and suddenly attacked by an overwhelming force of Boches.

Before enlisting in the regulars, Godfrey had been employed at Hawthorne in the loading coil inspection department for a little over 15 months. He left May 10, just after the Joffre parade in Chicago, which had clinched his determination to enlist. He was sent to France from Camp Baker with the first American expeditionary forces.

He was sent to France from Camp Baker with the first American expeditionary forces.

He was sent to France from Camp Baker with the first American expeditionary forces.

In the loading coil inspection group Godfrey was distinguished by his exceptional size and strength. His fellow workers are confident that he must have made things decidedly interesting for the Germans before being overpowered. He was, they say, "just that kind of a fellow." This opinion seems to be borne out by the press dispatches concerning the bravery of the trapped Americans. The reports stated:

"The French general in command of the division of which the American detachment formed a part, expressed extreme satisfaction at the action of the Americans, for they fought bravely against a numerically superior enemy, the handful of men fighting until they were smothered.

"The whole American expeditionary forces are thrilled by the fight put up by their comrades and all are anxious to get a chance to deal a blow in return."

We hope later reports will show that young Godfrey escaped uninjured and has merely been taken prisoner.

In the meantime his many friends at Hawthorne will read anxiously every scrap of news from the front, and will do what they can to lessen the burden of worry which his family will of necessity bear.

For the Red Cross

Now Is the Time to Join

THE NEWS gladly devotes this space to the interests of the Red Cross, which this month is making what has been termed a Christmas Membership Drive. It wants 10,000,000 new members by the first of the new year, and that it may obtain them, and more too, is the wish of everyone who has the true interests of the nation at heart. The chairman of the committee in charge of this great membership campaign is Theo. N. Vail, whose name and works are familiar to every reader of the NEWS.

No doubt a large proportion of the employees of the Western Electric Company already are members of the Red Cross, but can anyone offer a valid reason why every one of them should not become a member? There are chapters of the Red Cross in every city, town and village of the country, and all that it is necessary to do is to seek out the chapter in the place where you live, pay the almost insignificant membership fee, and then offer to do what you can to help in the actual work that your chapter is performing.

Now is the time that the Red Cross asks you to join. It is an appeal that cannot go unheeded by those who understand their country's needs and realize how much the Red Cross has done, is doing, and will do to relieve the sufferings of those to whom the War brings wounds and illness and pain.

From One Who Knows

"UNCLE SAM provides the necessities for the boys on the seas and in the trenches and back of the firing line, in camp and in hospital. But Uncle Sam's organization is for war—stern and uncompromising, relentless.

"There are some of the gentle things which go to make life on the seas and in the trenches a little more endurable, the field back of the firing line less depressing, the camp and fleet more cheerful and the hospital less terrifying.

"For these ministrations our boys must be dependent upon the kind and thoughtful friendliness of those who want to express their love and sympathy.

"We of the Red Cross try to fill this want. Much has been done. We want to do more, and we want you, every one of you who reads this, to be one more to help.

"Let us make a greater Red Cross Christmas gift to America, to our boys and our allies. He also serves who joins the great Red Cross—for humanity.

(Signed) "THEODORE N. VAIL."

This appeal from Mr. Vail appears in the current issue of the Red Cross Magazine. It is reprinted here because the words of Mr. Vail are always of interest to the workers of the Western Electric Company. At present Mr. Vail is devoting his time and labors to the Christmas Membership Drive of the Red Cross, and there is no one better qualified than he to speak with authority of its needs.



ON THE BIG JOB

With the Colors

Employees Under Oath Since Last Issue of WESTERN ELECTRIC NEWS

General Sales Department

New York

MAXON, J. C., Naval Reserve.

Boston

DALEY, W. F., Aviation Section Signal Corps.
GOAD, J. B., National Guard.
GORMAN, J., Reserve Signal Corps.
HAYES, P., Aviation Section, Signal Corps.

Philadelphia

BUDD, H. H., Naval Coast Defense.
McKENNA, R. S., U. S. Navy.

St. Louis

DOWELL, A. S., National Guard.
RYAN, H. P., U. S. Marine Corps.

Engineering Department

New York

LAWRENCE, R. B., Aviation Section Signal Corps.
MILLS, H. C., Aviation Section Signal Corps.
MOWER, C. A., Naval Coast Defense.
MOWER, H. W., Naval Reserve.
ROLLHAUS, P. E., Naval Reserve.
SMALL, G. B., U. S. Marine Corps.

General Manufacturing Department

Hawthorne

COMBS, R. L., Reserve Signal Corps (Radio).
EWART, J. B., U. S. Navy.
HERION, C. A., Reserve Signal Corps (Radio).
HOMER, L. A., Naval Coast Defense.
KUMMEROW, G. H., Reserve Signal Corps.
SEELEY, L. D., U. S. Navy.

General Accounting Department

New York

MAYO, A., Jr., Reserve Signal Corps.

News from Our Boys in the Service

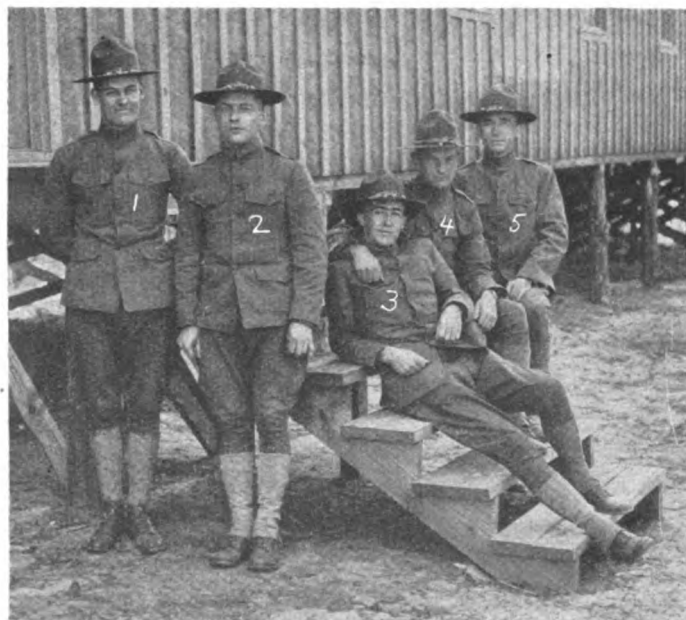

Western Electric Men of the 402nd Telegraph Battalion, Signal Corps, at Camp Jackson, S. C. They Are From the Atlanta House, and Their Names Are: 1, H. Hix; 2, W. W. Lowry; 3, J. C. Stepp; 4, C. V. Weaver; 5, O. Whitmire

In a letter to the new correspondent of the Atlanta house Otto Whitmire, who is now at Camp Jackson, S. C., reports that the members of the Western Electric contingent at that camp are enjoying themselves. He says in part:

"We are all enjoying the Army life. Our organization is made up of a bunch of fine fellows, and we all know

each other, also, know the officers well, and it is like one big family.

"We get lots of exercise and plenty of good substantial grub. We had for dinner today vegetable soup, lightbread, hot beans, sweet potatoes, roast beef, brown gravy, English peas, raisin pudding.

"With best regards to all.

"WHIT."

R. J. Ambler, formerly in the Catalog Division of the Advertising Department, 195 Broadway, and now in



R. J. Ambler is the Man in this Plattsburgh Group Who is Indicated by a Cross

training at the Officers' Reserve Camp at Plattsburg, writes as follows:

"The entire scoring system on the rifle range depends on the telephone, and of course the Camp uses only Western Electric telephones. In rifle practice today, when I turned to throw my empty shells in a box, I found it was an old friend, a W. E. subscriber set case. The name 'Western Electric' is certainly to be seen everywhere around here. The other day when I was on the range, a man went by carrying a Western Electric salesman's catalog. I suppose it was a salesman. I could not break ranks to speak to him, or I certainly would have slapped him on the back. I could have told him that I know the history of every page of the more than 2000 in that book."

And Hawthorne employees with the colors are also giving their dollars. Alex Bernacki, 132nd U. S. Infantry, Camp Logan, Houston, Tex., formerly of department 5913, writes:

"I am getting the WESTERN ELECTRIC NEWS every month and am very glad to get it. I thought the story by Captain Trives very good. * * *

"I bought a liberty bond from the regiment. We are to pay \$5 each month for 10 months, to be deducted from our pay."

Omaha sends in the names of six men who have entered the military service. They are: H. D. Washburn, Chief Inspector, Shop, Signal Corps; V. P. Coupal, Shop, Signal Corps; R. C. Ryan, Stock Maintenance, Ambulance; F. Drake, Warehouse, Engineers; C. S. Powell, Farm Light Specialist, Balloon School.

Sergeant Frank Coston who used to be in Department 6339 at Hawthorne writes to the News from Camp Logan, Texas, where he is stationed with the 131st U. S. Infantry, formerly the First Regiment of the Illinois National Guard. The picture which he sends looks as though he had no fault to find with military life, and his letter says that he likes the Texas atmosphere.



Sergeant Frank Coston



H. D. Quarles, of the Richmond House. He is a Cadet in Squadron A at the U. S. Aviation Field, Fairfield, Ohio

James Malone, who was formerly employed at the West Street house in New York, is now a member of Base Hospital No. 2 of the U. S. Medical Corps, and is serving in France. In a letter to his friends at West Street he tells of many interesting things. Parts of his letter follow:

"I am still in the game as a wireman out here. I have charge of all the electrical work at all the hospitals in our section, working in co-operation with the Royal Engineers (British). The electrical work here is far different from that which we use in the States. Our power plants are all on wheels and most of the buildings are supplied from storage batteries buried in concrete dug-outs six to eight feet below the surface of the earth to protect them from air raids, which seem to be quite frequent of late. I cannot give you any detail of these raids on account of the strict censorship that is held over us.

"The hospitals have been very busy since the big drive started. We are called out at night quite often to help unload ambulance trains. All hands have to turn out when they arrive. It is very exciting at times to be called at 2 A. M. and run a couple of miles through the fields to clear the tracks so that the train can pull in safely."

Howard W. Harris, who formerly worked in the Historical Museum, is now in France, and writes from close to the battle lines:

"We are now the 11th U. S. Army Engineers, Company F, Railway Unit, expeditionary force in France. Possibly you read in the papers about the review our troops had at Borden Camp, England, by King George. We are doing what we set out to do when we left the United States; that is, railway work. We are stationed very close to the German lines, about two miles at the greatest point, and every day Fritz plants a few high explosive shells among the boys. These are 9.2 or about 10-inch shells, and they certainly make quite a good-sized hole when they explode.

"We are provided with metal helmets for protection against shrapnel and also supplied with gas masks. As yet, these masks have not been needed, although we are obliged to wear them fastened to our chest in position for

immediate use, or lying nearby within easy reach. I have seen lots of aeroplane fights, and the big guns are constantly roaring about us. We see and hear both guns and rockets at night, and when we go to bed the firing is 'most as loud as when we are working. Our regiment has been split up, and Charles Barnes' company is now located at another sector of the line.

"One thing that has impressed me here very favorably is the work of the Y. M. C. A. There is a tent in every little village and hamlet where they have all kinds of canned goods, crackers, candies, tea and coffee. They also have the English editions of the daily papers and piano music which they try to keep up to date."

Dr. Roderick V. Grace, whose letters were printed in the News last month, tells more of his experiences at the front in Flanders. There is a note of hope and confidence running all through the letter that is extremely interesting. Portions of the letter follow:

"Since coming up to this sector, which has been the scene of six (6) great offensives since Sept. 20th, life has not been dull for a moment. All the things alluded to and superficially dilated on and talked about in our papers since August, 1914, are here in reality. It is rather a strange sensation at times for one to think that he is present at the time and place of the greatest campaign in history and yet see nothing unusual in it all. It is very easy for one to get accustomed to the things he sees in a place like this. The camps, the towns, battalions going up or coming out of the lines get no more than a mildly interested glance, so accustomed do we get to all of it.

"The air is, when the weather permits, studded with planes or observation balloons—our own, of course. Artillery is coming and going. We live, as a matter of fact, in the midst of a wonderful organization called the Army and forget frequently that it is not the usual condition of life. One sees up here men from the corners of the earth. I wish I could bring you to a famous town here and show you what there is to see. Australian, New Zealander, Celestial (Labor Corps), Polish, French, Belgian, Scotch, Welsh, Irish, English and American.

"Flanders is just now an ocean of mud. Hereabouts the mud is very liquid and varies from

ankle to mid-thigh in depth. The weather is very cold and rainy, as I have said before. Withal our men are very happy and go stumbling by as if at times they were bent on pleasure. *Their morale is wonderful.*

"Since these last pushes the Boche has been giving ground slowly and surely and at a terrible cost. Nothing can stand up to our artillery. When the time for going over the top comes, the barrage is unbelievable. The Oct. 4th stunt cost the Germans, we know tremendously. About five divisions—assembling to attack—were caught in our barrage. The infantry followed close behind and finished up the day's work. The Germans were for once caught so terribly that they hardly could counter-attack although it was of importance to get the ground back at any cost.

"I may explain this all by saying that we have now gotten nearly all the high ground in this part of Flanders. A little more and we expect great results. Everyone here thinks the Boche will pull off one of those famous victory retreats to a new Hindenburg line. You see what a lot of optimists we are—well, we have reason to be. Everything gained now, up here, puts the Hun line deeper in the mire of the Flanders plain. For the first time since the war started he is going to spend his winter being watched and harassed from higher ground. It certainly is a miserable outlook for him. Next Spring, to boot, he is to feel the lash of the most powerful country in the world. Who can blame us for being optimists and the Hun for being otherwise.

"It is a wonderful thing when the Hun planes come over to hear the Archies and machine guns banging away. We content ourselves by lying low and putting our tin hats on and letting it go at that."



G. B. Webster,
Formerly a Claim Man at the
Dallas House, Now a Corporal
in the First Texas Field
Artillery at Camp Bowie,
Fort Worth, Texas



D. Broadhurst,
Formerly the News Correspondent
at the New York House, Now a
Soldier in the National Army
at Camp Dix, Wrightstown, N. J.



W. H. Mikkelson,
Of the General Purchasing Department
in New York, Who is Now in
the U. S. Navy, and is Chief
Storekeeper at Norfolk, Va.

The Installers and the Cantonments

How Western Electric Workers Helped to Prepare the Way for the National Army

THE average physician is fond of discoursing about those various portions of the human body which are forgotten entirely by their owners until something goes wrong with them, but which then become painfully prominent. They are vital to the maintenance of the health of their possessors, but if it were not for the space devoted to them in the medical journals they never would receive any public recognition at all, much as their faithful service deserves it.

The News is going to play the part of a medical journal this month, by calling its readers' attention to the splendid, and in many cases wonderful, work done by Western Electric installation men at the cantonments which have sprung into being all over the country in the last few months.

If the installation crews had done their work poorly everyone would have known all about them, but because they have done it efficiently and well they have kept out of the spotlight up to now. The work which they have accomplished with so much skill forms an integral part of the machinery which the country has constructed to manufacture its great National Army, and the installers on the cantonment jobs, even though they wear no uniform, are soldiers in the great war into which America has entered.

And they have worked and lived like soldiers, too. In some of the cantonments they have had to adjust themselves to military ways; they have slept in barracks and tents; and have subsisted on army rations. Some of them have become so imbued with the military atmosphere that they have forsaken the Company's service to join the colors.

In most of the cantonment jobs the work has been done under great pressure. Speed has been demanded, and things have been accomplished that a few months ago would have been pronounced impossible by the most optimistic head of an installation crew. Performing the impossible has become almost a common thing and there

probably is not an installation gang in the country that has been doing government work that has not eclipsed by an almost unbelievable margin every speed record which it made in the piping times of peace. All through the country it has been a case of getting the job done, no matter how long the hours or how hard the work, and no one has been heard to complain.

The photographs which accompany this article show phases of the installation work in various army camps, and in addition some of the men who have been out on the jobs have written about their work. The limitations of space prevent the News from printing all that they have written, but enough is given to afford the employees of the Company an opportunity to gain an insight into the valuable service that the Western Electric installers have been giving to their country in its time of need. It forms a record of which every one of the Company's workers in all branches of its business has reason to feel proud.

Camp Grant

One of the largest of Army cantonments is Camp Grant, located three and a half miles southeast of the city of Rockford, Ill., a short distance from Chicago.

On July 20 the Central Union Telephone Company requested the installation of a telephone plant. On July 30 six sections of No. 1-D switchboard and sufficient equipment to permit starting the installation were shipped. On July 25 an army of workmen were erecting buildings and installing water and sewer systems on an enormous scale. We did not find the telephone building, as it had not yet been erected, but upon inquiry we were informed that it would be started the following Friday, July 27, and would be ready for us to start work on Tuesday morning, July 31. We moved the switchboards and equipment in on Tuesday morning, as promised.

The distance between the camp and the city of Rock-



The Cable in the Upper Part of the Picture Doesn't Add to the Artistic Effect, But it Does Prove That the Western Electric Installers Had Been on the Job Before This Flag-Raising Took Place at Camp Grant



The Noon Wash at Camp Grant

ford, and the poor facilities for traveling, together with the unlimited overtime authorized, made it necessary that our installers be quartered at the camp. Upon inquiries at the Quartermaster's Department we were informed that each man would be furnished with a new iron cot having good springs, a new mattress, pillow, and blanket. They would also furnish a ten-quart pail, wash basin, drinking cup, soap and towels for a small sum. Our men could eat at the regular mess house which was providing meals for over 5,000 workmen. These meals were furnished at a cost of 30c each, Sundays included. Mess was served in large quantities (old family style), in large dishes placed on the tables. First come, first served, so it goes without saying that our boys got their share three times a day. The food was good, substantial, and well cooked, and intended to satisfy the appetite of hearty outdoor workers without frills.

The switchboard was cut into service on August 24, twenty-two days after the installation was started. This fast service was greatly appreciated by Government officials who were considerably handicapped with a 100-line P. B. X. switchboard which had been giving temporary service. The initial equipment furnished service to 350 lines within the camp, with 40 trunk lines to the nearest exchange at Rockford.

Camp Gordon

On a Saturday noon there was no building whatever on the site assigned to the telephone exchange, and on the following Saturday the exchange was ready for the



The Men Who Did the Work

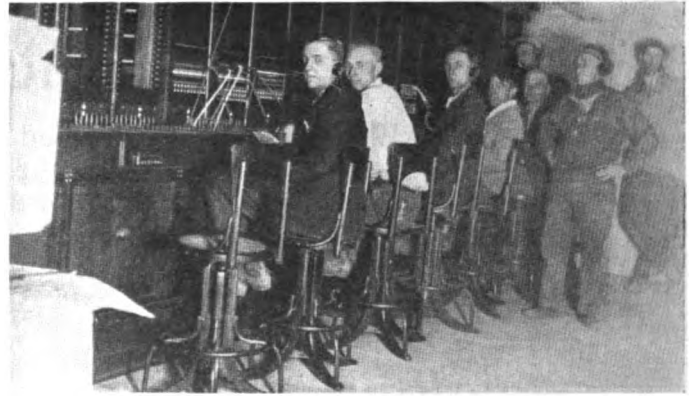

Ready for Service

operators. This was no toy exchange either, but complete in all details. It consisted of seven sections of local and one section of inward toll board; two batteries; gasoline engine emergency charging set, in addition to the regular standard charging set; six hundred multiple and answering jacks; 40 toll switching, and 40 local switching trunks. This was not so bad, but unfortunately none of the installers had seen even so much as a picture of, as Church called it, a one D—board.

At the end of the third hour after the work started the sections were lined up and the iron work completed. At the end of the fourteenth hour the cabling was in the board and connecting at frame started. In the meantime the power work was far enough advanced so that the initial charge was under way.

Camp Lewis

The installation department of the western district completed the installation of six sections of No. 1-D central office switchboard at Camp Lewis, American Lake, Wash. Camp Lewis is the Army Cantonment for two divisions, comprising the men of the National Army from the Pacific States. The switchboard was shipped from Hawthorne on July 21, the building was completed August 1, and the installation started on that date. The completed job was turned over to the customer on August 28 for their test and was placed in service on September 4.



Cantonment at American Lake, Wash., Under Construction



A little team work

Camp Meade

The accompanying pictures show the life at the United States Government Cantonment established about one mile from Admiral, Maryland, and officially designated "Camp Meade," while the Western Electric installers were at work.

On August 23 the installation of the camp telephone exchange began, and, after a drive of seventeen days, the job was completed on September 8 and put in service on the following day, September 9.

The equipment consisted of 8 subscribers' and 14 toll sections (8 outward and 6 inward), making a total of 22 sections.



The Bunch at Lunch

Camp Upton

Word was received on August 15 that the Camp Upton switchboard at Yaphank, L. I., was to be installed and ready for service on September 1. Work started August 20 and was cut over per schedule. All check inspections were made and cleared, and the order was finally billed on November 3 with a bonus of over 30 per cent.

We handled the proposition on a one shift basis. Everyone was up in the morning at 6:30, breakfast at 7:00, at work at 7:30, then the all day drive until 10:00 P. M., with one hour out for dinner and supper. It was really touching to see Foreman Joe Unger each night go the rounds and fondly tuck in everybody. All joking aside, Joe did see everyone in bed before going himself.

Two weeks was pretty good time for doing the job, but modesty prevents us saying how quick it would have been done if all material had been received the first day. The best record, however, was that of showing the old "Western" spirit of "Get the Job in Right and Quick"—

which spirit of loyalty always animates our men when called on in an emergency. We believe the performance here will be continually duplicated during the press of work for the next year.

Camp Jackson

Camp Jackson was handled with promptness, but the speed factor was not so important as the needs of the Government were not so urgent. The cut-overs were handled quietly and without ceremony, much to the sorrow of the highbrows.

When a Muffler Doesn't Muff

OFFICER (appearing at door of exchange at Camp Jackson, S. C., about 2 A. M.): Hey! what's all this shooting over here? Our sentry says someone—

GAS ENGINE: Bang! Bang!

OFFICER: Well, I'll be D——. I now see what it is. That —— sentry said someone was shooting small arms over here and it's nothing but a gas engine.

INSTALLER: Really sorry, Mr. Soldier, to cause you all this trouble, but you see we are charging our battery and the juice went off and we had to start our gasoline engine. It 'most always backfires when we start it. I'll see that it don't happen again.

OFFICER: That's all right, lad. Come over to the "can" to-morrow and I'll buy you a drink. Good-night, Orderly, my compliments to Lieut. Kelly and tell him to put his regiment back to bed.

GAS ENGINE: Bang! Bang!

INSTALLER: Murphy, you go out and hang the wax pot over that engine exhaust.

Now go ahead, Yankee power-men, and ask us "Corn Crackers" why we don't fix our engine so it won't back-fire.

R. A., Atlanta.



The Installers Who Worked at Camp Dodge, Ia. They Are, from Left to Right—Top Row—Pau, Lin, Page, Riggs, Osborn, Bowman, Palmer, Myers, Johnson, Kohler, Myers and Skala. Bottom Row—Johnson, Von Eller, Luckt, Schreiber and Barren

Police Officers Killackey and Dunn, of the Hawthorne Force, Leave to Serve Uncle Sam

Both Men are Veteran Soldiers—Their Army Records

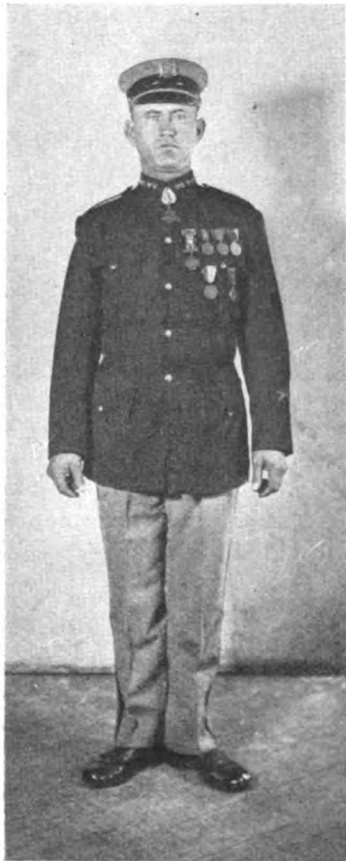

Joseph Killackey,
U. S. Volunteer



A CLOSE UP OF HIS MEDALS

The Five-Pointed Star Medal is One Given "For Distinguished Service in the Presence of the Enemy." The Second From the Left is a New York State Medal "To One Who Served the Nation With Honor"—A Spanish-American War Trophy. The Faces of the Others Show What They Commemorate



Joseph Killackey,
Hawthorne Police Officer

WHEN Uncle Sam asks for Hawthorne's dollars he gets them, and when he asks for Hawthorne's coppers, why, of course, he gets them, too. Lieut. Joseph Killackey and Officer Jeremiah Dunn, of our police department, were summoned the latter part of October to take up work for the War Department. Both men are veteran soldiers.

Killackey enlisted for the Spanish-American War in 1898, but got only as far as Tampa. That was not nearly far enough to satisfy him. Consequently, on his discharge from the Army in 1899, he joined the Navy as a seaman on the U. S. S. Newark. He got farther this time—clear down to the coast of Patagonia—which, however, was no nearer to a fight than Tampa.

At last, though, on his return from the South American cruise Joe got a chance to smell another kind of powder than the sort sailor lads collect on their coat fronts in every port. He was sent to the Philippines, where General Aguinaldo, the insurrecto, was busily endeavoring to collect United States soldiers for a flourishing graveyard he hoped to establish. Killackey and his comrades spent some time on shore, convincing the deluded Filipinos that insurrecting against Uncle Sam classifies as an extra hazardous occupation. Joe re-

ceived a smart rap on the leg in the course of the discussion, but the wound was not serious enough to eliminate him from the dispute. In fact, he and his comrades presented their side so well, and so many of their arguments penetrated, that they were able to return to their ship in about three weeks, leaving their point proved to that particular group of insurrectos, at least.

Early in 1900 their ship left the Philippines for a visit to Japan. Hardly had it arrived there when the Boxer uprising broke out in China and the vessel received orders to proceed at once to Tien Tsin and land troops to join the allied forces. Killackey was among those who landed. He was also one of the 100 Americans who set out with the allied forces for the relief of Peking. There were about 2,000 men, all told, and they had hot work of it against the swarms of Chinese. The Boxers had destroyed sections of the railroad track and bridges, which had to be replaced as the column advanced. At the same time the troops had to fight numerous skirmishes with their swarming opponents.

At last it became plain that they could not reach Peking and they turned back toward Tien Tsin. Then they began really to understand why Chinese labor is so cheap. At a cent apiece John D. Rockefeller couldn't

have bought half the Boxers that had gathered in their rear during the advance. To make matters even more interesting, 4,000 of the best troops in the Chinese army had joined the Boxers. Luckily for the little body of allied troops it was possible for the determined lot of men to force their way through in spite of the overwhelming numbers. But it was costly work charging into barricaded villages and clearing the way for the retreating column.

For bravery in an assault of this sort Killackey received the distinguished conduct medal shown in the illustration. He was one of 20 Americans chosen when volunteers were called upon to take an exceptionally strong position. These 20 men went forward and succeeded in dislodging the enemy. Their loss in killed and wounded was 20—every last man in the detachment was hit. Killackey received a grazing wound along the side of the head just above the temple, but fought on until he fainted from loss of blood. He was picked up by the British ambulance corps, revived, bandaged and put into fighting shape again.

The American naval forces helped hold Tien Tsin after this until the troops arrived from the States. Then Joe and his comrades were returned to the Philippines, where for about a year and a half they engaged in desultory bush fighting with the natives.

Killackey was discharged in 1902, but enlisted again and was assigned to the gun factory at Washington and later to Newport, R. I., to be trained as a ship's gunner. The course included theoretical and practical work in gun construction, shell loading, torpedo making, and firing, etc. After completing his training course in 1904 he was made gunner's mate on the U. S. S. Wilmington and joined her in China.

One of the interesting events of his connection with the Wilmington occurred when the Government authorities invited the Sultan of Sulu aboard the ship to see how the guns worked. In the Sultan's train (besides an exceptionally complete equipment of wives) there was a medicine man of some sort, who was much taken with the ship's incandescent lights. Joe, who was assigned to show him around the ship, allowed him to turn one on and

to his heart's content and finally made him a present of an old bulb. Later, when Killackey visited the Sultan's encampment on shore he found the medicine man much exercised because the bulb, which he had inserted into a bamboo pole, refused to light. If Joe had been a Western Electric farm lighting expert he would probably have secured an order on the spot.

Beyond falling overboard near Borneo and swimming around for what seemed like four or five hours before his plight was discovered, Killackey did not run into anything very exciting on this cruise and at the expiration of his enlistment he left the navy.

In 1911 he again went to work for the Government and spent two years making ammunition in the ordnance department. In 1913 he left to become platoon commander of Company C, Panama Pacific Exposition Guards. While there he was summoned back to New York by the navy and employed adjusting mines for the Atlantic fleet. He came to Hawthorne in 1915.

Jeremiah Dunn, the other Hawthorne officer taking up Government service, left for the quartermaster's department at Jeffersonville, Ind., as an expert harness maker. Mr. Dunn was a saddler sergeant in the British Army in South Africa for four years and took part in the Boer War, where he was wounded in the chest. In 1909 he migrated to Canada and later came to the United States, where he passed a civil service examination that led to his new Government position. He was employed at Hawthorne in December of 1916.



Jeremiah Dunn,
Hawthorne Policeman and Boer
War Veteran, Now in the United
States Service

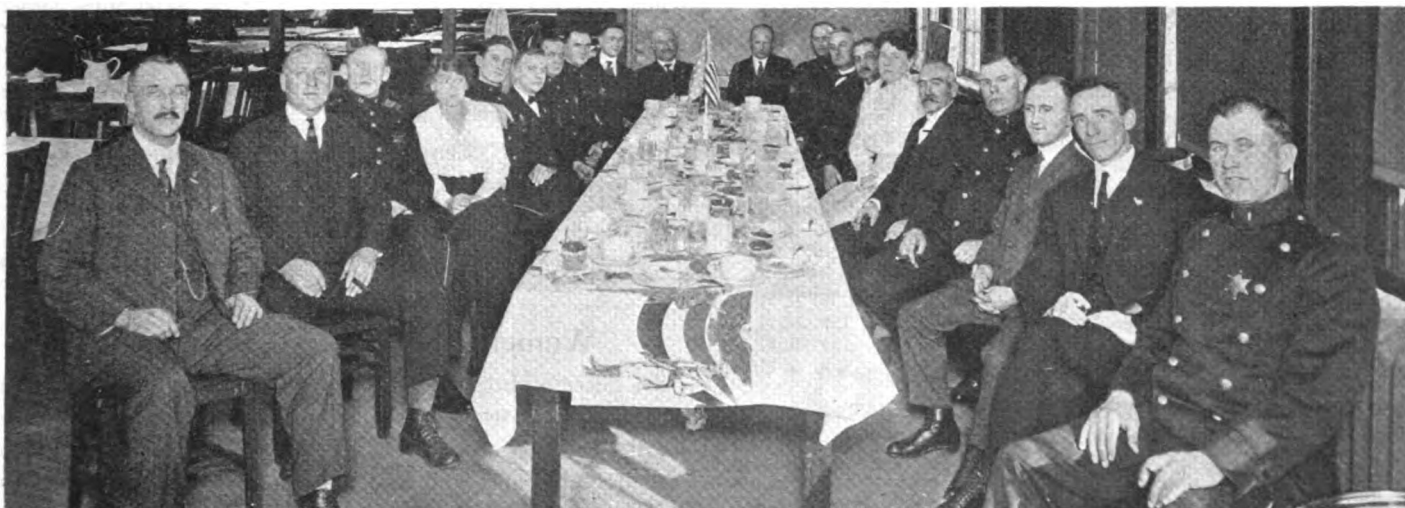

Farewell Banquet Given by the Hawthorne General Service Division to Police Lieut. Joseph Killackey

AFTER THE WHISTLE BLOWS



Tennis Season Ends

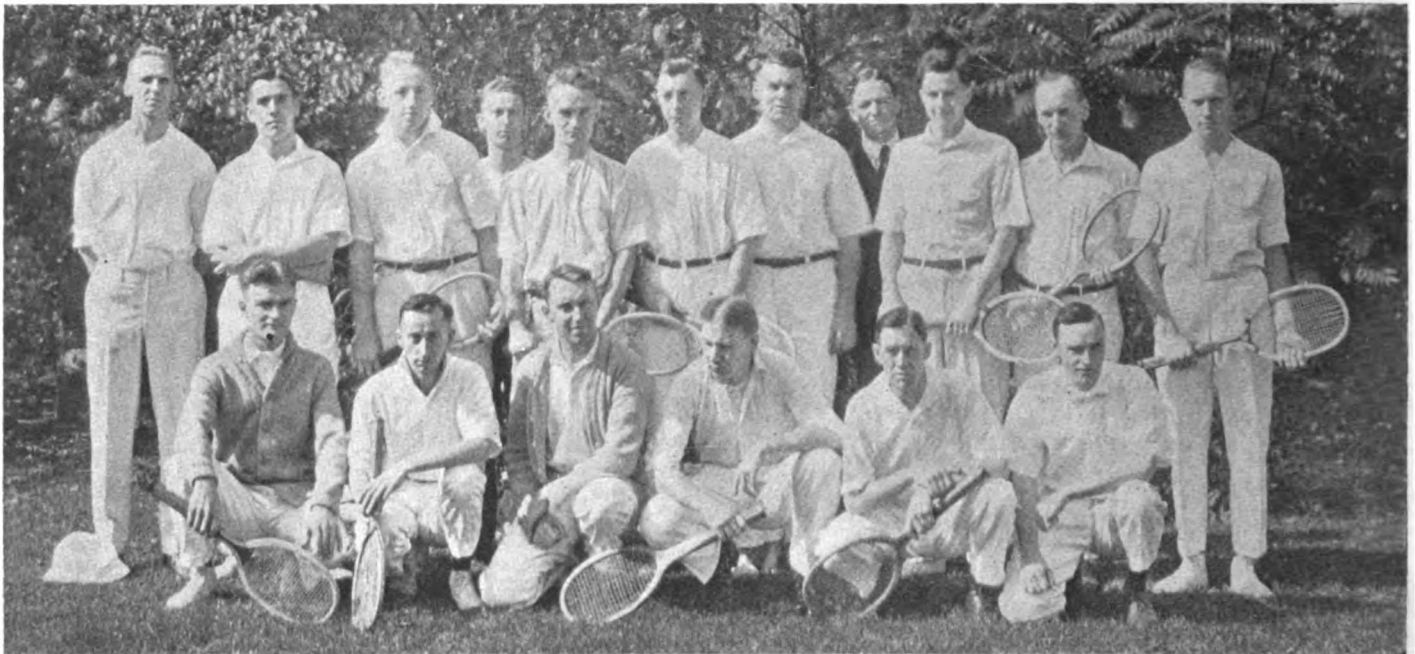

HAWTHORNE TENNIS PLAYERS WHO REPRESENTED THE WESTERN ELECTRIC IN OUTSIDE MATCHES

Top Row, Left to Right—C. D. Hart, L. F. Lamplough, R. H. Dahl, R. E. Orwick, D. P. Craig, E. H. Hess, V. W. Langborgh, D. S. Pratt, A. C. Johnson, J. H. Biggar, C. E. Kelberg. Bottom Row—J. W. Latane, C. A. Cook, G. W. Johnson, R. D. Berry, G. L. Henry, A. C. Jones

LATE in October the feathery flakes of the first snow laid a white blanket on the tennis courts, bringing to an end the 1917 season for Western Electric tennis.

In accordance with the wishes of the U. S. N. L. T. A., the winners of the various tournaments held during the season received prizes in the form of Red Cross memberships. A list of the winners follows:

PATRIOTIC SINGLES TOURNAMENT

Winner—A. C. Johnson.....Gold Medal and \$5.00 R. C. M.
 Runner-up—J. H. Biggar..... 5.00 R. C. M.
 Semi-finalists—J. T. Latane..... 2.00 R. C. M.
 Semi-finalists—E. H. Hess..... 2.00 R. C. M.

CONSOLATION SINGLES

Winner—F. P. Hutchinson..... \$2.00 R. C. M.
 Runner-up—V. A. Halvorsen..... 1.00 R. C. M.
 Semi-finalists—C. A. Cook..... 1.00 R. C. M.
 Semi-finalists—R. Farman..... 1.00 R. C. M.

PATRIOTIC DOUBLES TOURNAMENT

Winners—A. C. Johnson and J. H. Biggar, each a gold medal and \$2.00 R. C. M.
 Runners-up—C. M. Smith and R. D. Williams, each a \$2.00 R. C. M.

CLASS TOURNAMENT

Winner—A. C. Johnson.....Gold Medal

CLASSIFIED ELIMINATION TOURNAMENT

Class No. 1

Winner—J. H. Biggar.....\$2.00 Mds. Order
 Runner-up—J. T. Latane..... 1.00 Mds. Order

Class No. 2

Winner—D. P. Craig.....\$2.00 Mds. Order
 Runner-up—L. F. Lamplough..... 1.00 Mds. Order

Class No. 3

Winner—C. A. Corbett.....\$2.00 Mds. Order
 Runner-up—R. Tarman..... 1.00 Mds. Order

The Women's Tennis Committee announces the winners in the tournament as follows:

CHAMPIONSHIP

Winner.....Miss E. Patterson
 Runner-up.....Miss A. Stahr

Women's Challenge Tournament

In determining the winners in this tournament there were two factors which the committee wished to have count: interest and skill. They, therefore, decided to consider all those who had played four or more matches and to rate them according to the percentage of games won.

It is interesting that Miss Patterson and Miss O. M. Hoppe, who led class A, are also the winners on the percentage basis.

The standing of the first six players was as follows:

	GAMES PLAYED	GAMES WON	PERCENTAGE
1. Miss E. Patterson.....	5	4	.800
2. Miss O. M. Hoppe.....	7	5	.714
3. Miss Reetz	7	5	.714
4. Miss Westlund	5	3	.600
5. Miss Jackson.....	4	2	.500
6. Miss Warne	4	2	.500

Post-Season Banquets

At the annual banquet of the Chicago Tennis Association, held at the City Club on October 10, the Western Electric was well represented. The features of the evening were an interesting talk on "Conditions in Russia" by a member of the Root Commission, and by an outline of the work of the National Lawn Tennis Association in raising a fund of \$100,000 for the equipment and maintenance of the tennis unit in the Red Cross Ambulance Corps. The tennis unit is composed entirely of tennis players affiliated with the National Association, and the Western Electric is represented by L. W. Stratton and

C. H. Hill, who are now in training at Allentown, Pennsylvania.

In addition to the two men who are in the Ambulance Corps the following members of the W. E. Tennis Association are in other branches of the service:

Lieut. S. Crowley, 3rd Regiment, 20th Company, Illinois, Ft. Sheridan, Ill.

A. F. Mueller, Company A, 814th Field Signal Battalion, Junction City, Kas.

Serg. E. J. Darrenogue, Headquarters Company, 338 Field Artillery, Rockford, Ill.

E. Vosyka, Headquarters Company, 338 Field Artillery, Rockford, Ill.

R. L. Coombs, Company A, 814th Field Signal Battalion, Junction City, Kas.

T. B. Larkin, Aviation Department, Signal Corps Section, Washington, D. C.

Lieut. L. K. Weis, Company D, 810th Engineers, Camp Custer, Battle Creek, Mich.

The season ended with a get-together dinner of W. E. tennis men, held at the Brevoort Hotel on November 8. This dinner was the first of its kind and it is to be hoped that it will become firmly established as an annual event. "Eats" that were at once Hooverized and excellent were followed by a series of impromptu speeches. The Red Cross prizes were then awarded, and many songs, patriotic and general, were rendered with marked volume!

GOLF

OCTOBER brought to a close the Hawthorne Golf Club's most successful season with the playing of a 36-hole handicap and the final of the championship. The October handicap was won by F. F. Heppe, with C. G. Holmberg, Jr., and C. A. Monteith in second and third places, respectively.

As noted in last month's NEWS, F. A. Muller won the challenge round for the championship and he, therefore,

met Harry Rautenbusch in a 36-hole match for the title. Mr. Rautenbusch won the match by 7 up and 5 to play.

MORNING ROUND

Rautenbusch, Out.....	5, 5, 4, 4, 4, 6, 3, 4, 4—39
Muller, Out.....	6, 4, 4, 6, 5, 5, 4, 5, 4—43
Rautenbusch, In.....	3, 5, 5, 5, 5, 5, 6, 5, 5—44—83
Muller, In.....	3, 5, 6, 4, 7, 5, 6, 5, 5—46—89

AFTERNOON ROUND

Rautenbusch, Out.....	5, 5, 4, 6, 5, 4, 4, 4, 4—41
Muller, Out.....	5, 6, 6, 5, 4, 4, 4, 4, 4—42
Rautenbusch, In.....	3, 5, 5, 5, 5, 5, 4, 4, 4—39—80
Muller, In.....	3, 6, 7, 6, 6, 4, 4, 5, 6—47—89

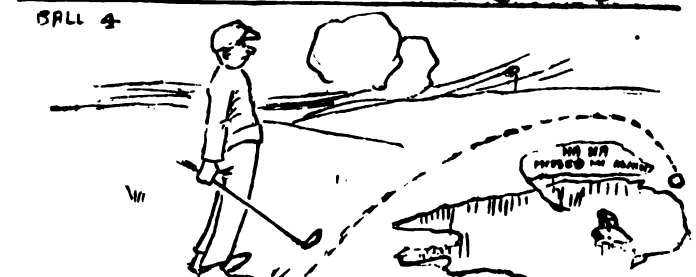
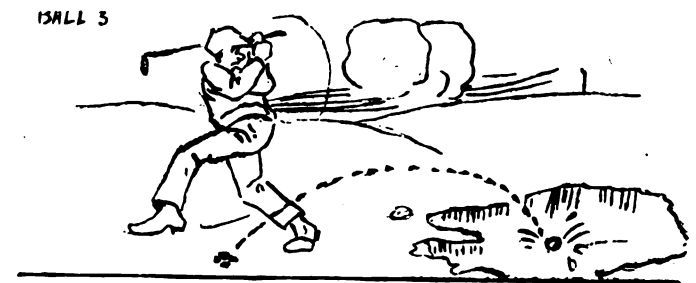
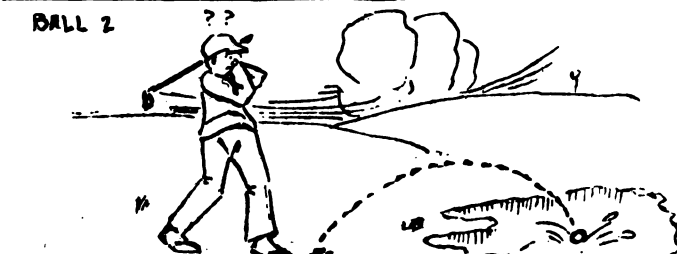
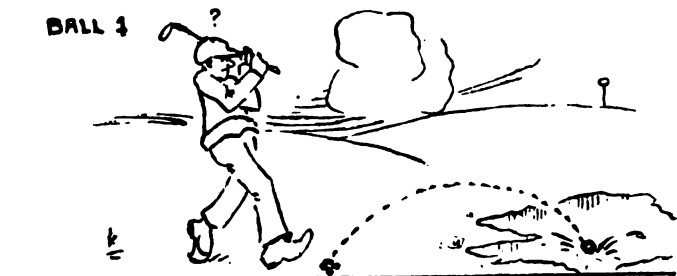

A Hawthorne Golfer Mistreats a Pond. His Name is J. E. McBride. He Works in the Layouts Department, and the Picture Shows How He Played the Seventeenth Hole of the Harlem Course

Here is a Record Holder

The accompanying photograph shows Jake Altweg, the present janitor of the San Francisco House, who, more than any other man, was responsible for the neat, trim appearance of the huge lawns along the Bay Front at the Panama Pacific Exposition two years ago. For months before the first work was done at the Exposition he was busy potting Australian palms and shrubs and preparing them for a shipment to the site, but his real genius was displayed when he was put in charge of the mower shown in the photograph, with which combination of horse, machine and man he set up two working records of mowing 93,955 square feet of lawn in eight hours, and 182,040 square feet in fourteen hours, which records, although not listed in Spalding's Sporting Guide, are worthy of inclusion. He was so good that the Company simply had to have him when the Fair was over.

C. L. H., San Francisco.

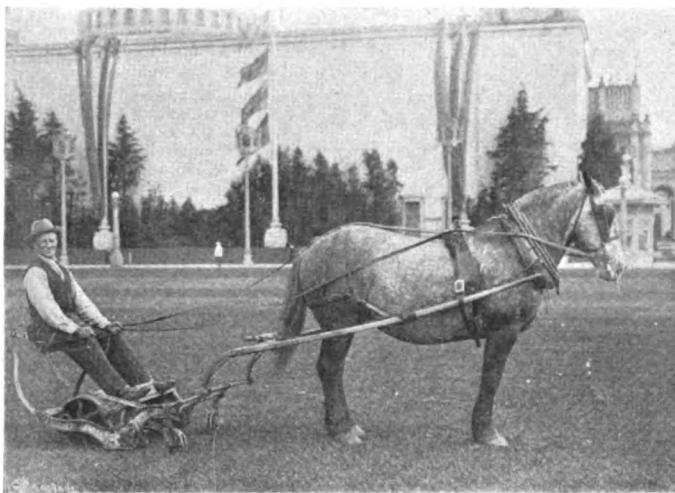

San Francisco's Janitor Who Used to Cut All the Grass in Sight at the Big Fair

Those Fish Bowlers!

You know the talk. "Of course, you fellows do pretty well in the 'fish' leagues, but you couldn't stand the pace in fast company. They'd roll you right off your feet." Now, the Hawthorne Engineering Departments have what they consider a "very classy" little fish league, with 60 bowlers in the weekly league and 40 bowlers in the bi-weekly league, and they don't allow anyone to get away with invidious insinuations. In witness whereof, note the matched rolled the night of November 12 between the fish league stars and the regular Engineering and Switchboard Team, with results as given below. Comments are superfluous.

FISH LEAGUE STARS			SWITCHBOARD AND ENGINEERS		
W. A. Nelson...	168	218	157	E. Dvorak.....	158 155 136
A. H. Krevis...	125	180	180	A. Hornberg....	196 178 188
E. J. Neuberger	148	173	187	F. B. Wilkerson	157 182 166
T. C. Rice.....	188	157	169	E. J. Johnson...	158 134 154
C. D. Dusheck..	179	147	188	R. J. Bender...	191 159 135
	758	870	881		855 808 779
Total Pins—2509			Total Pins—2442		



Richmond's Football Squad. Which Ones Were on the Winning Team? Can Anyone Tell?

Richmond Indulges in Football

Without getting anywhere near a goal line the Stores and Sales Departments had fought for fifty-nine minutes. With one minute left to play, and the ball in the possession of the Stores team on the Sales thirty-yard line, Captain Montgomery called for a forward pass. It was a long one and a pretty one, but the wrong man got there first. T. Stout, substitute full back on the Sales team, leaped into the air on his own ten-yard line, and using his head and his hands in rapid succession batted the ball back ten yards in the open arms of Beckner, his fellow half-back, who, with beautiful interference, eluded the entire Stores team for an eighty-yard run and a touchdown. Failure to kick goal left the final score six to nothing.

The accompanying photograph shows the two teams, in civilians' garb, lined up—not for football—but for the photographer.

G. T. M., Richmond.

Grown in Gilbert's Garden

Great quantities of foodstuffs are being furnished to our Allies across the sea and whom could we better look to for participation in this great service than our Export Manager, Mr. J. J. Gilbert?

H. P. L., New York.



Behold the Potatoes

War Relief Work Started by the Hawthorne Club

One of the objects of the Hawthorne Club is to give pleasure to its members, and since nothing else could possibly give as much pleasure as having the Kaiser and his Huns backed out of Belgium and into oblivion, it is but natural that the Club should organize to help make things easier for those undertaking the good work. With this end in view a "military service welfare committee" has been appointed, whose work it is to find out what will most benefit the men in service and to ferret out ways and means of sending things where they will do the most good and getting them there as directly and with as little wasted energy as possible.

The sub-committee in charge of Red Cross work is already busy, and several groups of Hawthorne girls meet regularly every week to make articles which are turned over to the American Fund for the French Wounded.

A further opportunity to help in the war was furnished by the second Liberty Loan and the Club, through its executive committee, subscribed for five bonds.

First Annual Banquet of the Hawthorne Metal Finishing Department's Executives

"Eat, drink and be merry, for tomorrow you die," remarked a certain man to his soul, and the group in the picture were moved to do just those three things by just that same reason—seeing their finish. A bright and celestial finish it is, too, for these gentlemen are the general foreman, the foremen and the sub-foremen of the metal finishing departments, whose finish must satisfy the hypercritical tastes of our inspection department. The photograph shows them lined up for dinner.

Major Guthrie, of the Canadian Expeditionary Forces, Gives an Exceptionally Good Talk on the War

Much and very good material has been written on the war, but there is nothing like looking into the face of a man who has been through it and hearing him tell the story. Major Donald Guthrie, who spent thirty months with the Canadian expeditionary forces on the Belgian front, told some of his experiences to the Hawthorne employees on the evening of October 26, and his talk gave a vivid idea of life where the big guns never hush.

The major avoided all descriptions of the terrible tragedies of the trenches, confining his lecture to instances showing the wonderful morale of the allied armies and to descriptions of the methods employed to keep the men as comfortable and cheerful as possible. And they are cheerful, even under the most adverse circumstances. Major Guthrie told of an Irish soldier having a piece of shell removed from his head. The surgeon noticed it was from an English grenade and asked the man how he happened to get wounded in such a way.

"Will," answered the Irishman, "'twas loike this, sor. Oi was invoitid to go on a little raidin' party, an' on the way home Oi got lost in No-Man's-Land. Sure, Oi wandered around quoit a whoile, an' at last Oi come onto an advanced post av the Boches. They was severial av thim in there, principally occypoid in kapin' quoit, so Oi shlipt oop rather quoit mesilf an' Oi trun 'em down a big roipe bomb, sayin', siz Oi:—'There, dum yez. Dayvoid thot amongst yez. An', sor, they did thot same, the gin'rous divvils, aven savin' a pace av it fer me, sor.'"



The Supervisors of the Finishing Department All Ready to Finish Off Their Annual Banquet on November 3rd

The Liberty Loan at Hawthorne

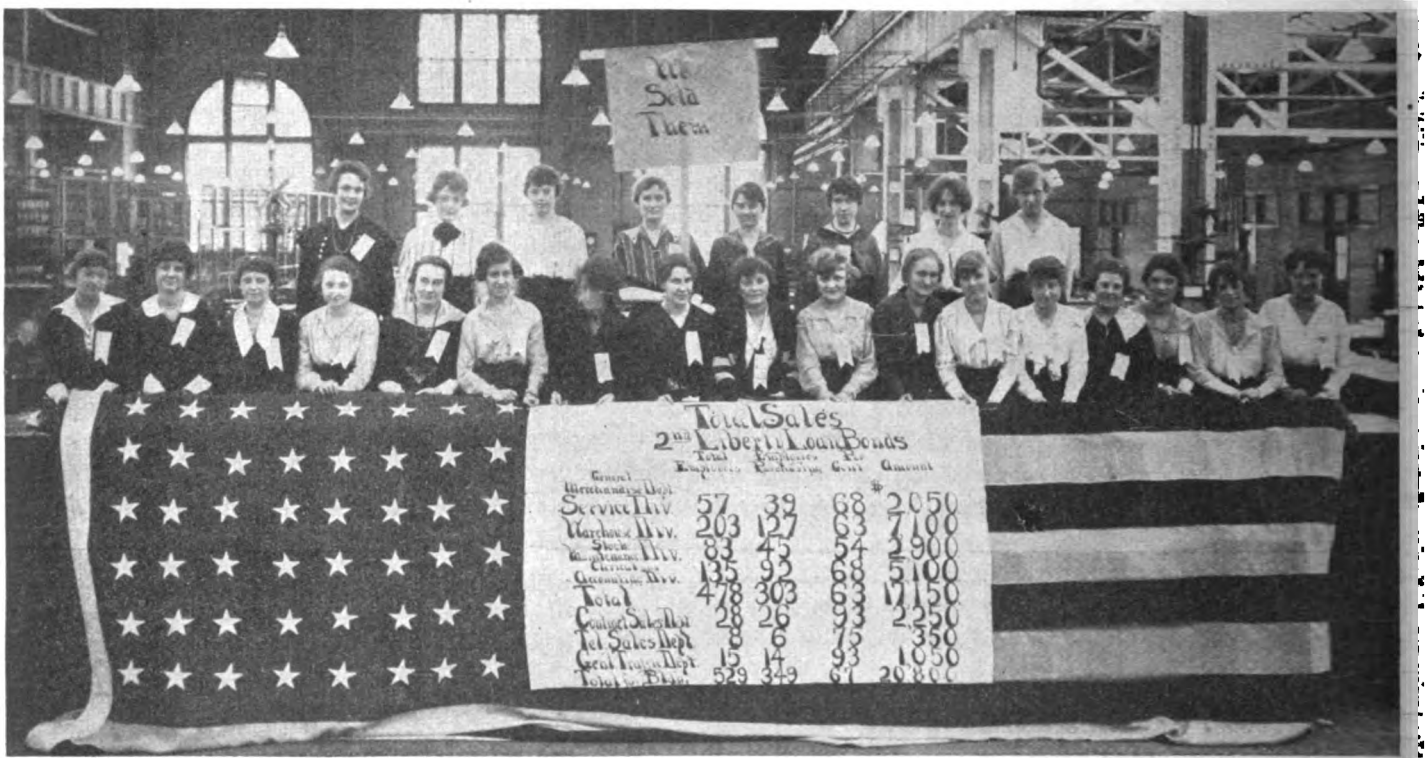

General Merchandise Department Girls Who Helped to Float the Liberty Loan

“**E**TERNAL vigilance” used to be “the price of liberty,” but, like everything else, it costs more now “on account of the war.” “Watchful waiting” no longer fills the bill and Uncle Sam has learned that he must roar with a 42-centimeter bellow if his appeal for justice and humanity is to penetrate the deaf ears of the Kaiser.

Now, beating the Kaiser at his own shell game costs money, but every sane, just, normal human being believes that it is worth every cent it costs. Consequently, the second Liberty Loan found everyone willing to do his bit. Those who subscribed for a bond under the Company’s plan signed up for one bit every working day and two bits every Sunday, making a total of eight bits or one dollar a week. At the end of 50 weeks they get a \$50 bond. Those who pay double that amount per week get two \$50 bonds, and so on.

Here is the way the subscriptions came in at Hawthorne after the plan was announced:

	TOTAL	TO DATE
Monday, October 15.....	\$2,800	\$2,800
Tuesday, October 16.....	2,800	5,100
Wednesday, October 17.....	8,800	13,400
Thursday, October 18.....	23,850	37,250
Friday, October 19.....	27,600	64,850
Saturday, October 20.....	24,050	88,900
Monday, October 22.....	60,700	149,600
Tuesday, October 23.....	34,100	183,700
Wednesday, October 24.....	63,250	246,950
Thursday, October 25.....	67,600	314,550
Friday, October 26.....	211,550	526,100

Special showings were made by many of the departments—so many, in fact, that the News has not the space to tell about them all—but the General Merchandise departments presented figures too attractive to be

overlooked. That, of course, means that they are too attractive not to be looked over. Help yourself to the illustration. The ladies are all single.

How Atlanta Helped the Loan

Don't delay your Subscription to the Second Liberty Loan

DEPARTMENT	MONDAY		TUESDAY		WEDNESDAY		THURSDAY		FRIDAY	
	P	R	P	R	P	R	P	R	P	R
ATLANTA WAREHOUSE	221	1 379	2 410	1 413	2 410	3				
TELEGRAPH SERVICE	164	2 220	5 350	3 353	6 343	4				
TYPEWRITING	153	3 212	6 269	8 308	8 345	9				
SHOP	124	4 271	3 289	7 294	9 294	10				
NEWORLEANS	186	5 106	12 108	12 108	14 227	11				
TELEPHONE SERVICE	733	6 394	1 394	2 443	1 468	1				
TRAVELING SALES	66	7 200	7 320	4 333	5 346	8				
OFFICE SALES	65	8 152	9 174	11 196	11 199	14				
SUPPLY SERVICE	629	9 252	4 314	5 314	7 370	5				
OFFICE SERVICE	20	10 126	11 205	6 356	3 400	2				
BIRMINGHAM	0	11 0	13 0	13 160	13 200	13				
NASHVILLE	0	12 183	9 183	10 270	10 348	6				
SAVANNAH	0	13 0	14 0	14 347	4 347	7				
ACCOUNTING	0	14 143	10 190	9 190	12 212	12				
TOTAL AMOUNT		\$5,000	10,550	12,350	13,000	15,250				

PERCENTAGE OF SUBSCRIPTION TO WEEKLY SALARIES

FRANK



Are you a PATRIOT? Have you bought your LIBERTY BOND?

Western Electric News



VOL. VI
NO. 11



JANUARY
1918

Digitized by Google



THE EAGLE'S BROOD



Written by ROBERT F. DE FOREST, of the Kansas City House

We come, O men of bleeding France,
To do our bit, to fight, to share;
Our Eagles sweep the reddened seas,
Swift-winged and true they cleave the air
And over all the Grand Old Flag,
Torn from arches of the night,
Streams like a splendid oriflamme
Above the battle-hosts of Right.

Beleaguered comrades, hold the line!
The flag is coming, shining still
As when it shone at Lexington,
As when it gleamed at Bunker Hill.
The flag for which your Lafayette
And Rochambeau drew sword and lance
Is flying now for those who fight
For freedom and for stricken France.

O brothers in the common cause
Of liberty beyond the seas,
Lift up your eyes and catch the gleam
Of Glory streaming in the breeze!
Somewhere along the far-flung line
Of trench and barricade it shines
In warlike splendor, red and white
And blue above the battle lines.

The Eagle's wings are spread for flight,
Once more is born its warlike mood;
Somewhere in France the Eagle's Flag
Is carried by the Eagle's Brood.
God save the Flag, that those who die
May not have fought and died in vain;
God give our Eagle's Brood the strength
To win—to save the Flag from stain!

* * * *

Oh spacious days of glory and of grieving!
Oh sounding hours of lustre and of loss!
Let us be glad we lived you, still believing
The God who gave the cannon gave the Cross.
Let us be sure amid these seething passions,
The lusts of blood and hate our souls abhor:
The Power that Order out of Chaos fashions,
Smites fiercest in the wrath-red forge of War.
Have faith! Fight on! Amid the battle-hell
LOVE triumphs, FREEDOM beacons, ALL IS WELL.

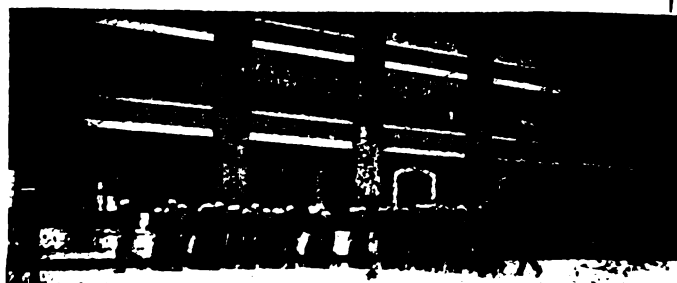

Western Electric News



BOARD OF EDITORS

Editor in Chief, P. L. Thomson
Associate Editors: W. F. Hendry, W. E. Leigh, S. W. Murkland, E. C. Estep, H. D. Agnew, S. S. Holmes, F. W. Willard
Assistant Editors: William Jabine and Reed Calvin

Subscription: \$1.50 per year, except to employees of the Western Electric Company, to whom copies are furnished free of charge. All communications and contributions should be addressed to WESTERN ELECTRIC NEWS, 195 BROADWAY, NEW YORK. Matter intended for any given issue must reach New York not later than the 12th of the preceding month.

VOLUME VI

JANUARY, 1918

NUMBER 11

What It's Like at Funston

By Reed Calvin

A HAND gripping your arm startles you from your slumbers and you sit up suddenly in your berth, only to remember too late that the bottom of a Pullman "upper" is even a little harder than the sleeping side of the "lower." While you are thanking a kind and foresighted Providence for putting such a generous supply of bone in your skull, a soft apologetic voice brings you back to wakening understanding.

"You wanted Funston, didn't you, sah?" it says. "We'ah due at five-thutty, sah."

"All right, George," you say. "What time is it now?"

"Foh fifty-fawve, sah," replies the porter.

"Four fifty-five!" you grumble as you pile out from under the covers. "Why, George, I could have you arrested for waking me at such an hour and robbing me of my sleep this way. There are laws against stealing, you know."

George grins a dutiful quarter's worth at your feeble attempt at humor and you stumble to the wash room to hurry through your toilet before the train pulls in.

Five-thirty A. M. is dark in Kansas this time of the year—dark and decidedly cold. You step off the train and are stopped by a bundled-up sentry. However, he does not stick a bayonet against your chest, as you have half expected he would. In fact, he is much less formidable than the omniscient gentlemen who snap out information at you in the big railway stations. From the sentry you learn that you cannot get into the camp without a pass and that you cannot

get a pass until the office opens at seven o'clock. So you go into the railway station and begin a period of watchful waiting that makes you wonder how President Wilson's patience ever lasted as long as it did at that tedious game. You while away most of the time wondering whether you have enough means of identification about your person to prove that you are not a German spy, and whether they will shoot you at sunrise in case you haven't. About the time you reach such a condition of ennui that you don't care much whether they do or not, you take the ten thousandth look at your watch and find that the office should be open. A reconnaissance outside shows that it is.

Thanks to your natural expression of almost imbecile honesty—(or perhaps due to the Western Electric trademark on your letter of introduction) you have no difficulty whatever in securing a pass from the courteous young soldier in charge of the office. "Just go down the road about 300 yards to the next road that crosses the railway tracks," he directs. "Company A, 314th Field Signal Battalion, is in Barracks No. 727, about the second from the end of the road."

You thank him, take your pass, and start off. By this time it is light enough for you to see Camp Funston—that is, it would be if it were not for the Kansas dust that fills your eyes. In fact it fills everything. You swallow so much of it you wouldn't dare to eat an apple for fear a seed might slip down and take root in your midst. Between gusts of the

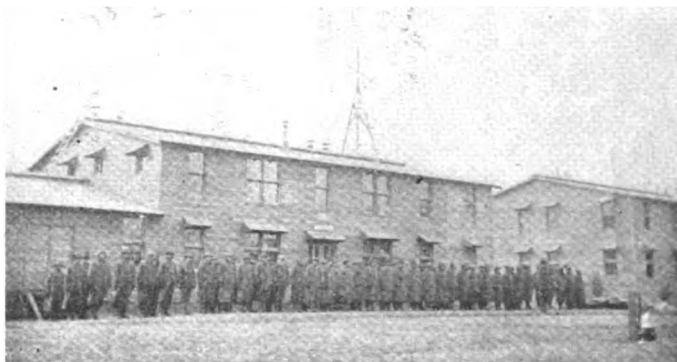

Company A, 314th Field Signal Battalion (the Hawthorne Company) in front of its barracks at Camp Funston



Heliograph Drill. Lieutenant Pratt in Charge of Squad



Some of the Hawthorne Boys Helping to Build the Medical Detention Camp



Going Into Action With Wringer and Tub



Captain P. P. Brinkman



They Don't Work All the Time



Mess Kit and Army Shoes



A Little Wig Wag Work



Mess Sergeant Norton and His Four Cooks



The Hawthorne Company's Orchestra



Hawthorne Signal Corps Boys Welcome a Cable From Home

WITH THE BOYS AT CAMP FUNSTON

driving wind, though, you are able to catch a few glimpses of Camp Funston. All of its beauty, you find, is in your eye—dust. It consists of a flat dusty plain surrounded by squatty hills, bare of vegetation and resembling the huge heaps of earth excavated from mines. The site is built over with hundreds of plain board buildings, one and two stories high, arranged along well made or partly finished streets. Here and there tall steel smoke stacks rise from the heating plants. That is all, except for hundreds of mule-drawn wagons, motor trucks, touring cars and motorcycle "bath tubs," sharing the roads with companies of soldiers on their way to the drill grounds, the rifle ranges or the training trenches.

Yes, They're Glad to See You

You lower your head again to the blasts and the next time you look up, joy! you are in front of Barracks No. 727. You skip up the steps, two at a time, and find yourself in the best looking spot in all Kansas. My, how good it seems to see those Hawthorne boys! Apparently they are equally glad to see you. "Is the old place busy? Lots of work, eh?" "How's John Krivanek and the other boys in the drafting department?" "Say, is Milly still in the coil winding department?—Little girl; sits near one of the posts; got light hair; kind of thin."

You assume the last description applies to the girl, not the hair, and you answer this and dozens of other questions to the best of your ability until you get a chance to slip in a few of your own. Of course the first is: "How do you like soldiering?"

Well, it seems soldiering is a great business—teaches a man self-control, makes him form regular habits, compels him to eat the right kind of food, etc., etc. One of the boys proudly declares that he has gained 20 pounds since he joined the army. All of them appear to be in the best of health.

Next you "wonder if you could look over the barracks a bit." Can you! Nothing pleases them better than a chance to show the place. It is heated by a couple of big furnaces, one in the mess room and a second in the bunk room. You recognize these terms as meaning dining room and bed room, respectively, and begin to feel that you are something of a military man yourself.

Just now the bunk room is not oppressively warm, for all the windows are up with the bedding protruding through for an airing. The bunks are small iron cots similar to a hospital cot, only lower—about the regular bed height. Every soldier is his own chambermaid—"wash-lady" too, for that matter—and our boys have become so adept at making beds that they could black up their faces and qualify as Pullman porters any time.

The mess room looks like a picnic grove eating place with a roof over it—same long pine tables, same benches for the diners. It even has what looks like the coffee booth—a counter at one end, with a stove, sink and other kitchen facilities behind it. This space is the mess room kitchen, in charge of Mess Sergeant Norton. Erickson,

the regular cook—and he is a regular cook, too—is cleaning out the stove. Buchard, the other cook, is out on sick leave and his place is being filled—to overflowing—by Private Peters, who must weigh about 200 in the shade. He is a good advertisement for any kitchen. Then there is Private Jackson, who is on "kitchen police." That does not mean flirting with the cook, as you might be led to infer from your knowledge of city patrolmen's habits. It about corresponds to the job of scullery maid. The duties include such pleasant little tasks as peeling potatoes, washing dishes, sweeping and scrubbing floors, polishing pans, etc. Everyone gets a turn at it every so often, and, if he doesn't behave, oftener. Most Hawthorne girls will appreciate dish-washing as a very effective means of punishment.

Having seen the kitchen you wonder what the boys get to eat. The mess sergeant explains that it is something of a problem to give them a variety of nourishing food with an occasional delicacy and still keep within the Government allowance. For today he is serving a breakfast of chipped beef on toast, flaked hominy, stewed prunes, bread and coffee with milk. Dinner will be pork and beans, stewed peas, boiled potatoes, bread and tea with milk. The supper will consist of purée of tomatoes, salmon salad, hashed brown potatoes, fried-cakes, bread and tea with milk. Which is very good fare for less than forty cents a day per man. The old H. C. of L. may drive some of the rest of us into the army yet. Everything, of course, is bought from the commissary department at Government prices. A pound of bread, for example, costs about four cents.

Drill, Drill and Then More Drill

And now you want to know what they do all day. It seems that they drill and then drill and after that they drill. The program includes marching, heliograph practice, semaphore and wig-wag flag signaling, and telegraphy. Besides their regular work they are also helping construct the medical detention camp. Sergeant Starner has a detail over there now.

In the evening, after "working hours," they have great times. In fact, the fame of these has spread abroad in the land. Proudly they show you a "write-up" in the National Army News, a paper published for the camp. As you read you don't wonder they are proud of it.

"Talk about your corps spirit! It is Company A, 311th Field Signal Battalion, that has it," says the article. "It is doubtful if there is a company in camp that is characterized by such good feeling and harmony."

"There are few of the boys who wander from the barracks fire-side, because Company A has a picnic all the time it is not on duty. The company is wonderfully musical, and has just added a piano to its many other musical instruments. But it is not only in instrumentation that A excels. It has a glee club and a quartet, consisting of the following members: John Jurgens, baritone; Harry Lennon, baritone; George Daugherty, tenor, and J. F. Fisk, bass."

"The barracks has something doing nearly every night, and although it is located near the northeast corner of the camp and is distant from hundreds of other barracks, it never lacks a big crowd of visitors, for there are so many barracks which lack the disposition or the talent to put up a company entertainment. The fine company orchestra plays, and the boys from other parts of the camp drop in until the barracks is full. And Company A likes to have them come, for it is filled not only with the spirit of music, but of good fellowship."

You throw out your chest as you read it. You are from Hawthorne, too, so a little of their glory belongs to you, also.

By the time you have finished looking over the barracks it is noon, and those of the Company not on kitchen police or special details are back from the drill grounds, hungry for dinner. You dine at the officers' quarters with Captain Brinkman and Lieutenant Pratt.

After the meal the lieutenant bids you good-bye. He is going "into the gas" that afternoon. Oh, no; it's not that serious. He expects to get back alive, all right, but not until too late to see you before train time. "Going into the gas" is part of the gas-mask drill. The men are subjected to all the various noxious gases unpopularized by the Germans. Tomorrow it will be Captain Brinkman's turn.

In the afternoon the captain takes the company out to the drill grounds and puts them through their paces for you. He also lines them up and you try to get some pictures of them between dust swirls. The pictures turn out rotten, which is just what you expect.

By this time you are so thoroughly filled with Kansas shivers that you go over to visit the telephone exchange as an excuse to get indoors. Camp Funston has 400 lines in operation, handled by six Western Electric boards. A seventh is on the way. All the wiring throughout the camp is underground. Thirty-five thousand feet of Hawthorne-made cable was used on the job. It varies in size from 400 to 25 pairs. One hundred and thirty-five thousand feet of No. 17 twisted pair



Camp Funston in the midst of a Kansas dust storm. The building marked with the single cross is the barracks of the Hawthorne Company. That marked with two crosses is the officers' quarters

was used in wiring up the various sub-stations. Our installers, by the way, cut over the switchboard installation in just 18 days after they started work.

There are many more interesting things to hear about the system, but before you have time to take them all in you notice a clock which says you will have to hurry if you want to get the evening train back to Kansas City. So you rush over to the barracks, say good-bye to the boys, grab your bag and hurry for the station, swallowing most of the state of Kansas on the way. You don't care for anything more to eat that night. Added to that, the Chicago train is four hours late at Kansas City.

Still, what do you care? You have had a chance to see the boys.

E. C. Higgins Who is Training Men for the Signal Corps



Capt. Eugene C. Higgins

WHEN the War Department began to take stock of the resources of the country, in order to throw the entire weight of the nation most effectively against the enemy, the officials found a great shortage of telegraph and radio operators. Thousands of these operators would be needed for the Signal Corps. They were not available, so Colonel Wildman, department signal officer of the Central Department, was directed to train 5,000 men in the fifteen states comprising that department—men of draft age only—so that when they should be called through the regular operation of the draft they would be partially trained for signal corps work. To this end the educational department of the signal corps was established.

The department needed as a directing head a man who not only had a deep knowledge of electrical affairs, but who was a successful educator as well. The Government

officials thought the Western Electric Company might have such a man. It had. The post was offered to Eugene C. Higgins, of the educational department at Hawthorne, who accepted and was commissioned a captain, assigned to duty as assistant to the department signal officer.

Since his appointment Captain Higgins has organized numerous schools in the Central Department with over 4,000 registered men enrolled.

The training of the registered men for signal corps service is carried on largely in night classes, in co-operation with educational institutions and patriotic organizations. It is estimated that more than 15,000 men skilled in telegraphy will be needed. The quota to be trained under Captain Higgins was put at 5,000. A large number of students from these classes have already offered themselves for enlistment and been accepted for service.

Captain Higgins is an electric engineering graduate of Iowa State College and has been with the Company ever since his graduation in 1902. He was connected with the engineering and sales organizations before taking up work in the educational department.

Company A, 314th Field Signal Battalion

(Hawthorne Radio Company)

BRINKMAN, PAUL PARMELEE, Captain

PRATT, HAROLD STEELE, Lieutenant

Adams, William Duncan
Aiken, Robert Blaine
Aldridge, John Albert
Barth, Frank
Beckley, Charles Otto
Bergman, William
Bolton, Frederick Tindale
Bouchard, William
Brand, William Carl
Chlad, C. H.
Clusack, Stanley C.
Combs, R. L.
Cothran, Hayes
Daggett, Charles Leroy
Devine, John Francis
Dougherty, George Turner
Ellis, Edward
Erickson, Walter John
Esping, George Alfred
Fisk, James E.
Gerber, George William
Gieseler, Arthur
Harkins, Ralph James
Hartmann, Williams Joseph
Herion, C. A.

Hintz, Leroy Franklin
Hoffman, Frank J., Jr.
Jackson, Henry S.
Jannenga, Nicholas Louis
Jelinek, Robert Edward
Jewell, John Fielding Faut
Jordan, Homer Glenn
Jurgens, John F.
Kistler, Charles
Kripner, Frank
Kummerow, G. H.
Lennon, Harry Degener
Levy, Alfred L.
Logan, McGrady Lange
Lopata, Frank F.
Masa, John Frank
Masek, George Paul
McArdle, William Joseph
Meinhard, Herman Henry
Morency, George A.
Mosher, Allen
Norton, Edward J.
Mueller, Adolph Frederick
Munson, Charles Harold
Peters, Lewis Albert

Petrzelka, James John
Psutka, Charles Joseph
Rattenburg, Fred
Reynolds, Richard A.
Ribal, William John
Richards, Harry
Roake, Homer B.
Ryan, Herbert Joseph
Sampson, Harry Nichols
Schultz, W. C.
Sezech, Edward Michael
Siegenthaler, Jacob Lewis
Sindelar, George Francis
Smith, Frank Robson
Sperling, John G.
Starnes, A. J.
Story, Keith John
Sullivan, J. J.
Tichy, Arthur James
Trojan, Joseph
Van Nest, Gilbert Robert
Warner, Oscar
Weiler, Walter W.
Williams, G. J.
Zachary, Sanford Vernon.

Company A, 319th Field Signal Battalion

(New York Radio Company)

PRATT, GEORGE C., First Lieutenant

ROHRIG, FREDERICK A., First Lieutenant

SERGEANTS

Kloth, Harold W.
Van Tubergen, Geo. W.
Helwig, Eugene C.
Gahan, John J.
Brown, Thomas
Gates, Wilton, J.

CORPORALS

Vroom, Edward
Johnson, Herbert B.
Peters, Karl F.
Thaxter, William J.
Gordon, Percy D.
Atwood, Robert
Cruger, John C.

Timmerman, Stanley G.
Reenstra, Albert J.
Ayers, Harry C.
O'Connor, Milton, R.

PRIVATE—1st CLASS

Best, Gerald M.
Bergstrom, Arthur M.
Cervený, Albert L.
Croll, Chauncey
Dorothy, Leland E.
Grice, George F.
Palmiter, Louis B.
Peck, Guy D.
Singer, Emanuel
Southwick, Laurence F.

Taylor, William E.
Wild, James R.

PRIVATEES

Berran, Frank J.
Goble, Alfred L.
Hunter, John F.
Keller, Jacob C.
Kennelly, Martin J.
Landy, Walter A.
Lott, Mervin R.
Miller, Charles W.
Moreau, William M.
O'Neill, John F.
Pfan, John H.
Stephenson, Joseph J.
Victor, Leonard B.

Members of New York Radio Company Called to Active Service on September 4th Now with the Division of Inspection and Research in France

Christen, A. B.
MacDonald, W. A.
Newell, C. W.
Price, A. F.
Carpenter, Wm. C.
Lack, Fred R.
Von Zastrow, Curtis G.
Ash, John E.
Olson, Wm. A.
Price, C. S.
Wilson, Clarence E.

Crawford, Walter G.
Bollinger, W. A.
Graves, Charles G.
Yeomans, L. D.
Bair, Ralph S.
Ranges, John E.
Haggerty, David D.
Weils, C. A.
Waite, W. H.
Lynch, J. J.

DeStefano, A.
Dring, A. W.
Kerr, M. B.
Adams, J. J.
Kellum, W. W.
Morse, A. E.
Goebel, A. C.
Grey, J. J.
Inglis, A. H.
Jeanne, P. A.
Leigh, A. H.

The New Yorkers Out in Ohio

Company A, 319th Field Signal Battalion, Once of West Street and Broadway, But Now of Camp Sherman and Chillicothe

By William Jabine

"HIT the floor, fellows! Make it snappy! Are you up, Cerveny?" That is the ritual with which Top Sergeant Harry Kloth begins each day in the barracks of Company A, 319th Field Signal Battalion, recruited from the ranks of the Western Electric Company's workers in New York and now training at Camp Sherman, Chillicothe, Ohio. There is just the right combination of friendly urging and firm authority in Sergeant Kloth's voice as it rings out in the early morning shadows while the last notes of the bugles die away, and in less time than it takes to tell it the members of Company A are out of their bunks. Even the reluctant Cerveny emerges from under his warm covers. There are only a few minutes for dressing before another bugle call demands the presence of the entire company in front of the barracks, for no matter what the weather all must line up outdoors for the first roll call just as the sun begins to rise. Company A is ready for another day of Army life.

Perhaps an apology is due to Private Cerveny for labeling him as a laggard, because, as a matter of fact, he is one of the most willing workers in the outfit and has an enviable reputation as a wireless man, but there is not a man in Company A who would not object vociferously if this description of its daily awakening did not contain the personal exhortation addressed to Cerveny. It has become a tradition in the Company that the question, "Are you up, Cerveny?" must follow the plea to "Make it snappy," and if Sergeant Kloth should forget it, even Cerveny himself probably would feel that something was radically wrong.

An extensive knowledge of military affairs is not necessary to produce the fact that the next thing on the day's schedule is mess, and the introduction of that

subject brings upon the scene Mess Sergeant Tom Brown, late of West Street, but before that a traveler to the remote corners of the earth as Equestrian Director of Barnum and Bailey's circus. He is slated for the job of taking general charge of the Company's horses when those animals arrive, that is if his success as a mess sergeant does not create an unescapable demand that he stick to his kitchen. Present indications are that he will find it a hard job to break away.

It may be that other companies at Camp Sherman have mess sergeants as good as Sergeant Brown, but you cannot convince the members of Company A of that fact. He gets the sum of about forty cents each day with which to feed each man in the Battalion, and he makes that forty cents do wonders. Not only does he provide three meals from that infinitesimal sum, but he manages to save a little of it against, not the proverbial rainy day, but against a holiday. Only the coming of Christ-

mas caused the boys to cease talking about the feast he laid before them on Thanksgiving Day, and no higher tribute can be paid to his skill than that.

In addition to being a good mess sergeant, Tom Brown happens to be one of a little group of older men in Company A who make it part of their business to help the youngsters over the rough spots; to show them that life in the Army is not as hard as it sometimes seems, even under the best of conditions. "Tell us a story, Sergeant," is the plea that is made to him again

and again by the younger boys as he sits reading on the edge of his cot in the barracks. It is an appeal that never is met by a refusal. If there is any dialect of which Sergeant Brown is not a master, the boys of Company A have failed to



Lieut. Roehrig on the Left and Lieut. Pratt on the Right. Both are Wearing the Sam Browne Belt, Which is Required at Camp Sherman, But Forbidden Nearly Everywhere Else



Company A, 319th F. S. B., Lines up Before the Camera. Even the boys on Kitchen Police Took Time Off for the Picture



Mess Sergeant Brown



Top Sergeant Kloth



Sergeant Van Tubergen

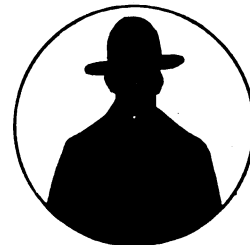

Sergeant Helwig

discover it, and as the tale goes on the others all gather around until when he reaches the end every man in the barracks joins in the shout of laughter that fairly makes the windows rattle. Many a case of homesickness has been cured by one of Sergeant Brown's stories.

Probably a due regard for military precedence would require that Lieutenants Pratt and Roehrig and Acting First Sergeant Kloth receive extended mention before the praises of Sergeant Brown are sung, but no one knows better than do those three men how much the big mess sergeant has helped in maintaining the morale of the Company. It is safe to say that not one of them will object when he finds that Tom Brown's name leads all the rest in this article.

As for the two Lieutenants, they are only commissioned officers, and, as this article concerns itself chiefly with the men, they will have to wait their turn. Now, for Top Sergeant Kloth. It takes only a stay of a few minutes in a military organization of the United States Army to discover the importance of the First Sergeant. He is the man who runs the Company, under the general direction of the officers, of course, but to a much larger extent than the civilian realizes the actual management of the Company's daily affairs are in his hands. And right here it may be said that Sergeant Kloth possesses a most capable pair of hands and an equally capable brain. It is his duty to make the assignments to the various details, some of which involve the performance of none too agreeable tasks, and to do that without making enemies is a job which calls for all the skill of a diplomat. To the credit of both Sergeant Kloth and the men under him is the fact that no matter how unpleasant the job to which a man is assigned, his unvarying reply is "All right, Sergeant," as he goes out

of the orderly room. There are no slackers in Company A despite the fact that it has been getting along at about half strength, which has resulted in making each man do about twice as much work as he would be called upon to do in a full company of seventy-five men.

But a word or two more about Sergeant Kloth. He is the supreme authority during the hours when the officers are across the street in their quarters or elsewhere in the Camp. He has a vast amount of records to keep, and, all in all, is the busiest man in the outfit. He believes that when the boys are doing anything they should put plenty of vim and pep into their work, and when they hear that cry of "Make it snappy, fellows!" the soldiers of Company A all know that it is up to them to keep on the jump if they want to please their Top Sergeant.

There are four other Sergeants in Company A: George Van Tubergen, Eugene Helwig, John Gahan and Wilton Gates. Sergeant Van Tubergen might be fittingly described as the Company's most diligent student. In his hours of rest he generally has a book in his hand and it usually is a text book dealing with his military work. That doesn't mean that the Sergeant is always studying; he doesn't need to do that, but he wants to learn as much as he can before the big trip to France begins. He is one of the two or three men from the General Departments at 195 Broadway, nearly all of the Company being from West Street. Sergeant Gahan is a wiry fellow who saw service on the border in Texas, and military life is an old story to him. There are few things which surprise or worry him; he sits on his cot in the corner of the barracks and reads his newspaper just as calmly and contentedly as if he were in his own home.



The Boys From New York Bundled Up and Ready for a Hike at Camp Sherman With the Thermometer at Ten Below Zero. Lieutenant Pratt in Command. The Hike Usually Comes Right After Breakfast and Puts the Men in Fine Shape for the Day's Work



Nearly all of the Non-Coms of Co. A. 319th F. S. B. From Left to Right they are, Standing, Corporals Cruger and Gordon, Sergeants Brown, Van Tubergen, Kloth, Helwig, Gahan and Gates, Corporal Thaxter. Kneeling, Corporals O'Connor, Reenstra, Vroom, Atwood, Timmerman and Ayers



Corporal Vroom Reads the December News, While Private Dorothy Shines His Shoes. On the Left, With His Pipe in His Mouth, is Private O'Neill, and the Other Four to the Left of Corporal Vroom are, in Order, Corporal Cruger, Privates Landy, Hunter and Stephenson

Sergeant Helwig is never content unless he is doing something, and one of the things he did in his usual efficient manner was to take some of the photographs which illustrate this article. There isn't much danger that anything will go wrong while Sergeant Helwig is around; his eye is too sharp to let anything get by. He is a sort of volunteer guardian for the youngsters; gives them good advice in a friendly way that causes them to heed it, and plunges into every task that is assigned to him with an enthusiasm that is contagious.

Gates is the Supply Sergeant and carries the key to the room which shelters all of the Company's spare material. If anyone wants an axe or a hammer, he has to go to Sergeant Gates to get it, and the tall Sergeant, who happens to be a 195 Broadway man, has to keep careful account of everything that goes in or out of his supply room. He was in the Company's accounting department, however, before he took up military life, so keeping track of Company A's supplies is mere child's play to him.



Private Peck illustrates the correct way to hold a mess kit when the mess call sounds. Note the knife, fork and spoon tucked into his pocket. He is wearing the fatigue or working uniform

So much for the sergeants. The corporals come next, eleven of them: Edward Vroom, Herbert Johnson, Karl Peters, William Thaxter, Percy Gordon, Robert Atwood, John Cruger, Stanley Timmerman, Albert Reenstra, Harry Ayers and Milton O'Connor. Although three of them, Corporals Thaxter, Gordon and Ayers, are not Western Electric men, having been added to the Company since it reached Camp Sherman, they have fitted in so well that the fact that they did

not belong to the original group is now almost forgotten.

Corporal Vroom is a quiet young man who hopes that when he gets back to West Street he will have a chance to do research work. That is the direction in which his tastes lie, and by the irony of fate one of his assignments at Camp Sherman was to the remount station, where he and Sergeant Gahan were enrolled in a course in that branch of military science known as "mule skinning." One of the first lessons in the "mule skinning" course is to take a halter and wander out into a field, in the hope of catching one of the mules which are standing around daring anyone to lay hands upon them. Corporal Vroom's first attempt was highly successful, for he caught his mule and then saddled him without any excitement whatsoever. The job done, he stood up to turn over his mule to the Regular Army Sergeant who was doing the instructing, whereupon that individual, after inspecting the animal, remarked: "Good for you! That's the critter that kicked me half way through the fence yesterday." Even an Army mule has mercy upon a beginner. Incidentally, the "mule skinning" assignment includes a walk clear to the end of the camp, considerably more than a mile, and it must be covered four times a day. It is much like going to school in the country in the old days, according to Corporal Vroom and Sergeant Gahan.

Famous among the soldiers of Company A is Corporal Timmerman, and best of all the tales about him is the story of his visit to the waterworks on the hill behind the Camp shortly after his arrival at Chillicothe. The waterworks are sacred territory, of course, but that never occurred to Corporal Timmerman, who had his camera with him, and even the challenge of the sentry



The Raft Which Sergeants Gahan and Van Tubergen and Corporals Vroom and Atwood Helped to Build



They are Spelling "W-E BOYS" and from Left to Right they are, Privates Stephenson, Hunter, Singer, Cervený, Moreau and Taylor

failed to impress him as it should have done. Thereupon the sentry decided that he was unable to deal with Corporal Timmerman and summoned his Captain, who was not far off. Up walked the officer, and Corporal Timmerman lost no time in beginning a conversation. He was about half way through an observation about the weather or some kindred topic, when the Captain snapped out: "Don't you know how to salute?" "I know a little bit about it," was the Corporal's nonchalant reply, but history records that before he retraced his steps down the hill Corporal Timmerman was able to do far more than his bit when it came to saluting.

There is another Corporal who deserves especial mention. That is Corporal Cruger, one of the big boys of the outfit. Probably because he thinks his thatch of red hair gives him a sort of priority wherever fires are concerned, Corporal Cruger insists on taking care of the stoves and furnaces. One man is supposed to be on fire detail all of the time, but whenever Corporal Cruger is not otherwise occupied the man on fire detail doesn't have to worry. He knows that the Corporal will keep after the fires, and this holds good even in the early hours of the morning. The Corporal isn't happy unless he can get up a few minutes before Reveille and stoke the big stove in the center of the barracks. He has another important use. His folks at home keep him supplied with candy at the rate of two or three boxes a week, and each box is passed around about as soon as it is opened. Here, by the way, is a little hint to those at home who want to send something now and then to the boys at Camp Sherman. They don't get much sugar, so candy is always welcome, and a sure way to gain their affection is to keep their stock of sweet things replenished.



Privates Hunter and Landy Shovel a Little Snow

Corporal Atwood is the Company's leading jokesmith as well as the man responsible for the cartoons which accompany this article. He made the sketches upon the express condition that the readers of the News

should be told about a typical Regular Army Sergeant whom he and Sergeant Van Tubergen encountered when they were assigned to the "mule skinning" school so feelingly described by Corporal Vroom.

"That fellow believed that nothing was impossible," declared Corporal Atwood. "The first day we went down there he found that a couple of freight cars on a siding were cutting off some of his light, so he ordered us to move the cars. We looked around to see where the locomotive was, but that wasn't his idea at all. He expected us to move the cars by hand, and so about a dozen of us had to go to work and do it. I never knew before that joining the Army meant that you had to act as a locomotive every now and then.

"Another time he wanted us to get some willow sticks to put in pack saddles. All the good sticks on this side of the river had been used up, so the Sergeant ordered us to build a raft. We built it all right, and one of the fellows here has a picture of it. Believe me, when that Sergeant wanted anything done, you did it."

Company Clerk is Corporal Reenstra's title, and he helps Sergeant Kloth in the orderly room. He comes from the Newark house.

If there only were space enough, it would be possible to prolong this article until it occupied every page of the January issue of the News. There is room enough, however, to tell something about some of the boys who are enrolled as privates, because, as everyone knows, an Army without any privates wouldn't be an Army at all. For example, what would Company A do without Private Dorrothy, the outfit's best business man. He has built a wooden chair, which is set up in the barracks, and conducts a thriving shoe polishing business with all of his comrades as customers. His inseparable companion is Private Peck, who always bunks beside "Dot" and lends his aid now and then when his chum has more work than it is possible to handle alone.

Then there is Private Best, a Cornell graduate, who finds time to do the repair work on all the motion-picture machines in camp as well as run some of them for the Y. M. C. A. He also is the Company's



Bugler O'Neill as he will look when he learns to blow his little horn



The Trio from the Repair Shop. From Left to Right, Private Best, Corporal Cruger, Private Singer



No, its not a 'Shot in the arm,
He's just finished a days K.P.

chief musician and can play any instrument in existence, his comrades say. It is hard to tell whether he is more proud of his set of five ocarinas or "potatoes," with which he hopes to organize a Company orchestra, or his wrist watch to which he applied a Western Electric telephone finish before he left New York. When he gets back from France he will be able to tell them up at West Street just how their No. 75 finish stands up under the rigorous test of modern warfare.

"From sales clerk to cook, don't forget to put that down," was Private Croll's injunction. He comes from the Buffalo house, and now in company with Private "Stretch" Palmiter is helping Sergeant Brown in the kitchen. Every other morning one of the pair has to get up at 8 A. M., but little things like that don't bother them. Before he could persuade them to become cooks, however, Lieutenant Pratt had to assure both Croll and Palmiter that their work in the kitchen would not be allowed to interfere with their advancement as radio men. That shows the kind of ambition that animates the soldiers in Company A.

When he learns to play that instrument, Private O'Neill is going to be the Company's bugler. At present he makes periodical excursions to one of the empty barracks, where with other embryo buglers, he practises to his heart's content. It is reliably reported that no sentry is needed to keep intruders away from that particular barracks during the "music" hour.

Privates Taylor and Wild achieved fame shortly after they arrived at Camp Sherman through their eccentricities of apparel. Taylor, who just can't shake off the reputation of being the laziest man in the Company, invented the Camp Sherman helmet on his way West in the train. It was an abbreviated Derby that even

Charley Chaplin would have been ashamed to wear and created a veritable furore when he reached the Camp. Even the officers whom he met as he walked about could not conceal their mirth. Wild, who is a big fellow, came in late the day the uniforms were distributed and the result was positively painful. He acquired a hat that perched on top of his head ready to roll off at a moment's notice, a blouse that left his arms uncovered from the elbows down, and trousers that would have looked all right on wee Johnny O'Neill or little red-headed Martin Kennelly. Until he got straightened out, anyone who wanted to laugh merely looked at Wild.

Private Southwick blazed his way to fame by another route. He has a deep-rooted aversion to those rude persons who like to take liberties with his name, and the other boys insist that if General Glenn himself should, by a slip of the tongue, say "Private Lampwick," Southwick would at once reply heatedly, "No, *stupid*, my name is Southwick." At all other times, Southwick is a model youth.

But this article began by attempting to describe a typical day in the life of Company A at Camp Sherman,



The Hat that Made Camp Sherman Smile, and
Private Taylor Under it

and has wandered far from its intended course. It is high time to get back, although all who have read the Camp Funston article which precedes this know just about what the daily life at Camp Sherman is like. In these days of uniforms and uniformity, one cantonment is just like another. No, there is one difference—the boys at Camp Sherman don't have to wash their own clothes. The Camp laundry attends to that. After breakfast comes a cross country hike with Lieutenant Pratt or Lieutenant Roehrig in command. Then follows a lecture in the mess hall by one of the officers, after which the boys settle down for an hour of practical telegraph instruction. Visual signalling and other forms of dismounted drill are next on the program, and they take up most of the time until the noon mess call sounds.

In the afternoon more visual signalling and dismounted drill fills a couple of hours. An hour is then devoted

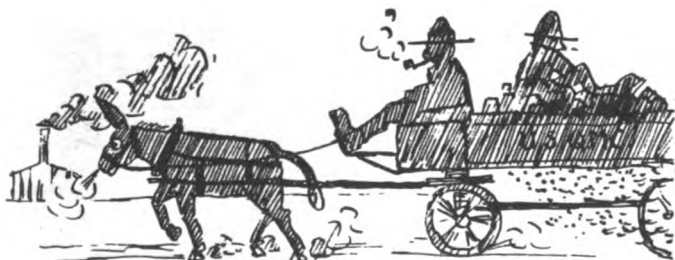

The Coal Detail.

to recreation under the supervision of the officers. The always impressive ceremony of Retreat comes shortly after four o'clock these Winter days, and the entire battalion stands silently in front of the barracks while from every direction the bugles can be heard and the flag at Headquarters flutters down. There is a school for the non-commissioned officers in the evening, but the other boys sit around the barracks where they read, sing, listen to Private Best's violin, or one of the mandolins. Some go off to one of the Y. M. C. A. houses.

And the boys of Company A, like the soldiers in camps all over the country and in France as well, cannot say too much in praise of the work that the Y. M. C. A. is doing. "Don't forget to put something in the News about the Y. M. C. A.," was the request that was made by almost every man in the Company, and it is impossible to let such a request go unheeded. The service that the Y. M. C. A. is rendering in this great war is immeasurable. It never will be forgotten by the soldiers and sailors who have found a firm friend at a time when such a friend was most needed.

Taps ends the day at half-past ten, and before the last light is out most of the boys are fast asleep, and only wake when the bugles blowing Reveille summon them to another day of Army life.

A word or two about the history of Company A. It was organized by the Western Electric Company last July and was recruited up to full strength, seventy-five men. A school was provided by the Company, with P. I. Wold in charge, and everything went well until Fall when the remarkable progress in radio work made by the Western Electric Radio Company came to the attention of the Signal Corps of the Army. At that time a Division of Inspection and Research was in process of formation and as a nucleus for this division the Signal Corps took Capt. McGrath, who was made a Major, and about thirty men from the ranks of the Western Electric Radio Company.

These men were sent to France at once and their sudden departure made necessary a practical reorganization of the Radio Company. Then came a long period of waiting for orders, which was very trying to the men, and it was a rather discouraged group of thirty-seven soldiers who finally received word that they were to report at Camp Sherman. Since they arrived at the

Camp they have made splendid progress despite the fact that they have been compelled to move to new barracks several times.

The present commander of the Company is Lieutenant G. C. Pratt, the Secretary of the Western Electric Company, and second in command is Lieutenant F. A. Roehrig, who comes from the Pacific Coast. It is expected that the Company will soon be recruited up to full strength, but even the influx of outsiders is not likely to destroy the fine Western Electric spirit which is so pleasing a feature of Company A, 819th Field Signal Battalion as it is at present constituted.

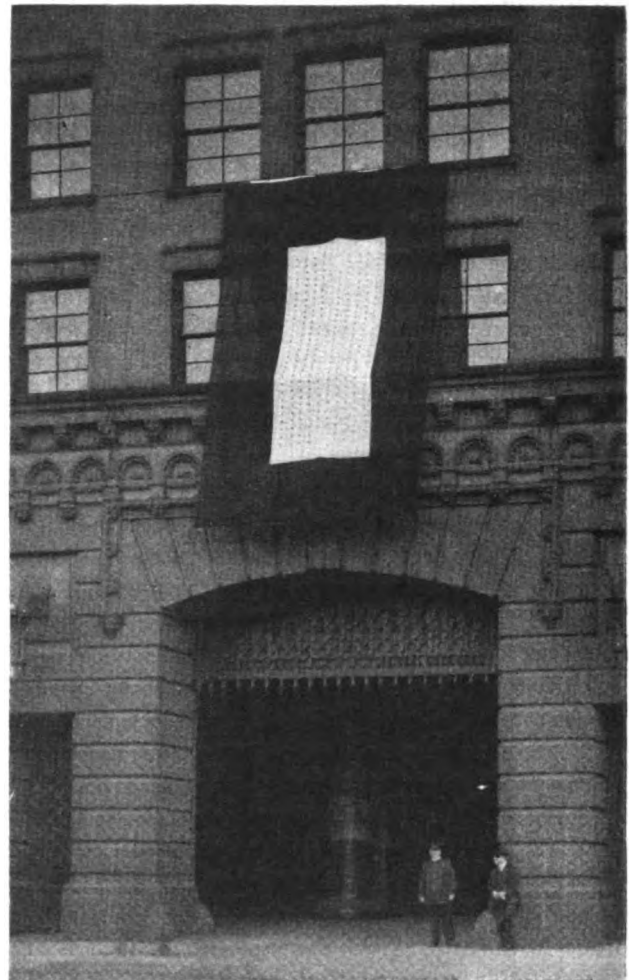

The Service Flag Which Flies From the West Street Building in New York. It Contained 884 Stars at the Time the News Went to Press

To Our Soldiers and Sailors

With one voice, the Western's Daughters
 Give a long and rousing cheer—
 For our men in Blue and Khaki
 At the dawn of this New Year.
 Trusty Soldier, Gallant Sailor,
 Heroes of our land and sea,
**HAPPY NEW YEAR, CROWNED WITH VICT'RY,
 SAFE RETURN TO W. E.!**

E. M. T., Boston.

Curtailing the Muse

The snappy title which appears above this paragraph was written by W. A. W., of New York, for a poem which he contributed to this issue of the News. The poem was eight lines long and was nothing more than a rhymed statement that as this issue of the News is a Service Number W. A. W. was willing to do his "bit" by contributing twelve lines to the Company's soldiers and sailors. All of which was a trifle obscure until a personal interview with W. A. W. disclosed the fact that his invariable custom is to write poems of twenty lines, and that by boldly casting precedent aside and writing only eight, he was giving twelve lines to the aforesaid soldiers and sailors. Upon being apprised of this the editors of the News resolved that W. A. W. should not outdo them in generosity and have therefore curtailed the muse completely by deleting W. A. W.'s eight lines.

The Law and the Profits (Understandable Talks on Accounting)

Some Facts on Real and Fictitious Profits and How They Are Distinguished

By L. M. Nichols

THE Law and the Prophets went hand in hand in Biblical days. Thereafter they seem to have parted company, only to reappear now as the Law and the Profits. This present-day "Comeback" was staged by some of the leading performers in the Industrial World with E. N. Hurley (then of the Federal Trade Commission) as Prophet and Impresario. In his "Awakening of Business," Mr. Hurley sounded the keynote of economic and financial reform, which the Western Electric Company and others had for years been carrying out on their own account, and which in large measure has made their financial structure able to stand the shocks of such economic earthquakes as 1907-8 and 1914. Built on solid rock and not on shifting sands these corporations came through unimpaired.

Perhaps the laws that guide us in keeping our profits like Ivory Soap, 99 44/100% pure, will be clearer if we go behind the scenes a while with our profit makers and refiners, and trace the profits through the various stages from the raw material to the finished product. (The latter, by the way, in the best circles comes out in the form of dividend checks.)

The simplest conception of profits is the "difference between what we take in and what we pay out," but like all simple cut and dried rules of the thumb this is exceedingly dangerous in its alluring simplicity, a veritable Lorelei for the over-optimistic voyager on the uncharted seas of business. Let's examine some of the rocks and reefs that we and others of the enlightened have been able to chart and avoid.

First, we must observe a few fundamentals, kindergarten stuff, such as "Look not at thy assets through rosy-hued glasses." Many a firm has figured the year's winnings with no regard for the depreciation in its buildings and machinery that inevitably grow old and in a relatively few years must be replaced—and then the unhappy directors, facing huge expenditures for new equipment with an attenuated bank balance, begin to find "silver threads among the gold."

Our aforesaid Prophet, E. N. Hurley, tells us that 90% of the business firms in America have no fixed policy of depreciation. If they have a good year, why surely they'll write a bit off the plant account. If the year has been of a Jack Spratt variety—to wit, a lean one,—why they'll have their li'l dividends first, and then, if the platter is licked clean, the subject of depreciation is, like Count von Luxburg, a *persona non grata*.

Another case of "counting one's chickens before they are hatched" is the valuing of the merchandise inventory at selling prices instead of at its cost. This amounts to taking the profit on the goods before they are actually

sold, and is a doubly vicious practice if done at the end of a poor selling year when the stock of finished goods has piled up because it was desirable to keep the factory uniformly busy. Think of the wailings and gnashing of teeth the next year when this stock becomes obsolete and shop-worn, a "white elephant" of an investment tying up necessary working capital, and finally has to be disposed of at a sacrifice.

Next, we have to tackle a diplomat's job in valuing the I. O. U.'s in our possession, varying in form from "gilt edged" three name notes to open accounts (some of them too much so), and the rather mythical Loan Accounts which, like love at first sight, are subject to pretty heavy depreciation. Our credit department keeps our books very free from "undesirable aliens," but once in a while an embryo business man, with mind untouched by the teachings of our prophet, goes bad on us, and we write him off of our books into the hands of our attorneys. We have no desire to put ourselves in the ambiguous position of John Henry Brown, who, after numerous delicate hints to a chronic "friend" (in a financial sense), finally came out flat and said, "Bill, you owe me five dollars." Says Bill, "All right, John Henry, call it that," and thus it became a Deferred Receivable.

Having passed Scylla & Charybdis and a couple of other bell-b(u)oys, we may now settle down to a peaceful figuring up of our profits, sure that they are unpolluted at the source. Since the Western Electric Company is a jobber through its distributing houses as well as a manufacturer, we have several sources of profits. We'll start with the inner works (the shop) and work out into the open as illustrated in the diagram on the opposite page.

The only trouble with the first two mentioned items of Profit—Shop Surplus and Engineering Surplus—is that they may be very, very good or very, very horrid; in the latter case they are no longer surpluses but deficits, whereupon they blush for themselves and appear as red figures. To follow "System's" time-honored method of attack, let's see "How a Surplus may become a Deficit."

It is manifestly impossible to figure actual costs each day on each item or lot manufactured in the Shop, so, on the basis of past experience, a Standard Cost is figured for each kind of apparatus manufactured and all quantities of each kind that are completed in the Shop are charged into Completed Merchandise, at Standard Factory Cost. At the end of the year, the totals charged out to the General Merchandise Department at Standard Factory Costs, divided between Labor, Material, Expense Loading and Engineering Loading, are compared with

the actual expenditures for these items, and then we face some hard facts.

Perhaps through pressure of work it has been necessary to work overtime paying the workmen sometimes 50% higher rates per hour, or, due to large numbers of inexperienced or inefficient workmen, the output per man falls off. As such conditions were not contemplated in the normal allowance for Labor in our Standard Cost, we have a deficit in the Output Account.

Worse yet, with prices of copper and other raw materials skyrocketing, the normal material allowance in our Standard Cost is about as adequate as a clergyman's salary in the face of the High Cost of Living, and a life-sized Raw Material Deficit springs into being.

In these busy times our experience with Expense Loading is usually a happier one than with Labor and Raw Material, for since the loading yields a greater amount of camouflage to cover our expense as our output gains in volume, and since in expense there are certain fixed charges that do not mount so rapidly as the output, we are likely to find ourselves possessed of a tidy little surplus from Expense Loading. On the contrary, when the lean years come, we have our factory still with us, with depreciation and taxes on all of it eating merrily into an Expense Loading, that has gone down with Output as surely as the thermometer sinks with sunset. Of course we have normal years like the years of innocuous desuetude, 1910-1913, when efficiency in operating expense has full play and we tuck away neat surpluses in the old sock against hard times to come.

Similarly our Engineering Loading (not including the Annual Picnic) in active years overtops the actual expenses of the Engineers and we have an Engineering Surplus.

The General Merchandise Department, like many other grasping middlemen that we know of, has a "cinch." Just think of it; charged at Standard Cost, they can always charge it out to the Distributing Houses at Interhouse Prices, which allow them a margin as fixed and certain as death and taxes. The Interhouse Prices, by

the way, approximate the costs of similar apparatus to our jobbing competitors, so that our houses have a commercial margin of gross profit on which to operate. They correspond with the costs to the Houses of merchandise bought from outside suppliers.

During the year our Houses don't know exactly how much gross profit they're going to find in their coffers at the end of the year, but for current use we resort to some highly scientific estimating, as told by a confrere in the News just a year ago. Like all delicate machines, this method of estimating may give occasional weird results if somebody throws sand in the gear box. Witness the historic instance when a branch house during the year had been religiously estimating 40% Gross Profit on Cash Sales, and then woke up somewhere in

Dreamland in January and found that in Cash Sales had been included sales of old and overstock disposed of at heart-breakingly low prices. In the resulting effort to figure the percentage difference between an estimated 40% Gross Profit on a selling price that represented a great loss on the actual cost and the actual profit the Comptroller's representative demolished an expensive slide-rule. Such differences between our infallible estimated profits and the incontrovertible actual profits are productive of the so-called "Leak Inquiries." So perish the "False Profits."

Out of these Gross Profits the Houses must meet their Local Expense for Administration, Sales, Stores and Financial purposes and a General Expense charge to cover the Supervision and Services received from the General Departments, before they can sit down and figure up their net profits. In years within the memory of man these have by no means been "sad days of reckoning."

The balance of our General Expenses, which we have not been able to assess against the protesting houses, has to come out of the other Company Gross Profits enumerated above.

Thus we arrive at the Net Profits on Sales earned by the sweat of our combined brow. To our already overflowing (?) coffers, we add other income which the framers of tax bills sometimes regard as privileged, i.e.,

The Progress of the Profits

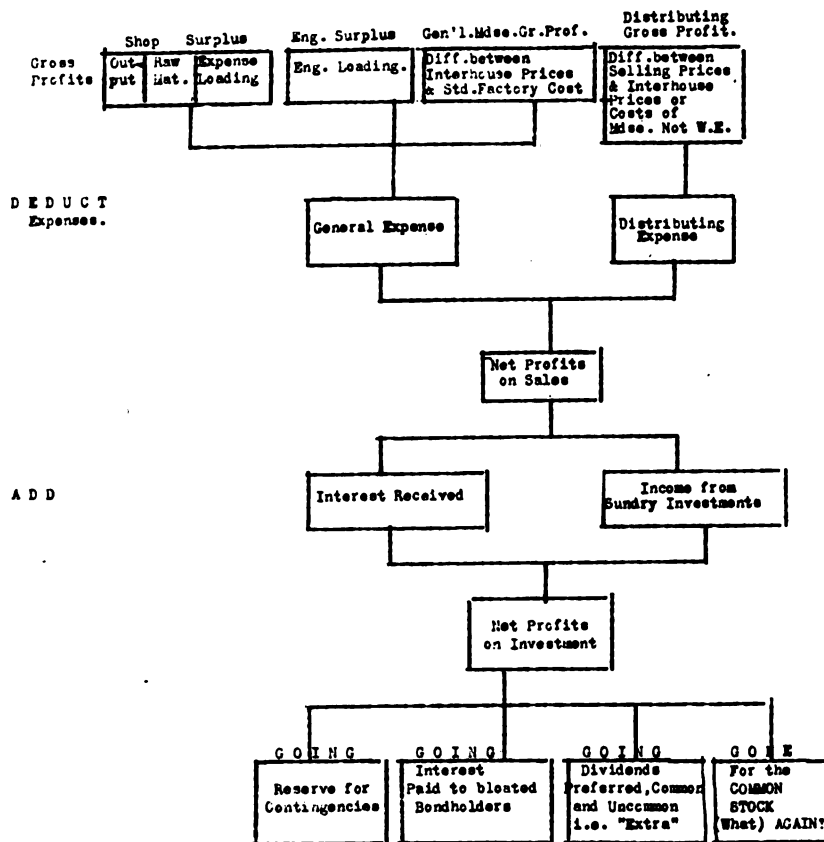

This Chart Shows the Main Events in the Life of the Company's Profits from the Cradle to the Grave

Interest Received and Income from Investments. Imbued with a proper Harry Lauder spirit, we tuck away provisions against a rainy day, a flood, a fire or other act of God or our competitors. Behold the Reserve for Contingencies, a very present help in time of trouble.

To him who hath shall be given, so the bloated bond-holders get theirs, before the bourgeois Preferred

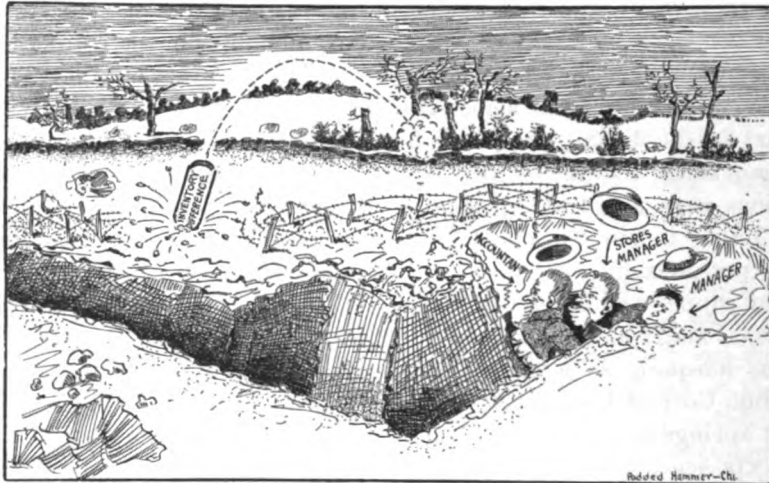

In the Front Line Inventory Trenches Getting Set for the Big Explosion Will They Lose Their Dear Little Profits?

Stock holders or utterly plebian Common Stock even have a look in.

Like the auctioneer, we'll close the sale of our wares: "GOING, GOING, GONE." Look who's here. The apple is gone and behold there's a core (the camouflaged Surplus). The Commoners score again. Well, why not, in these days of Russian Revolution with the Bolsheviki in the saddle.



From an Old Customer's File

WESTERN ELECTRIC MANUFACTURING CO.
220-232 KINZIE STREET.
CHICAGO.

AUGUST 4, 1879

CHAS. B. MC DANIEL ESQ.

GORNING

IOWA

DEAR SIR:---

YOURS OF THE 3-ND INST IS AT HAND.

IN REPLY WE QUOTE AS FOLLOWS:

6 X 8 GRAVITY BATTERY, 50 CELLS OR MORE AT A TIME, EIGHTY-FIVE CENTS PER CELL. OUR JARS WEIGH THREE POUNDS EACH, AND THE ZINCS THE SAME.

INSULATED WIRE, 50 POUNDS OR OVER AT A TIME, FORTY-FIVE CENTS PER POUND.

PORCELAIN INSULATORS, IN BOXES OF 500 EACH, TWO AND A HALF CENTS EACH. BORDERS FOR SAME, MADE ON PURPOSE, WITH SHORT THREAD, FIVE-EIGHTHS OF A CENT EACH.

NO. 18 GALVANIZED WIRE, TEN MILES OR OVER AT A TIME, SEVEN AND FIVE-EIGHTHS CENTS PER POUND. THIS IS BARNHURST & MOEN'S BEST BEST WIRE, LONG LENGTHS.

IF YOU ARE GOING TO A PLACE WHERE IT WOULD BE AN ADVANTAGE TO SHIP WIRE FROM WORCESTER, MASS., WE CAN SHIP FROM THERE SOMEWHAT CHEAPER THAN FROM HERE.

LET US KNOW WHERE YOU ARE GOING, SO THAT WE CAN TELL SOMETHING ABOUT THIS.

YOURS TRULY,

WESTERN ELECTRIC MFG. CO.

Welles

This Letter Was Written More Than Thirty-eight Years Ago. The Man Who Signed It Was F. R. Welles, Who Later Was the Company's Vice-President in Europe. The News Is Indebted to the Recipient, Charles W. McDaniel, for Permission to Publish It

War Tax Law of 1917

MANY of our employees are directly affected by the War Tax Law of 1917, and every one whose yearly income amounts to \$1,000 or over should carefully study the requirements of the law to determine whether he must report his income to the Government and whether or not he must pay a tax. Heavy penalties are provided for failure to comply with the law.

Every citizen or resident of the United States having a net income of \$1,000 or over (a married person living with husband or wife, only if having a net income of \$2,000 or over) must file a return, that is, he must report his income to the Collector of Internal Revenue in the district where he lives or has his place of business. The return must be filed on or before March 1 and must cover the entire preceding calendar year. The first return is due March 1, 1918, and forms may be obtained from the Collector of Internal Revenue.

The Company is required to report to the Government the name and address of every employee to whom it has paid \$800 or over, and any employee who has not kept a record of the amount of salary or wages received, or who wishes to verify his figures, may obtain the information from the Pay Roll Department about February 1, 1918.

The tax assessment is based on the return filed with the Collector of Internal Revenue, and the tax for the year 1917 is payable to him on or before June 15, 1918.

Me and the Manager

Did you ever stop to realize, if you sit in the manager's chair, And held the position that he does, the respect that is his while he's there? He has worries of which we know nothing and our mistakes are his mistakes, too. He must fight for us all, and right all our wrongs, so I think we are lucky, don't you?

MRS. N., Omaha.

Western Electric Men Who Are Helping the Government—J. W. Dietz

WHEN you think of the hundreds and thousands of men entering the new National Army from all walks of life, you can readily understand the problem which faces the military authorities in their work of organizing the various arms of the service in each division at the National Army and National Guard cantonments.

When the camps opened the adjutant's department of the War Department was ready to tackle the big problem. A civilian "committee on classification of personnel in the Army" with a representative at each of the National Army camps had worked out a plan whereby a comprehensive occupational and educational census could be made. The object was to carry the selective law to its logical conclusion and thereby increase the efficiency of the Army by putting the right man in the right place. A personnel office in charge of an Army officer has been established at each camp. These officers are serving the Army much in the same way that our centralized employment departments get men on jobs where their previous education and experience can be used to the best advantage.

Information on each enlisted man is gathered—full details regarding his previous occupation; just how long he has worked at it; and what schooling and experience he has had to help make him an expert in his line. The data collected are used within

each camp by the division commanders in making the best possible assignment of their men. The information also is of importance in locating men fitted for special branches of the service, such as the signal corps, ordnances or aviators.

Of course, it is not possible for most men to continue in their old occupations in the Army. The function of the Army is fighting and most of the men irrespective of their previous occupations, will be in the infantry and artillery; but the specialization of modern war requires such large numbers of expert men adapted for technical and special branches of the service that the problem of locating and placing such experts to the best advantage is of vital importance. Professor Walter Dill Scott, of the bureau of salesmanship research, has been very active on the work of the personnel committee. Professor Scott is well known at Hawthorne, where he gave a series of very interesting discussions on personal efficiency a year or two ago. J. W. Dietz, educational director of our Company, was assigned by the committee to help organize the work at Camp Pike, Little Rock, Ark.; Camp Shelby, Hattiesburg, Miss.; Camp Beauregard, Alexander, La. Mr. Dietz found a considerable number of previous employees of the Western Electric Company, especially installation department men, among the officers and men at the camps where he worked.



J. W. Dietz



Branch House Managers as Professors

TWO of the Company's managers, F. H. Leggett, of New York, and J. D. Kennedy, of Philadelphia, have been delivering lectures on the problems with which they are familiar before college audiences. Last August Mr. Leggett gave a series of lectures on "Warehousing" before the students in the Tuck School of Finance at Dartmouth, and last month he gave a similar lecture at the Massachusetts Institute of Technology.

Mr. Kennedy's lectures have been delivered at the Wharton School of the University of Pennsylvania, and the following letter from Lieutenant Richard H. Lansburgh, of the Ordnance Department of the United States Army, shows how much Mr. Kennedy has accomplished:

"I am directed by the Chief of Ordnance to thank you for the co-operation which your firm is giving to the Wharton School of the University of Pennsylvania in the training of men for the Ordnance Field Service.

"One of the most important phases of modern warfare is the proper supply of ordnance material. In order to insure the proper operation of the ordnance storehouses in the field, this Department has sanctioned the establishment of the stores schools at various colleges, among them the University of Pennsylvania, and has looked to these schools for its supply of trained storekeepers and men who will handle the accountability for such stores.

"One of the most important phases in training in these schools is the practical work in representative industrial concerns. Without such practical work it would be manifestly impossible to give proper training.

"By co-operating with the University of Pennsylvania you are, therefore, performing a real service in the proper training of men for Ordnance Field Work and your co-operation is greatly appreciated by this Department."

TALKING IT OVER

THE FLAG ON THE COVER

OUR Service Flag, which appears on the cover of this month's issue of the NEWS, would bear almost 3,000 stars were it not for the fact that a great many employees were so anxious to get into the forefront of the fighting without a moment's delay that they rushed off to the recruiting offices leaving no word behind. Their zeal to serve their country was so great that they thought of nothing else, and as a result their names do not appear on the Company's lists of men who have left to enter military service.

Altogether there are about 600 of these men, and although they are not represented by stars on the Company's Service Flag, the Company wants to put them there, and is making every possible effort to get in touch with them. In some cases investigators have been sent to their residences and before long the Company hopes to have all of them in their rightful places on its Honor Roll.

The fellow employees and friends of such men can be of considerable assistance to the Company in this work of seeking them out. The NEWS takes this occasion to ask the aid of all who know the whereabouts of men in military service who left without apprising the Company of their intentions.

As for the flag on the cover; it includes stars for all the Company's employees, as well as those of our allied houses in Canada and Europe, who are giving their all to win the war.

THE RADIO COMPANIES

IN the belief that the evidence of an eye witness is better than any other, the NEWS sent its two assistant editors to visit the Hawthorne and New York radio companies last month. Reed Calvin spent a day with the Hawthorne boys at Camp Funston, Kansas, and William Jabine went out to Camp Sherman, where the New York company is in training. The story written by Mr. Calvin discloses the fact that he had to wrestle with Kansas dust storms, and the photographs which accompany Mr. Jabine's article give a hint of the below zero weather which he encountered.

Both survived to tell the tale, however, and brought back reports which indicate that the two radio companies are doing excellent work. The men are thriving on Army fare and despite the fact that they work hard every day most of them are gaining in weight. The Western Electric spirit of loyalty and good fellowship is a distinguishing feature of both companies.

SOME UNPUBLISHED LETTERS

A NUMBER of letters have been received by the NEWS from the Company's soldiers and sailors which are not printed on the pages devoted to such news simply because the writers insisted on praising the NEWS itself. It really wouldn't do for the NEWS to set forth its own virtues even if written by its readers. The thanks of the NEWS are extended, however, to each and every one of the men who have taken time in the midst of their busy military life to write these words of praise.

WAR ORDERS

THE NEWS and its readers can afford to wait until we win the war to learn about the work which Western Electric employees are now doing toward winning it. It cannot be denied that the results which have been accomplished have set standards that were undreamed of a few months ago in what now seem like the slothful times of peace. It is the splendid spirit of cooperation that makes it possible to establish new speed records in every department which handles this work. A new year is beginning and by the time it draws to a close even the deeds which now seem so wonderful will be surpassed. That is the Western Electric way of doing things.

ABOUT THE NEW WAR TAX LAW

READERS of the NEWS will find on page 14 of this issue an article on the new War Tax Law, which will affect a great many of the Company's employees. This short statement of the substance of the new law should be of considerable help to those who are liable under its provisions to pay a tax. The attention of employees is called to the fact that although the Company is required to report to the government the name and address of every employee who receives a salary of \$800 or more a year, the individual employees must themselves make returns. The report made by the Company does not take the place of the return which each individual must make.

NEXT MONTH'S LEADING ARTICLE

FOR the February issue the NEWS hopes to obtain a story from Gerard Swope, Vice-President of the Company who has just returned from an extensive visit to the Far East. From time to time the NEWS has published fragmentary accounts of Mr. Swope's trip, but, of course, they have not been as satisfactory as an article from his own pen is sure to be.

Who's Who at Hawthorne



WHO'S rounding into tip-top shape to fight his first big mill (and when he starts it's flowers and crepe for poor old Kaiser Bill)? Who's oiling up his trusty gun to make old Europe hum and give the treacherous murdering Hun a pass to kingdom come? Who gets our prayers and gets our cheers—if needs be, gets our coat (and we will bet three husky beers he

gets the Kaiser's goat)? Who stands ace high in Hawthorne town? Good luck to him, and joy! (You know the answer. Drink it down!)—The Western soldier boy!

When the War Is Over

When the war is over, Heinie,
Just take a tip from me.
There'll be no German submarines
A diving thro' the sea.
For in Fatherland is Kaiser Bill,
The guy we're going to lick;
We'll have a brand new Kaiser
And the same will be a "Mick."

We'll change the song "Der Wacht am Rhine"
Into an Irish reel,
And make the Dutchman dance,
If so inclined we feel.
The police force in Berlin
Will be Micks from County Clare;
When we put an Irish Kaiser
In the palace over there.

Sure, in every German parkway
You'll find a sweet colleen;
And in the fields of sauerkraut
We'll plant the Shamrock green.
No liverwurst or sausage,
When the Dutchman drinks his suds;
But he'll get corned beef and cabbage
And good old Irish "spuds."

The heathens' guns and gas bombs,
We'll throw them all away.
There'll be no iron crosses,
To make the Dutchman gay.
There'll be no more goose-stepping.
Sure, the Shamrocks they will wear,
When we put an Irish Kaiser
In the palace over there.

J. W. D., Omaha.

Even Dallas Sometimes Errs

On a recent order for twenty 20 ft. class "C" creosoted poles with No. 12 treatment, roofed and with three gains, on receipt of the supplier's invoice, we billed our customer for the twenty poles and back ordered the treatment, roofs and gains. We hesitate to say what would have happened had the order reached the warehouse.

S. Z., Dallas.

Lighting Plants Are Often Useful

ONE night recently trouble developed on our lighting circuits here in the office, permitting 220 volts to get across the line. In order to save our lamps and to avoid possible danger from exploding bulbs we had to turn out the current, and while waiting for the shop to locate and repair the trouble, Paul Ramsey, our editor, had a happy thought.

In our demonstrating room we have Western Electric Farm Lighting Outfits installed and Paul, with the use of extension cords, was able to keep on his job regardless of the outside interference, and the bank of lamps used in connection with the demonstration gave sufficient light to enable us to keep going until the trouble was repaired.

W. E. L., Atlanta.

Married

December 1st—Miss Alpha M. Splickan, Department 6031, Hawthorne, to Howard Lancaster, 333rd Field Artillery, formerly of Department 6337, Hawthorne.

November 25th—Claude A. Heiser, Stores Department, Dallas, to Miss Martha Mae Harris, at Dallas.

November 28th—Miss Lillian A. Klumpp, Department 6377, Hawthorne, to John A. Boutrock, of Chicago.

November 30th—Sergeant I. T. Stewart, of Camp Sherman, Chillicothe, Ohio, Cleveland Stores Department, and Miss Helen Fitzgerald, Cleveland Stores Department.

The Bell System's Flag



The Service Flag Which Floats Over Broadway in Front of the Telephone and Telegraph Building. The Figures Show the Number of Bell System Employees Who Are in Service, Including Those from the Western Electric Company

OVERSEAS



The Lackadaisical Lapp

By A. E. Reinke

THE readers of the WESTERN ELECTRIC NEWS would, without a doubt, be interested to hear something about telephone conditions in the Arctic regions. Unfortunately, the telephone has grown to be such an essential instrument of war that any undue interest displayed by a foreigner for the telephone, even in the neutral Arctic regions, is interpreted at once by native guardians as poorly concealed spy work.

So, instead of actualities, I shall dwell on telephone potentialities in these regions, and there are few telephone prospects further removed from the necessity of choosing between a direct line telephone and a party line than the Lapp. The Lapp is a Swede—when he carries a passport. When not he seems to be a Mongolian. He feels so comfortable under Swedish rule that he takes no interest in Wilson's message to the world about the rights of nationalities to choose their own form of government.

The Lapp goes a step further in this world policy, however, and insists on his right to choose the amount of

work that is good for him. That's the keynote to the Lapp civilization. The Lapp's preference for living in the Arctic regions, where the summer is so short that nothing grows except scrub birch, mosses and wild flowers, is due to a generous impulse. He lets the more civilized nations live on good soil to be worked in the sweat of their brow, while he is contented with the barren waste where the question of tilling the soil cannot be raised.

The Lapp has successfully solved the problem of the high cost of living and leads a simple, care-free happy



"WHILE THE WOMEN WORK, THE LAPP SMOKES"



A Lapland Castle

existence. The women do what little work is done. There is, in fact, so little to do that there is none left for the men. "Ladies first" seems to be one of man's most primitive instincts. While the women work the Lapp man smokes and struggles to think out the best way to keep his life simple and free from modern entanglements.

Every Lapp family seems to own two homes: one in the Far North for the summer months and a winter home near the top of the Bay of Bosnia, where the snow is only five feet deep instead of twenty and where the reindeer is able to shovel his way through to the young spring vegetables underneath. The reindeer does the shoveling so well that the Lapp doesn't have to help him. The Lapp therefore is a nomad, who lives off his reindeer, the tourist and the bounty of the Swedish government. The

nomadic instinct of the Lapp can be readily understood by any one who, like me, has spent an hour in his hut. He likes a periodical change of air like any white man.

The hut of the Lapp is remarkable. He selects a site high, dry and rocky, and as far removed as possible from the next Lapp hut; then his share of the work is done. The hut consists of birch poles, set into the ground, tent-fashion; these are covered by birch bark and by a thick layer of sod. There is a hole in the center of the roof to let light in, when smoke is not trying to get out. From the outside the hut presents an excellent example of protective coloring intended presumably to elude the tax collector.

The stove is of charming simplicity. It consists of two stones laid on the dirt floor on which the women build a birch-wood fire. The fire is always maintained: in winter to keep out the cold; in summer to keep out the mosquitoes. The mosquitoes here develop a liveliness stimulated by a short open season that would make their Jersey colleagues blush. The smoke finds its way out through the hole in the roof as best it can. In former times the Lapp spent much of his leisure in speculating on the probable shape of a hole that would let smoke out and not let rain in. The more intelligent now regard the problem as of a metaphysical nature akin to perpetual motion, and they prefer to devote their meditation to more practical problems, such as lightening the work for their women folk. This they can do all day long with a remarkable display of patience and consumption of tobacco.

The equipment of a Lapp presents a remarkable mixture of the stone age and the twentieth century. The equipment is varied, though never so cumbersome that it cannot be loaded on a sled easily drawn by a woman. To maintain his standard of living the Lapp requires about the following: Crude tools made out of bone, roughly shaped wooden bowls and spoons, primitively tanned bear skins and reindeer skins, generation-old black leather pouches to hold food, china cups and saucers, coffee pots and pans, a coffee grinder, an alarm clock, a ratchet drill, a rifle and a Singer sewing machine. One instinctively looks for a National Cash Register and an International Harvester reaper.

The Lapp clearly has no use for an Interphone. Meal-time always finds him within hailing distance of his wife. He will undoubtedly take a regular telephone, however, once convinced that it will lighten housework for the wife. His ready brain would soon discover valuable uses, such as hanging up the laundry on the conductors, cracking nuts with the receiver, leaving the receiver off the hook to start an automatic howler lullaby to put baby to sleep, hanging his cap, fur coat and moccasins on the various hooks and projections usually supplied with a wall set, etc.

The Lapp race is not dying out. They still believe in large Roosevelt families. The baby Lapps are sewed papoose-like into a leather container, serving as cradle, hammock and crate for transportation. They remain in the cradle until they have learned to walk. The boys and girls are dressed alike except for a fiery red tassel sewed



'CRACKING NUTS WITH THE RECEIVER'

to the boy's cap. This is done to avoid embarrassing mistakes, such as putting a Lapp boy to work. The red tassel retains its peculiar charm through the Lapp's life.

The main revenue is derived from the reindeer and from selling home-made articles to tourists who have no use for them. Bone paper cutters, fur tobacco pouches and carved bone-handled knives serve mainly for the exercise of this modern form of salesmanship.

The Lapp is a Christian, though not of the extreme type who goes to Church every Sunday. At least, he says he is a Christian and thus successfully escapes the exhortations of enthusiastic missionaries. He is honest, good-natured and peaceful and, after he has read his morning paper, is quite contented with his simple civilization well removed from the higher and just now more energetic forms further South.

You will agree with me that the average Lapp is not a promising telephone prospect, and that it will be a waste of time to send a telephone salesman into these regions during the next twenty-five years.



Four Lapps and a Dog

More Antwerp Reminiscences

E. B. Manley Tells of His Experiences When the Germans Took the City



E. B. Manley

E. B. MANLEY, who was employed at the Company's allied house in Antwerp when that city was captured by the Germans, as described in the last issues of the NEWS by C. C. Clayton and A. D. Whipple, has just ended a stay of several months in this country, and by the time

this appears will be back at his post as shop superintendent in Paris. Before he returned to France, Mr. Manley wrote for the NEWS a brief account of some of his interesting experiences at the time of the invasion of Belgium by the Germans.

With the other members of the staff of the Antwerp house he departed for Holland when the bombardment grew too hot for comfort, but later on he returned, and a few excerpts from his narrative of those stormy days follow:

"The first Germans I saw were at Merxem, a suburb of Antwerp, where I had to show my papers. They were Marines, and fine looking fellows—every one of them. It was there that I received my first double-eagle stamp on my passport.

"On entering Antwerp proper I wandered about a little before finding at the Governor's Palace, near the hotel St. Antoine, some one willing to take an interest in me, and then it was only a little bantam officer with a monocle and a swelled head, who told me to speak when I was spoken to. After a lively little talk with him I got hold of some more responsible officer, who willingly signed my papers and advised me on several points. The little

fellow had in the meantime become very amiable, and was trying to persuade me to bring my family back to Antwerp. He got out a magnificent military map of Antwerp and the surroundings, on which he wanted me to point out my home. I never saw a more complete and detailed map, and my admiration for it suddenly reminded him that I was not supposed to see this, and he folded it away in a hurry.

"Reaching the factory I found Mr. Clayton and Mr. Whipple, who had preceded me, and Hypolite, the concierge, who had remained. He had taken care of a little girl whose mother had left her in the care of an aunt, who in turn had lost sight of her. This child we found during the bombardment, weeping and clinging to her dog, her only companion. All the rest you know; how the factory was found uninjured, although some 48 big shells had fallen close to and all around it; how my home was standing, but was considerably messed up inside by visitors, and how the ruins of homes were scattered a little everywhere.

"The looks of Vieux-Dieu had changed very much. At the beginning of the war that beautiful avenue of trees leading to Lierre, familiar to all who know Antwerp, was leveled to the ground, houses and all, by the military authorities. My house escaped, not being in the Belgian firing line, but just between two forts. The firing of the Germans had shot away half of a new school, six houses below mine."

What life is like in Paris at the present time also is described by Mr. Manley, who says:

"We have a number of Belgians and several other nationalities in the Paris shop, and splendid co-operation on all sides. We have been able to pretty well satisfy the military authorities as to their output requirements, turning out apparatus for the French, English, Belgian, Russian and Rumanian armies in their different branches.

"It is most interesting to see officers and soldiers of so many different nationalities constantly about. The American soldiers made a most excellent impression, and I shall not easily forget the wild cheering the American contingent received in Paris on the Fourth of July last. At the banquet which we held that day, Joffre, Pershing, Viviani, etc., all spoke, but there was no boasting of what the Allies would do, merely a very determined quiet attitude, a desire of cleaning up a bad job and doing it thoroughly, for the future benefit of all."

A Norwegian Town That Has an Up-to-date Telephone Exchange



A card received from E. A. Brofos. On the other side he says: "Today a Western Electric quarter automatic telephone exchange, having about 1,000 subsets, has been opened in Sandefjord, a town with 5,200 inhabitants. This is presumably the town with the highest telephone development in Europe." The signatures of the Board of Directors appear in the illustration. Sandefjord is in Norway

A. D. Whipple Returns to Europe

After a stay of a few weeks in this country, A. D. Whipple, who, with C. C. Clayton, took charge of the Antwerp house after the occupation of that city by the Germans, has gone back to the other side of the Atlantic. Not to Belgium, however, for he intends to keep away from that country until the Germans are driven out. He will occupy a position at the Company's allied house in Paris for the present.

F. F. Fairman Has a Son

Ordinarily the NEWS does not print notices of births, but when a Western Electric man 'way off in China wants to tell his friends in America about his newly arrived son, he naturally turns to the NEWS for aid in spreading the glad tidings. F. F. Fairman is the justly proud father who sends word from Shanghai that on October 24 a son was born. The youngster weighed 8 pounds 4¼ ounces at that time, according to his parent's report.

A Sample of the Hawthorne Millwright's Work in Repairing Broken Machine Castings

A PRETTY girl's smile makes short work of mending a broken heart, but a broken casting is something very much else again. Castings are a hard lot, and won't even melt at the glowing glances of the



Fig. 1. Chiseling the Break Preparatory to Welding

unfair sex. They are a stiff-necked and stubborn generation, and a few years ago our standard treatment for them was to cast old broken ones into outer darkness and cast new ones in the foundry. All of that was very nice for the junk man, but it cost a lot in time and money.

Nowadays almost any sort of a break can be welded together with an oxygen-acetylene flame. The principle is simple. All you have to do is shape the break with a chisel to form a channel and then melt iron into the channel with the flame from the gas nozzle. However, the trick is not quite as simple as it sounds. A green hand at the job is likely to find himself melting new holes in the casting instead of mending those already there. Or, failing in that, he may get the break nicely mended only to find that uneven heating has warped the casting worse

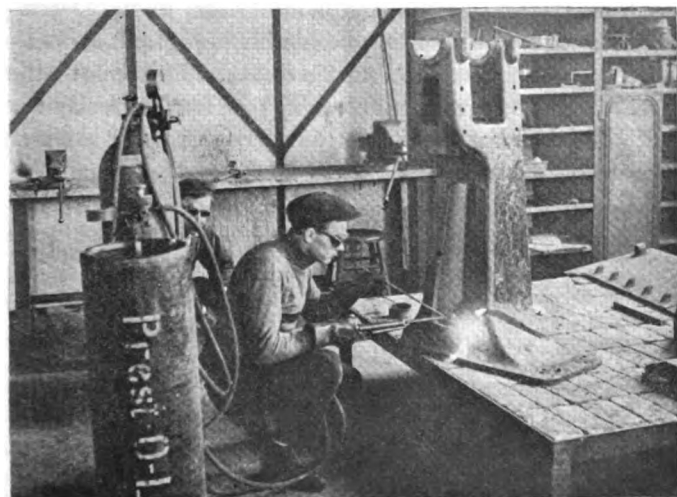

Fig. 2. Soldering the Break With Iron Melted in the Intense Oxy-Acetylene Flame

than the Kaiser's reputation. But with good luck and a good operator it is possible to mend almost anything except a break in diplomatic relations.

Fig. 1 shows a pedestal from the big cable armoring machine in the C., R. & I. Shops, all broken up over the treatment it received from a loose die block on a rampage. This picture and Fig. 2 plainly show the method of repairing the damage. In Fig. 3 the finished casting is shown standing on a couple of bricks, where its weight would tend to open the welds if there were any weakness in them. No, the millwright department does not test them that way. They know the weld is right when they make it. But as copies of the News go to the Kansas City House it seemed wise to prove that point before some one voiced the inevitable Missouri demand. The chalk marks show where the different breaks were.

And one little point more: Nine hundred and ninety-nine people have already sprung that wheeze about the job being weld done.



Fig. 3. The Mended Casting, Placed on Two Bricks to Prove Its Strength. The Chalk Marks Show Where the Breaks Were

Results of New Customers and New Business Contest for October, 1917

THE salesman securing the largest number of new customers during October was:

A. T. Slack, Denver

The salesmen securing the highest number of points or sales to new customers for the period ending October 31st were:

- E. H. Waddington, St. Louis, 1189 points.
- E. K. Brackett, New York, 533 points.
- G. B. Pfeifer, Chicago, 484 points.



Employees Who Have Entered the Various Branches of the Military Service Since the Last Issue of the News

General Sales Distributing

Chicago

WILSON, G. W., Naval Reserve

Engineering Department

BLAND, H., Reserve Officers' Training Camp
 COCHRAN, E., Reserve Officers' Training Camp
 MORTON, C. A., British Army
 RUSSELL, P. M., American Friends' Service Commission
 STANWICK, C. A., Signal Officers' Reserve Corps
 WILLIAMS, F. A., Aviation Section Signal Corps
 WOODRUFF, J. C., Sanitary Corps

General Manufacturing Department

Hawthorne

CURITON, J. G., Reserve Officers' Training Camp
 COONEY, F. E., Reserve Officers' Training Camp
 DUNNE, J., Officers' Reserve Corps
 HIGGINS, E. C., Signal Officers' Reserve Corps
 JANICKI, J., Naval Reserve
 LEBER, J. E., Naval Militia
 KILLACKEY, J. J., United States Navy
 MAYER, P., Naval Coast Defense
 ROBINSON, P. H., Reserve Signal Corps
 SPURLING, E. N., National Guard

News from Western Electric Men in Camp and Field

OVERDOWN WHITMIRE who was called "Otto" by the News last month, a Teutonic appellation to which he most properly objected, is the kind of soldier who likes to talk about the pleasant side of army life. In a letter to one of his former fellow workers in the Atlanta house, he has these good words to say of the food provided by the Government at Camp Jackson, near Columbia, S. C. He is a sergeant in the 402nd Telegraph Battalion, stationed at that camp. He says:

"I was surprised at the way they feed us—always have a cereal for breakfast and on Sundays fruit with it—also ice cream and cake for dessert at dinner. We have hot chocolate and hot tea quite often and always good meat and potatoes.

"I do not have to attend any formations but generally go to one or two a day for the exercise. At present I am discharging the duties of Battalion Supply Sergeant and Sergeant Major with Hix as an assistant. Don't know what they intend to finally give me. I have passed up the third training camp because I consider this better. Lowery is making good as Company Supply Sergeant and also Stepp as cook. Weaver looks after our stock."

Atlanta's representatives in the service of the Government are scattered over quite a territory, but they all are still in the United States. A complete list follows:

J. L. Currie, Camp Gordon, Atlanta, Georgia; Lieut. H. P. Full, Garden City, Long Island, New York; Lieut. John G. Mason, 837th Infantry, Camp Gordon, Atlanta, Ga.; R. B. Moseley, Camp Shelby, Hattiesburg, Miss.; O. Whitmire, 402nd Telegraph Battalion, Camp Jackson, S. C.; H. H. Hix, 402nd Telegraph Battalion, Camp Jackson, S. C.; W. W. Lowery, 402nd Telegraph Battalion, Camp Jackson, S. C.; J. C. Stepp, 402nd Telegraph Battalion, Camp Jackson, S. C.; Lieut. B. Kaufmann, 114th Engineer Regiment, Camp Beauregard, Alexandria, Louisiana; Corporal B. A. Thaxton, Quartermaster's Depot, Atlanta, Ga.; C. V. Weaver, 402nd Telegraph Battalion, Camp Jackson, S. C.; L. Higgins, U. S. Naval Radio School, Cambridge, Mass.; J. A. Laurent, Pierce Hall, Harvard University, Cambridge, Mass.; A. A. Salaum, Camp Beauregard, Alexandria, La.; W. H. Page, Outpost Company, 105th Field Signal Battalion, Camp Sevier, Greenville, S. C.; W. M. Weitzel, Camp Omaha, Omaha, Nebraska; E. A. Wall, Camp Gordon, Atlanta, Georgia.



H. D. Quarles Ready for Flight—Toward the Enemy, of Course

The readers of the News got a glimpse of H. D. Quarles, formerly of the Richmond house, in the December issue. He was standing beside his aeroplane at Fairfield, Ohio, where he is a cadet aviator. This month the News is able to furnish a "close up" of him all ready for flight, and also prints a few paragraphs from a letter received by one of his friends in Richmond.

"I was assigned to a flying instructor October first after waiting for three weeks to be first on the flying list, and had my "Joy Ride" on the same day, which was great. I had expected the thrill of my life but was somewhat disappointed and had no feeling of being up in the clouds until I saw the water tower, which looked about as tall as a pencil.

"On the downward trip the feeling was quite different, the ground looked as if it were rushing up to meet us at a very rapid rate, but the real thrill came about three weeks later when on one fine morning my instructor crawled out of the front seat and told me to take her. I pushed the throttle forward, and after bouncing along the ground for a hundred feet or so, I got her up and it was the most lonesome feeling I ever expect to have. The ship was as light as a feather with the weight of my instructor gone and did some dips and turns which I have tried since to duplicate without success.

"I climbed about eight hundred feet on this trip around the field,

which is quite large, and finally made a landing which did not smash anything, so was put on the solo list, which class I have been in ever since waiting for enough good weather to pass my R. M. A. test."

Here is the way another enthusiastic Western Electric man from Richmond regards Army life. His name is Captain R. M. Dashiell and he is in command of Company K of the 318th Infantry at Camp Lee, Va.



Capt. R. M. Dashiell

"Just a line to say that I am still well and fine, and have got the finest Company in the finest Regiment in the finest Division in the whole army.

"We expect to be here until the latter part of January, and then depart for 'Somewhere.' I will surely get a chance to come to the office to tell all of you fare-well before then, however. Hope to have a visit from some of you at Camp Lee before long."

Corporal E. A. Brunswick, Battery D, 6th Regiment, U. S. Field Artillery, Cleveland's only representative, to date, on the firing line in France, writes very interestingly of his activities with the American Expeditionary Forces. He speaks

particularly about how enthusiastic, contented and apparently happy all the boys are, and of the good work the Red Cross and Y. M. C. A. are doing for them.

In addition to Corporal Brunswick the Honor Roll of the Cleveland house includes the names of Corporal Phil Sherman, U. S. Army, Camp Green; Private F. Kimball, U. S. National Guard, Camp Sheridan; Private A. R. Webber, National Army, Camp Sherman, Edward Spencer; radio operators, Steamer "Huron," Detroit, Michigan, and Sergeant I. T. Stewart, National Army, Camp Sherman.

It is Major John Kick now, and the former farm light specialist is in command of the 405th Telegraph Battalion at Camp Lewis, American Lake, Wash. That it is an organization of which its commander may well be proud is indicated by the following excerpts from a letter recently received from Major Kick.

"For recreation we have an excellent orchestra, 15 pieces, a glee club, dramatic club (minstrels, etc.), a baseball club, and all in all they are the best talented soldiers I ever saw in one organization.

"We were paid first last month because our pay roll was first completed, we have the best mess in the camp as well as the prize winning kitchens and mess halls (cleanest).

"My mess steward is from the Edgewater Beach Hotel, Chicago, orchestra leader is a graduate of a conservatory of music as well as an expert telegraph operator and wire chief. Have 42 of the finest telegraphers in the country, in fact, it is a wonderfully well-balanced outfit of which I am very proud to be the commander."

Another Western Electric man, who is at Camp Lewis, is Carl A. Sanborn, formerly of the Los Angeles house. "We are up here in the Northern wilderness learning the rudiments of infantry drill," is the way he describes it,

and expresses the wish that we could use some Western Electric farm lighting plants "to brighten up the German situation."

F. J. Ashley, formerly of the Service Department of the New York house, is not only a soldier, but a sporting editor as well. He occupies that position on the editorial staff of the Wadsworth *Gas Attack* and Rio Grande *Rattler*, which is the official newspaper of the 27th Division (New York National Guard) at Camp Wadsworth, Spartanburg, S. C. When he isn't a sporting editor, Mr. Ashley is a private in the Headquarters Troop, and when he isn't either he is spending a furlough in New York, a privilege which he enjoyed recently. While in the city he called at West Street.

John Jeskic, who worked in the shop maintenance department at West Street, was sent to Camp Upton, but didn't stay there long. One fine morning he was told that he had been made a camouflager and was packed off to Camp American University, Washington, D. C. He has been working hard with the other members of the Army's first camouflage company and reports that the unusual job is extremely interesting.

The following names have been added, since August, to the Roll of Honor of the San Francisco house:

SAN FRANCISCO—E. Grey, Stock, Field Artillery; C. L. Heisner, Service, Aviation; J. E. Keegan, Shipping, Field Artillery; D. Murray, Stock, Infantry; C. F. Schubert, Stock, Infantry; L. T. Thompson, Service, Engineers.

EMERYVILLE—W. A. Harper, Metal Finisher, National Army; H. A. Ball, Draftsman, National Army; G. H. Barquist, Inspector, National Army; R. Datson, Warehouseman, National Army; E. L. Finley, Subset Repairs, Coast Artillery; C. McPherson, Jr., Subset Repairs, Coast Artillery; C. C. McRae, Machinist, National Army; R. C. Murrillo, Warehouseman, National Army; N. E. Rockwell, Misc. App. Repairs, National Army; A. W. Swenson, Machinist, Coast Artillery; J. E. Trotter, Packer, Naval Reserve; L. Wheaton, Wireman, National Army; H. A. Harkins, Draftsman, National Army; W. McLaughlin, Shop Stock Clerk, Field Artillery; P. Matanane, Wood Finisher, National Army; H. E. Wallace, Inspector, Aviation Corps; A. Dewar, Methods Man, U. S. Signal Corps; E. Schilke, Machinist, National Army; T. Pareto, Warehouseman, National Army; M. Burke, Shop Stock Clerk, Field Artillery; M. Vervais, Shop Stock Clerk, 5th Regimental Band; G. Williams, App. Repairs, Hospital Corps; F. Powers, Chauffeur, Coast Artillery; R. W. Bröwne, Inspector, Ambulance Corps; T. S. Irvine, S.W.B.D. Helper, Field Artillery; C. F. Martin, Shop, Aviation Corps; R. L. Tillett, Warehouseman, National Draft Army; C. D. Williams, Shop Cost Clerk, Aviation; L. M. Ray, Methods Man, Field Artillery; C. J. Carroll, Dismantler, National Draft Army; F. Fontes, Subset Repairs, Field Artillery.

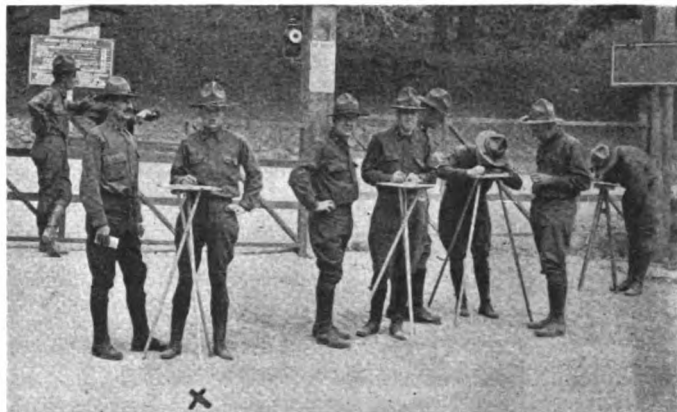

Some California Soldiers. The Man with the X Under Him is Lieut. W. H. Johnston of the San Francisco Stock Maintenance Division

Frank DeWitt, of Department 6505 at Hawthorne, is now a Corporal in the 32nd Company of the Coast Artillery Corps at Fort Totten, one of the defences of New York Harbor. His letter is one of those which might be printed but for the fact that it consists mainly of praise of the NEWS.

From overseas comes a letter written by Charles P. Wagner, who was a member of the installation department at St. Louis. He joined the "Regulars" and is a radio operator with the American Expeditionary Force. Part of his letter follows:

"Life here in the Heavy Artillery, of which the 7th is a part, or unit of, is very fine in its manners and we have had one of the fairest and squarest commanders that could have been given us. (Cannot mention his name). Each man is so elated with the service that the entire regiment, as individuals, subscribed for at least one Liberty Bond, many men taking more. For a regiment in the field and a regiment of the Regulars too, that speaks volumes for what they believe in regard to the cause.

"As for what the Frenchman thinks, I will illustrate. I met one a few days ago who was sporting six stripes on the arm which denoted that he had been 'Put out of Action' six different times by being wounded. He had only the thumb on his left hand and a forefinger on his right. At the time I met him, he was on his way to the front, so becoming curious, I asked him if he could not obtain his discharge. He was much surprised and his only remark was, 'Why the war has not yet ended and I can still shoot with this thumb and this finger.'"

Jo Sorenson, who used to be the correspondent of the NEWS at Seattle, is in the Navy now, and for the present is stationed at Puget Sound, Wash. His way of proving that life in the Navy is not all hard work was to send in the menu for Thanksgiving Day at his post. Lack of space makes it impossible to print it all, although it would make an excellent recruiting poster. Among the headliners on the bill are Roast Yakima Turkey with Cranberry Sauce, Oyster Dressing and Giblet Gravy, Baked Yams, Baked Squash, Baked Spiced Hams, Tomato Salad, Mince Pie, etc., etc.

J. Austin McCall, Supply Specialist, has left the Omaha house and is now at Fort Kelley, San Antonio, Texas, in the Officers' Reserve Corps, Ground School of the Aviation Corps.



Herbert Kitson

The picture which accompanies this paragraph is of Herbert Kitson, one of the many youngsters who have left the Company's service for that of the Nation. He became nineteen years old only a couple of weeks ago. While he was with the Company he was engaged in installation work, chiefly in and about Philadelphia. His parents sent his photograph to the NEWS and in their letter say that he is in camp at Augusta, Ga. When he left home in September he weighed 135 pounds, and now his weight is 160 pounds. Like Jo Sorenson's Thanksgiving dinner menu, that is as good an advertisement as the Army could ask.

A cold day on the rifle range and the pleasures of being the Colonel's Orderly are feelingly described by Thomas W. Conrad, who was a member of the Sales Department at Kansas City before he embarked in the military business. He is at Camp Funston, Kansas, and this is what he has to say. Do not neglect to read the second paragraph.



T. W. Conrad

"It warmed up a little Thursday evening so they decided to go on the rifle range. We left camp 7:00 in the morning; as soon as we had started it began getting colder and to snow a little. It is nine miles each way so we do not come in for dinner but eat out in the open. It got so cold about 2:00 P. M. that our guns would not work and they decided to bring us in (or rather send us in) for we hot-footed it all the way, nine miles, and some blizzard I'm here to tell you—but when a fellow is on his way home he can stand almost anything.

"I did forget to tell you that I was appointed Orderly for the Colonel last Sunday, the job for the most part consisting of taking his bull dog out for a walk in the morning and giving him a bath in the afternoon. I understood it was an honor to be a Colonel's orderly—but I don't want any more, I'm sure."

Another former Kansas City employee, R. F. DeForest, who is with the National Army at Camp Doniphan, Fort Sill, Oklahoma, sums up the reasons for war in an interesting manner. He says:

"The time has long passed when we can ponder over the right or wrong; or, even question the ultimate end. We must accept the whole as one of those mysterious efforts in the progress of world development to produce something better than has gone before. This conflict between two philosophies of life is so vast and so far reaching that it seems to involve the very foundations of civilization. At times we can but wonder, if our civilization is not doomed to disappear like so many others in past ages. Convinced that our interpretation of right is the correct one, we must bend our every effort to make it prevail regardless of personal sacrifice and suffering; each of us willingly or unwillingly, but worthily let us hope, must take his place to answer 'here.' The emphatic belief in the justice of their cause, has caused every nation to arouse its every human passion, to concentrate every device known to man, every invention of mechanical science—to be concentrated on the work of successful slaughter."

The following is the honor roll of the Kansas City house; the men formerly in the organization who are now in service:

G. E. Paxton, formerly in the shop at Kansas City—now at the Great Lakes Naval Training School, Chicago. Corporal T. M. Thornton, formerly in our Warehouse Department—now with the Rainbow Division in France. Lieut. W. E. Saylor, formerly in the office Service Department—now with the Rainbow Division in France. Corporal H. B. Stone, formerly in the Stores Department, Kansas City—now with the Rainbow Division in France. A. J. Osborne, formerly of the Stores Department—now at the Great Lakes Naval Training School, Chicago. R. F. DeForest, formerly of the Kansas City Sales Department—now with the National Army at Camp Doniphan. Lieut. L. G. Gross, formerly of the Kansas City Sales Department—now with the Coast Artillery at Fort Hamilton, New York. T. W. Conrad, formerly of the Kansas City Sales Department—now with the National Army at Camp Funston.

A post card on the back of which is a picture of an aeroplane brings this message from W. D. Koch of the New York Sales Department:

"Newport News, Va.—I was rather high yesterday, about 5,000, not in price, but altitude. Flew with Stinson in this aeroplane doing the loops, dips, etc."

Richard J. Ambler who had charge of the catalog work in the Advertising Department in the days before the War, was commissioned a Second Lieutenant at the close of the second Officers' Training Camp at Plattsburg. After a short furlough he reported for duty at Camp Meade, Annapolis Junction, Md.

John Bischoff, Jr., of the Engineering Department, New York (manual apparatus division), ought to know what a National Army Camp looks like because he has been in two of them. He is now at Camp Gordon, Atlanta, and expects to stay there until he starts for France. His letter gives a good description of a typical cantonment.

"As I said before, the Camp is a city in itself, but of course one can get tired of living in a certain house (barracks) or in a certain neighborhood and move to a more desirable location. But then, on the other hand, the landlord never gets around either for his rent, so there is no desire to move.

"The barracks are arranged to house from 150 to 250 men, and when we are all together we feel like one big family. The structures are two-story buildings. The lower floor is divided into two sections, one of which is sub-divided into two sections, one of which is the kitchen and the other the mess hall or dining room. The last room, besides being used for the purpose mentioned, may be used for entertaining visitors and as a reading and writing room when the lights are out in the sleeping quarters, or when a table and bench are more desirable than a cot and a board. I am writing this while sitting on my cot and holding a board on my crossed knees for a writing table because the mess hall is being cleaned out. The dining room is also used on Sunday morning for holding Sunday School.

"The remaining section of the lower floor contains the Orderly Room and supply room, and a large sleeping section for the men.

"The entire upper floor is used as sleeping quarters. We are all pretty anxious when time for eats comes around, more so in fact than we ever were while living the life of a civilian."

Capt. A. B. Sperry, formerly of the Machine Switching Branch of the Engineering Department, New York, entered the Signal Corps Training Battalion at Camp Alfred Vail, Little Silver, N. J., and after completing the prescribed course was assigned as Commander of the 304th Field Signal Battalion, 79th Division, Camp Meade, Md. A letter from Capt. Sperry reads in part as follows:

"The present Federal Military Movement is on so large a scale that officers to teach and drill the men, and to complete the organization and keep the machinery going, seem to be required in great numbers.

"Yesterday I stood in the back of Headquarters, heard a band playing and looked out. Marching past, four abreast, was a great column of soldiers, with their long winter coats, moving across the bridge, through the pines and over the hill in the gray foggy distance, while back in the rear this same dull-olive colored column extended as far as I could see. I watched this while four different regimental and artillery bands passed, and still the column was the same moving stream as when I first saw it in the misty distance, and turned my eyes back to discover the tail. This is only one camp where an assemblage of American soldiers can be seen like this, but it is sufficient to impress any one with the full meaning of the word 'War.'

"We have very comfortable quarters located about 3 miles from the nearest trolley station.

"The telephone exchange recently completed here consists of a switchboard of 25 positions of which 15 are long distance."

Douglas Broadhurst, who was the News correspondent at the New York house until the draft carried him off to Camp Dix at Wrightstown, N. J., has won his first step and is now a corporal. A photograph of Corporal Broadhurst as a private appeared in last month's issue of the News.

Men from Hawthorne Service Department Take Up Service for Uncle Sam

"DINNY," remarked Jerry over at the Fire House, "do yez suppose ut's possible Uncle Sam is goin' to be a littul too gin'rous wit the inimy in this war?"

"Divvul a bit, Jerry, me lad," replied Dinny, "Uncle Sam is gin'rous, all roight, but he's nobuddy's fool. What guv yez the notion?"

"Will, Oi wuz jist cogitatin' after raidin' this card from Pete Sweers, him that wuz assistant to the hid gardener here at Hawthorne. Pete wroites that he's on his way to France, an' Oi wuz afraid maybe that Uncle Sam was intendin' to throw bouquets at the Kaiser, him sindin' over a foine gardiner loike that."

"No, no, Jerry," explained Dinny, "Ut's not that, ut's only that the b'ys are goin' to go through Germiny so fast that ut's goin' to kape an expert wit the spade good an' busy diggin' tranches fast enuff to accommodate thim."

With that explanation the News presents a picture of Mr. Sweers in his over-seas uniform, along with pictures of two other men called to the colors from the Hawthorne service department.

Sergt. Andrew Nitz, of Company C, 43rd Infantry, is a regular army man, who has been serving on the Hawthorne Police, subject to recall to the army as a reservist. He first enlisted in March, 1904, and saw service in the Philippines in helping to quell some minor disturbances among the natives. He visited Tien Tsin, China; Nagasaki, Japan; and Honolulu, Hawaii, during his first term of enlistment. In March, 1907, he re-enlisted for recruiting service. Three years later he again re-enlisted and was sent to Panama. The latter part of 1915, he returned to the United States and entered the Hawthorne Police Department. Sergeant Nitz belongs to the regular army and expects to see service soon.

The third picture shows R. E. B. Randall, another of Hawthorne's policeman who has seen previous army service. He is now Battalion Sergeant Major in the 311th Field Artillery at Camp Meade, Maryland.

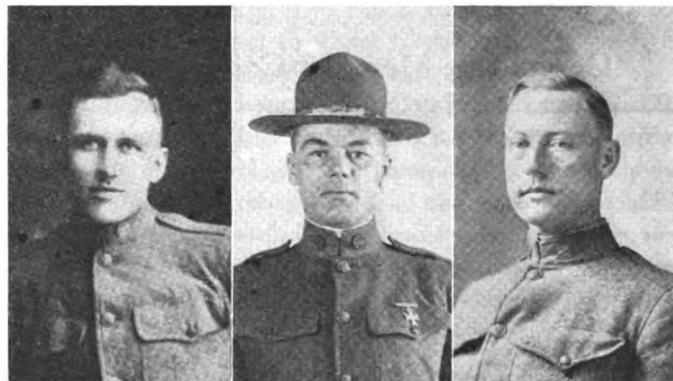

Three Hawthorne Men Who Are With the Colors. They Are (from left to right): Peter Sweers, formerly a gardener, who is now in France; Sergeant Andrew Nitz, a Hawthorne Policeman, Who Has Gone Back to the Army in Which He Served for Several Years; Robert E. B. Randall. Also a Hawthorne Policeman and U. S. Reservist

One of Hawthorne's New Lieutenants Receives the Double Cross After Conspicuous Gallantry

J. C. Hanley Wins a Commission and a Wife, But Loses Faith in His Friends

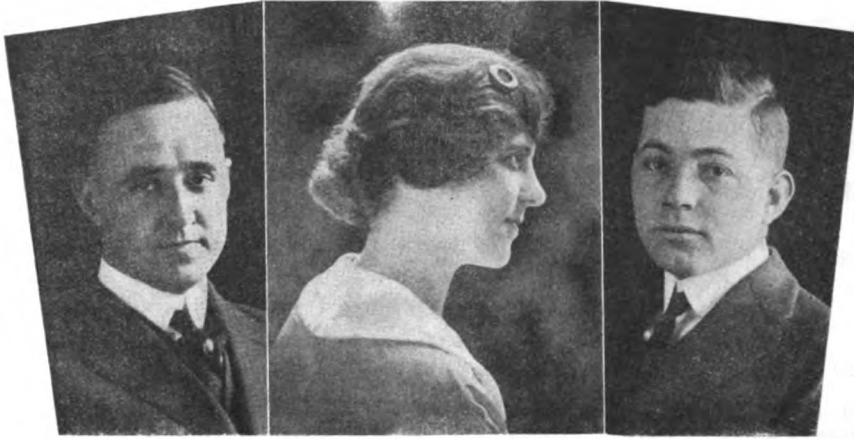

The Groom

The Bride

The "Best" Man

WHEN you pick out a best man for your next wedding, do not choose H. L. ("Jimmy") Ward, of the Hawthorne chemical methods department. Oh, of course, it would probably be all right, because "Jimmy" says none of this is true; but *you* know. Safety first! Anyway, here is the story:

A few months ago, J. C. Hanley, engineer of manufacturing methods in the C., R. & I. Shops, decided that he wanted to do his bit against the Kaiser at close range. Accordingly, he went to the officers' training camp at Fort Sheridan and got a commission. Then, while the getting was good, he returned to Chicago and got a wife. The commission was First Lieutenant of Ordnance; the wife was Miss Harriet Paul, 8522 Jackson Boulevard. And, to introduce the villain, the "best man" was H. L. Ward.

Here is what the *Chicago Tribune* of November 30th had to say about the affair:

Hawthorne Men Get Commissions

Three men from Hawthorne entered the second officers' training camp at Fort Sheridan and all three obtained commissions. They were: J. C. Hanley, department 7482, who was made a first lieutenant of ordnance; George Webb, department 6423, also commissioned first lieutenant of ordnance, and J. G. Cureton, department 6607, who got a second lieutenantcy in the signal corps.

Lieut. Full Transferred

Lieut. H. P. Full came in from Camp Gordon recently and shook hands with everyone around the Atlanta office, bidding them all good-bye, as he had just received orders to report at Garden City, Long Island.

Bride Kidnapped by Best Man as Tactics Lesson

"KEEP WATCH OVER COMMAND," HE TELLS WARRIOR HUSBAND

Yesterday was the wedding day of Lieut. J. C. Hanley, commissioned an ordnance officer at the last Fort Sheridan training camp. He and Miss Harriet Paul, of 8522 West Jackson Boulevard, were married in the morning at Our Lady of Sorrows Church.

Last night at 8:30 they departed for a fifteen-day honeymoon trip through the East. In the interim many exciting things happened, not the least of which was the kidnapping of the bride by the best man, an exciting taxi race, and a neglected wedding cake.

Bride Is Missing

Of course the kidnapping episode was all a joke. Mrs. S. C. Wagner, a sister, said when the excitement had subsided, but the bridegroom was slow in seeing the point. Here's how it all happened:

Many friends called at the Wagner home during the afternoon to bid the newlyweds godspeed. A wedding supper was to be served before train time. As the guests were assembling to enter the dining room noses were counted and two of the company were found missing—Mrs. Hanley and James Ward, of 146 Hamlin Avenue, the best man.

"I know where they have gone," vouchsafed Miss Berdena Faulkner, the maid of honor. "We were to meet at the Chicago Athletic Association rooms before going to the train. I'll bet they are there."

Lesson in Tactics

The bridegroom, a trifle pale, but with soldierly restraint, took charge of the situation. A motor car was commandeered and the chauffeur violated the speed ordinances.

Kidnapper and kidnappee were found at the journey's end. Best Man Ward indulged in a broad smile. It was faintly reflected in the relieved face of Lieut. Hanley.

"This is a little lesson in military tactics," the former said. "An officer should watch over his command."

Now Ward denies the story absolutely and *in toto*. But still he has not filed any suit for libel against the *Tribune*. Doggone it all! A person doesn't know what to believe these days.

Well, anyway, there's a tip for you. Safety first!

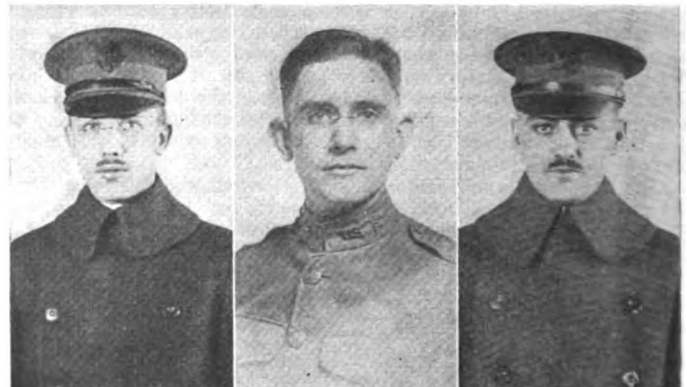

A Trio of Hawthorne Physicians Who Are Officers in the Medical Reserve Corps. They are (from left to right) Lieut. F. W. Trowbridge, Lieut. F. L. Alloway and Lieut. C. P. Harris

The Christmas Funds for the Soldiers

CHRISTMAS boxes for the Western Electric men in military service were sent out last month by employees of the Company in all parts of the country. Not all of the branch houses have reported to the News, evidently preferring not to mention their own good deeds, but from letters written by soldiers and

in another column. In New York the employees at 195 Broadway and West Street combined forces and raised the sum of \$1,500, considerably more than they expected when they began their campaign which lasted for only a day or two. With this money they sent out 355 packages, each of which contained the following articles: Money-belt, five small packages of smoking tobacco, one package of cigarette papers, one rubber cap for smoking tobacco packages, one package of playing cards, four packages of chewing gum, one cloth bound diary, Christmas card.

DO YOU EXPECT TO HAVE



HOW ABOUT THE BOYS OVER THERE ?

"THE CHRISTMAS COMMITTEE"

The Cartoon That Got the Cash. Drawn by George J. Nelson, of the Drafting Department at West Street

from other sources, the News has learned about some of the funds which were raised.

The work of the Hawthorne employees is described

Among the branch houses which have been heard from are Cleveland, St. Louis, Los Angeles and Cincinnati. The St. Louis employees, long before Christmas, remembered their fellow employees in the service in a way that might well be adopted by other houses. A special newspaper fund was raised and, as a result, all the St. Louis employees in the Army and Navy have been receiving their favorite St. Louis newspapers daily, or as often as the irregular mail service will permit.

A copy of the letter which was sent out with every package from the Cincinnati house has been received by the News and is printed as an example of the Christmas spirit which prompted the raising of funds for the soldiers.

Dear Fellow-worker:

Although you are not in our midst daily as in the past, we, all the employees of the Cincinnati Branch of the Western Electric Company, want you to feel that we appreciate what you are doing for the Company and for us and ours, and we often think of you and miss you from your accustomed places.

With the approval of the Manager and the House Committee we have made up a collection and are sending to all of our boys a small Christmas package. The material worth of this package is not great. It is only a token of the place you hold in the hearts and minds of all of us, especially at this Christmas time.

We send you our best wishes for a Merry Christmas and A Happy New Year, and hope that when Christmas 1918 rolls around you will be back with us again in your respective places.

The Soldiers' and Sailors' Comfort Club of the Hawthorne Works

THE men and women of the Hawthorne Works have formed a club known as the "Soldiers' and Sailors' Comfort Club," whose purpose is to look after the boys who have left the Works for the service, to supply them with the extra comforts that Uncle Sam does not furnish, and to cover a field of welfare work that the Welfare Department of the Company cannot touch. These activities will take whatever form occasion may demand. The principal ones planned at present are as follows:

- (1) Collect and distribute reading matter.
- (2) Keep in touch by correspondence with each man.
- (3) Provide a regular tobacco fund.
- (4) Furnish knitted or sewed articles as there may be a call for them.
- (5) Provide a means of putting the employees in touch with the special needs of individuals in the service.

The membership of the club already is 15,000. When the canvass is completed it will be much in excess of this figure. Everyone on the Hawthorne pay roll is eligible for membership. The dues are ten cents per month. A

special button is worn by members to show that they are doing their bit.

The club already is in touch with 1,000 of the Hawthorne enlisted men to whom Christmas boxes were sent. These boxes contained principally good things to eat and good things to smoke, besides loads of good wishes from the hearts of all Hawthorne people.

Later the Comfort Club hopes to locate every Hawthorne man in the service and to do a little to make things more pleasant for every one of them.

Repair Shop Sends Tobacco

About two hundred men in the Clinton Street repair shop have formed a club to supply former shop men, now in the service, with tobacco. The club began by sending packages to Camp Grant. Each package consisted of 3 boxes cigarettes, 1 box cigars, 1 box smoking tobacco, 12 boxes matches, 1 pipe and 1 package pipe cleaners.



To Be Awarded in January

THIRTY-FIVE YEARS		Thomas, A., Hawthorne, 6965.....	"	10
Desmond, W. J., Hawthorne, 6338.....	January 17	Peterson, H. P., Hawthorne, 6301.....	"	12
THIRTY YEARS		Reed, F. M., Hawthorne, 6136.....	"	15
Lancaster, C. J., Hawthorne, 6339.....	January 2	Johnson, Anna M., Hawthorne, 7682.....	"	21
TWENTY-FIVE YEARS		Arnhorst, C. F. W., Hawthorne, 7394.....	"	26
Huening, H. A., Hawthorne, 6434.....	January —	Zimney, Katie, Hawthorne, 6338.....	"	26
Sleeman, J., Hawthorne, 6839.....	" 18	Hart, M., Hawthorne, 6756.....	"	28
TWENTY YEARS		Silhanek, J., Hawthorne, 6161.....	"	28
Kuhn, C., Hawthorne, 6338.....	January 3	Anderson, J., Hawthorne, 6336.....	"	29
Dell, H., Hawthorne, 9358.....	" 12	Coffey, J. H., Philadelphia.....	"	15
FIFTEEN YEARS		TEN YEARS		
Rebell, F. C., Denver.....	January 1	Flowers, W. E., Atlanta.....	January 1	1
Taylor, E. U., Denver.....	" 1	Williamson, Emmie I., Atlanta.....	"	30
White, A. N., Denver.....	" 1	Kruegal, A. R., Dallas.....	"	1
Lassial, A. N., Hawthorne, 5754.....	" 5	Newmiller, Mrs. Lola, Dallas.....	"	1
Framke, E., Hawthorne, 6325.....	" 6	Reynolds, W. M., Dallas.....	"	1
Blacker, H., Hawthorne, 9505.....	" 7	Frank, C. W., Dallas.....	"	20
Christensen, Annie, Hawthorne, 7898.....	" 7	Kelly, S. R., Dallas.....	"	20
		Moench, W., Hawthorne, 5915.....	"	16
		Feeney, J. T., New York.....	"	16
		Palmer, J. C. R., New York.....	"	18
		Reese, A., San Francisco.....	"	21

Who They Are

W. J. Desmond



There are three kinds of machinists—garage repair men, ordinary machinists and tool-makers. A tool-maker is a sort of machinist de luxe, while a garage man is a machinist de— well, just the “d” and a dash describe him quite definitely.

W. J. Desmond qualifies in the de luxe class. He is a punch and die maker in the punch press department, and can make a punch and die work after everyone else has given it up as a bad job. Bill isn't going to let any tool talk back to him after all these years.

He went to work for the Western away back in 1883. Despite his long service, he is not an old man yet, by any means. A man is as old as he feels, and Bill can still show the youngsters a few tricks when he goes out with the boys.

C. J. Lancaster



Every once in a while Chicago has a chicken show. Perhaps to avoid misunderstanding, we should say a poultry show. When that is on there is no use going to visit Charley Lancaster, because he won't be at home. Mr. Lancaster's big hobby is chickens. And they are not only hobby chickens, but nobby chickens that take prizes. He also raises stars for his

service button, to which a new one will be attached this month, making a total of four.

Mr. Lancaster was a punch and die maker in the early days, and a good one, but he also proved to have good executive capacity, so he was taken from the tool-making work of the punch press department and put into the executive end. He is now foreman of 6339. Mr. Lancaster has two sons in the country's service, one in the navy and the other in the army.

H. A. Huening



In 1893 Herman A. Huening got a job in the power apparatus stock rooms at Clinton Street. That, and the fact he is still with the Company, will give you a chance to try out your arithmetic and see if the service awards people are correct in giving him a three-star button this month.

From the stock room Mr. Huening went into the piece-work rates department until the end of 1909, when power apparatus manufacturing was discontinued by the Company. He is now in charge of the checking group of the layouts department. Mr. Huening's principal recreations are chess and music. He is a violinist of considerable ability, although of late years he has given up playing in public and plays only for his own enjoyment.

As for the chess, sometimes he plays for his own enjoyment and at other times for the other fellow's.

J. Sleeman



When Joe Sleeman came to Hawthorne with the punch and press department of the New York shops, old High Cost of Living got up, brushed his clothes and prepared for another try. Up to that time he knew he was licked. Joe used to go out on the ocean fishing every Saturday and Sunday, and when he got home the neighbors came over with wheel-barrows to haul away their share of his catch. After that they could laugh at the butcher again for a week, and after a week Joe went fishing again, and after that they could laugh again and so on and so on forever and ev—. No, because just then Joe was transferred to Hawthorne. He doesn't do much fishing now, because Lake Michigan is too small to hold fish enough to keep a real fisherman busy.

Mr. Sleeman has seen 25 years of service in punch-press work and has risen to the position of group foreman of the heavy punch-press department.

C. Kuhn



This ought to be a special punch-press edition of the Service Awards page, since that department is furnishing four of the six men receiving service buttons this month for 20 years or more of continuous employment with the Company. Charley Kuhn is the two-star representative. He started in the department at New York in 1898. Mr. Kuhn came to Hawthorne in 1909, when his department was moved from New York. He was a sub-foreman in the department until the rush of work made a night force necessary, when he was appointed night foreman.

Charley is considerable of a bowler and can always be counted on to hold down his end when the boys in the department get a couple of teams together and go out after each other's scalps.

Louis Fiille



Louis Fiille is one of the Company's wanderers who do their work so well that they get sent from one house to another to show the others what a real good man looks like. He began being a Western Electric man in Chicago in 1897 and has been one ever since, although in the meantime he has been compelled to sojourn for considerable periods in such places as Indianapolis and Detroit to mention only a few of his stops. While he was in Indianapolis he captured the bowling championship of that city so his residence there was not without its compensations.

Since 1913 he has been a member of the Accounting Department in New York and seems to like it as much as his fellow-workers like him, which is a good deal according to all reports.

H. Dell



Did you ever look at the back of a switchboard and wonder how it was ever possible to make that curled centipede with the feet that end in a fringe of wires, every one of which must reach the exact spot it is intended for? Well, it's very easy after you understand it, just astronomy or higher mathematics or advanced physics or any of those simple subjects. If you care to study it up Harry Dell would make a good instructor for you. He has charge of the group that draws up cable layouts in the switchboard wiring department, and he can make a wire twist around more than a woman looking into a mirror to see how her dress fits in the back.

Mr. Dell started with the Company twenty years ago as a shop clerk at Clinton Street. Later, when the output department was first organized, he took up work there until he was transferred to the factory cabling job in 1903. From there he went into the switchboard wiring department in 1904. He has been connected with this department in various capacities ever since.

O. Muller, Sr.



O. Muller, Sr., received his twenty-five year button last month, but his photograph was not received in time for insertion in the December issue of the News. Ever since he began work with the Company in 1892, Mr. Muller has stuck to the model shop in New York and he is one of the best instrument makers in the establishment. There isn't a youngster in the shop with eyes sharp or keen enough to do better work than he does.

One of his greatest admirers is Vice-President Albright, who, whenever he has a knife to be repaired or wants some other little job of like character done, isn't happy unless he can get Mr. Muller to do it. It is even rumored that Mr. Albright made one trip to New York for the one and only purpose of getting Mr. Muller to do a bit of repair work for him, although, of course, the reason assigned for the visit was "important Company business." Neither Mr. Albright nor Mr. Muller would affirm or deny this rumor so it will have to stand as it is.

The reason Mr. Muller is referred to as O. Muller, Sr., is because he liked the Western Electric Company so much that he got a job at West Street for his son when the latter was old enough to work, and both father and son are still on the job.

Frank J. Hyland

Frank J. Hyland, who added a third star to his service button last month, has been a familiar figure in the New York house for many years. He came with the Company in December, 1892, and worked in the clerical department for seven years. Since then he has been in the export department.

A Few Fifteen Year Men



J. H. Coffey



A. Thomas



F. C. Rebell



F. M. Reed



C. F. W. Arnhorst



A. N. Lassial



A. N. White



E. A. Framke



J. Sülhanek



H. Blacker



Charles F. Nickel Dies

Charles Friedick Nickel, a former employee of the Company, died at his home, 600 West 116th Street, New York City, on December 18. He was in his seventieth year and for the last nine years was on the Company's pension list. Mr. Nickel first began to work for the Western Electric Company in 1880 and retired in 1908, after twenty-eight years and three months of service. At the time of his retirement he was a foreman in the New York shop.

The funeral services were held at Mr. Nickel's residence on the afternoon of Saturday, December 15. A number of his former fellow employees in the New York shop were present. Mr. Nickel was unmarried.

Changes in Organization

Earl M. Clark has been appointed to the position of European Auditor to succeed E. Cuthbert Platt, Jr., who was killed recently while fighting on the French front as an officer in the Canadian Expeditionary Force. Mr. Clark was first employed by the Company as a member of the claims department in Chicago in August, 1907. After about a year in Chicago he was transferred to the Treasurer's office in New York. Later on he worked in the Comptroller's office, and in October, 1911, was made auditor-accountant in Antwerp. A little less than a year later he was transferred to a similar post in London and occupied that position until his recent appointment to succeed Lieutenant Platt.



Chicago's Service Flag. A Home-Made Product and the Girls Who Made It

After sticking closely to the Pacific Coast since he entered the employ of the Company in 1905, George A. Schneider is going to try a taste of Eastern life; that is, he is going to get as far East as Buffalo where he will succeed J. W. Tabb as manager. The sales department at San Francisco has been the scene of Mr. Schneider's labors ever since he came with the Company. He got as far away as Los Angeles in 1907, however, but before his friends in San Francisco had ceased to miss him he was back again.

George Siess has been made assistant manager of the Cleveland house. Mr. Siess came to the Company in 1914. He has been stores manager of the Cleveland house for the last three years.

AFTER THE WHISTLE BLOWS



Atlanta Salesman Wins Another Golf Cup

Our city salesman, J. W. Smith, of 31 Luckie Street, has again made good in golf, having won the chief cup during the recent tournament of the Atlanta Telephone & Telegraph Society. This is the second cup Jimmie has won in these tournaments, as he also was victorious last year.

As you will recall, his home and its contents were destroyed in the big fire of May 20, which wiped out such a large section of Atlanta's residential district, and among the treasures which he lost was the cup which he had won at the first tournament.

I was talking to him just a few days ago about winning this second cup, and Jimmie made this statement: "Now, of course I don't like to win all these cups, but inasmuch as I have been telling all of my friends that I had a cup and was afraid some one would drop in on me and ask some day to see it, I thought I had better go out this year and win this cup so as to be able to show one and not have to explain that the original cup I won was lost in the fire."

You can see that Jimmie is very considerate of his opponents' feelings and only won this cup just simply because he had to.

W. E. L., Atlanta.

The President Speaks

Chicago's modest little violet, George Porter, who has just been elected president of the Illinois Athletic Club, writes to one of his friends in the General Sales Department: "If you have any political aspirations of any kind covering anything from President of the United States down, we are holding intact the organization that put over the Members' ticket at the Illinois Athletic Club, and for a little financial consideration we will be glad to put over for you anything you want."

Attention of F. De C. Thompson

[The poem which follows was written by an employee who for some reason does not wish to disclose (her?) identity. The person to whom the poem is dedicated is F. DeC. Thompson of West Street. A diligent investigation has failed to reveal any indication that Mr. Thompson is contemplating departure, and after he reads the poem he surely will remain.]

Mr. Thompson, we adore thee,
Never leave us, we implore thee.
You are so wise, so good and true,
No one could take the place of you.
Without you we should surely fall,
We'd stumble off and lose the trail.
You're always ready to lend a hand,
Yet command respect and are simply grand.
At elegant poetry we rival Shakespeare,
These lines are bad but the sentiment's here.
It could all be told in a word or two—
Mr. Thompson, we pledge allegiance to you.

One of West Street's Many Service Flags

The Accounting Division of the Engineering Department at New York has hung up a service flag of its own and is keeping in touch with its former members who have joined the various branches of the service. In the photograph at the right the service flag is shown hanging beside the Stars and Stripes.

It was at a Hallowe'en party that the two flags were first hung up and at that time there were only 11 stars on it. Since then two have been added.

Under a big piece of plate glass on one of the desks, a photograph collection of the boys in service is being started, and H. W. Barrows, who has the matter in charge, hopes soon to have his set complete.

The 18 members of the division who have gone to war are: M. A. Carlsen, J. E. Evers, R. C. Fisher, H. C. Hoffman, R. C. Ketcham, D. Kerr, H. R. Lake, T. P. Lawless, H. M. Mower, G. B. Small, V. Wille, Jr., W. Moreau and H. J. Sveka.

Those in the picture on the right are, from left to right (standing), J. F. Misceli, L. Brown, W. J. Cuddv. A. Cameron, G. D. King, W. J. White, E. A. Bretz; (seated), O. L. Mabey, Miss Irene Fisher, H. W. Barrows, P. R. Goodwin and R. W. Luster.

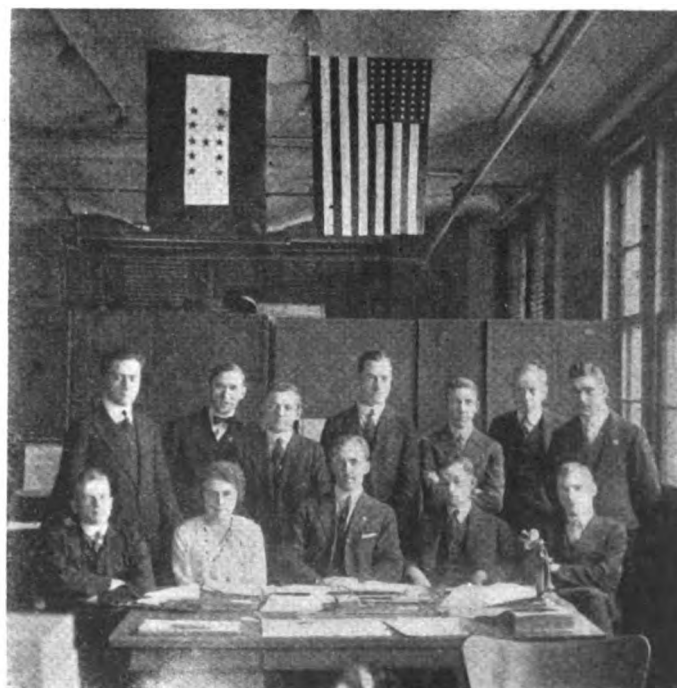



The Assembly Departments Assemble

Banquet and Dance of the Hawthorne Assembly Departments

There are only two ways to report a banquet. One is to invite everybody and let them make their own report. The other is to print a picture of the banqueters and add: "A jolly good time was had by all." Nothing else you can say means anything to anyone who wasn't there.

New York Engineers' Club Enjoys Itself

The members of the Western Electric Engineers' Club of New York, which was organized a little more than a year ago, held an entertainment and dance on the evening of December 19th, at the Palm Garden on 58th Street. The illustration shows the ticket of admission which was patterned after the passes which every employee has to produce these days before entering the West Street building.

From start to finish the entertainment was provided by Western Electric employees, all from West Street with one notable exception, Miss Emily Halley, whose rhythmic dancing was received with wild applause. She is in the voucher department at 195 Broadway.

"High Voltages," described in the program as "A Current Event of Varying Frequencies in 1 Watt; music by Jove, and lyrics by Heck," was the main event of the evening. The characters all possessed beautifully

alliterated names such as Lotta Lunch, Silva Servus, Carrie Circuit, Regina Receiver, Pearlie Payroll, Rita Resistance, Anna Ampere and Beatrice Battery.

In charge of the proceedings was G. B. Hamm, and he also had the hardihood to appear on the stage, thus exposing himself for the rest of the evening to the inevitable joke about a "ham actor."

The Grand March at midnight closed with the singing of the "Star Spangled Banner." That didn't end the dance, however, and the phrase on the ticket about "Overtime Wednesday Night" became more and more appropriate as the hours went by.

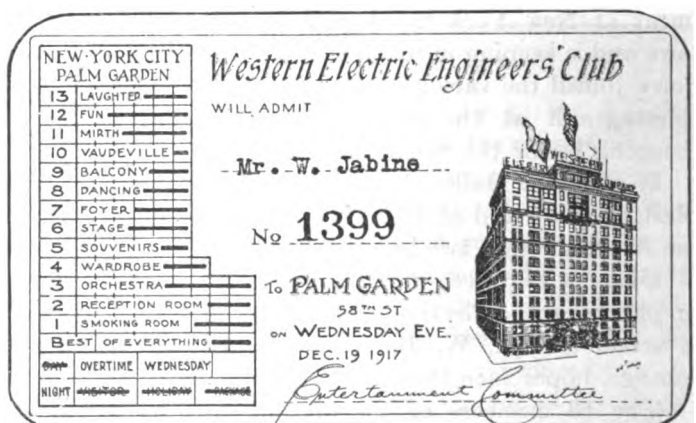

The Badge That Let the News Get Past the Doorman

Western Electric Company

H. B. Thayer, President; H. A. Halligan, Vice-President; W. P. Sidley, Vice-President and General Counsel; A. L. Salt, Vice-President and General Purchasing Agent; Gerard Swope, Vice-President and General Sales Manager; H. F. Albright, Vice-President and General Superintendent; J. W. Johnston, Treasurer; F. B. Jewett, Chief Engineer; G. C. Pratt, Secretary; R. H. Gregory, Comptroller; C. E. Scribner, Consulting Engineer

Office of publication and address of President, Secretary, and Treasurer, 195 Broadway, New York City

Western Electric News

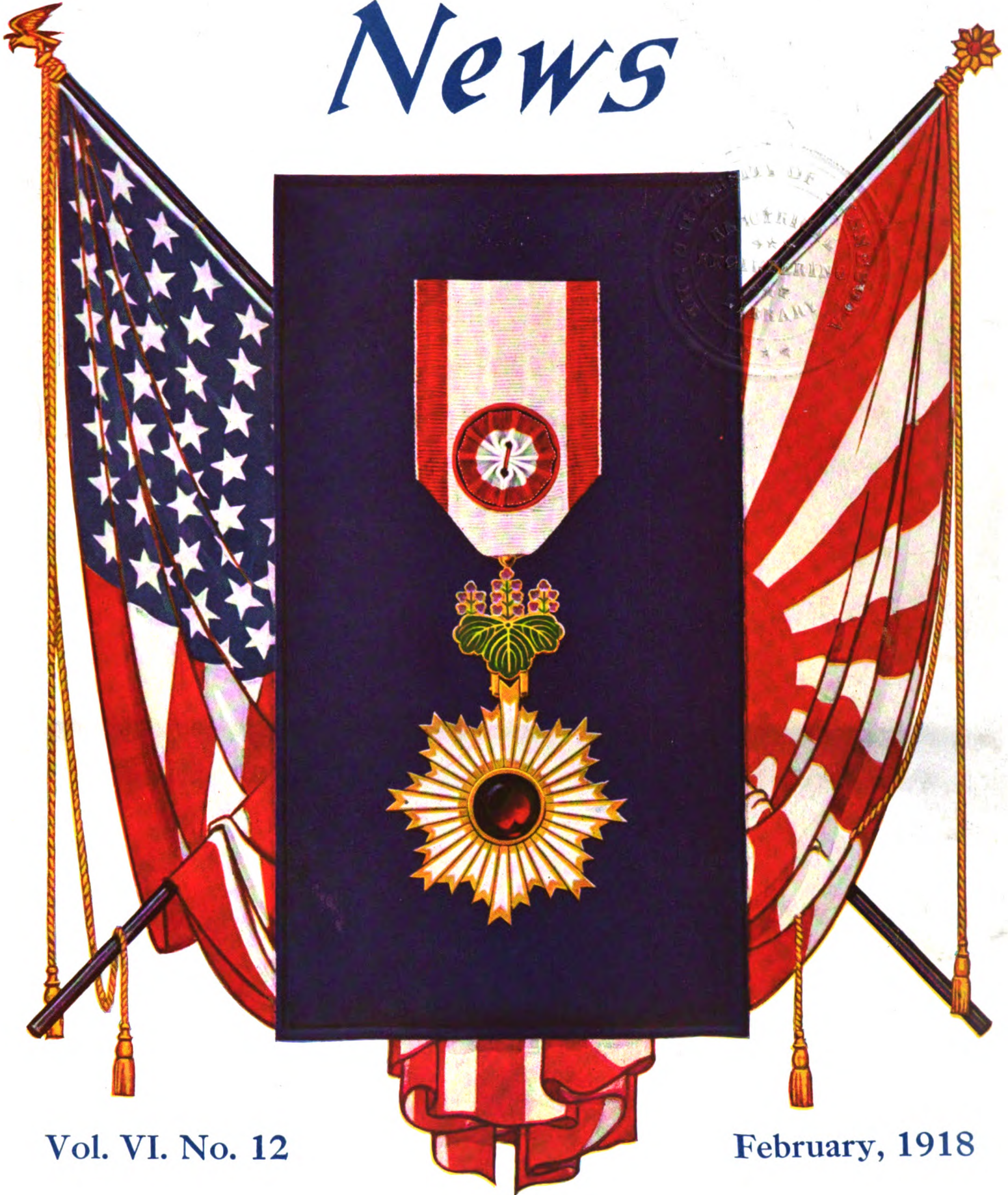

Vol. VI. No. 12

February, 1918

FOURTH ORDER OF MERIT OF THE RISING SUN
Decoration conferred by his Majesty, the Emperor of Japan, upon Gerard Swope, Vice-President of the Western Electric Company

Electrical Merchandising

McGraw-Hill Company, Inc.



*These are Your Customers and Ours
Ours — through You!*

The WESTERN ELECTRIC policy is to sell through the dealer
to create new customers for the dealer customers that are

Ours — through You!

Western Electric Company
INCORPORATED

Offices in all Principal Cities

Western Electric News



BOARD OF EDITORS

Editor in Chief, P. L. Thomson
Associate Editors: W. F. Hendry, W. E. Leigh, S. W. Murkland, E. C. Estep, H. D. Agnew, S. S. Holmes, F. W. Willard, M. A. Curran
Assistant Editors: William Jabine and Reed Calvin

Subscription: \$1.50 per year, except to employees of the Western Electric Company, to whom copies are furnished free of charge. All communications and contributions should be addressed to WESTERN ELECTRIC NEWS, 195 BROADWAY, NEW YORK. Matter intended for any given issue must reach New York not later than the 12th of the preceding month.

VOLUME VI

FEBRUARY, 1918

NUMBER 12

My First Visit To Japan

By Gerard Swope

ON BOARD THE *EMPRESS OF ASIA*, DECEMBER 7, 1917



S EVEN months have passed since I left my associates in the Western Electric Company, and so much has occurred in this time that it is difficult to single out, for a short article, those things which would be of greatest interest to readers of the NEWS:

Even this week has been very interesting, for although the route of this ship is far north, just south of the Aleutian Islands, still the weather has been mild and pleasant. Most of the days have been clear and full of sunshine, and on the whole the seas have been smooth. But furthermore, the week has been interesting by reason of the fact that it has consisted of eight days, an unusual experience in my life. The day after Wednesday, December 5, was not, according to our usual experience, Thursday, December 6, but was Meridian Day, without a date, and the day following was Thursday,

December 6. It is hard to realize that we have had a whole day extra, but that only makes up for the day we lost on our trip to the Far East. However, a day lost is not the unusual and interesting experience that an entire day gained is. Before Meridian Day, when it was Wednesday with us, it was only Tuesday night at home, while after it, we are living in the same day as our friends at home, and it begins to make our homecoming seem more real.



Gerard Swope, Vice President and General Sales Manager

Of course, the first and greatest impression that Japan makes upon one from the United States, and particularly upon one who is interested in commerce and industry, is its very rapid development. Not only has it been rapid, but intensive. Japan is a small country, with comparatively a very large population—about the size of Illinois, Indiana and Iowa, with a population more than five times as many as in those three States. Furthermore, only a small part of the land can be used productively because of the many mountains. The arable



This Photograph Shows a Chair Carried by Two Coolies On One of the Roads Near Hakone. The Figure in the Background, Walking, is That of Mr. Swope

land is intensively cultivated, and in no country have I seen human beings work harder and longer than in Japan. The natural resources are not great, but notwithstanding, Japan has and is developing its industries remarkably. It seems unbelievable that less than fifty years ago Japan was still in the Feudal Age, and that in this short time it has completely changed and come into the first rank of nations commercially and industrially.

Before 1868 Japan had been an absolute monarchy, with the Emperor a symbol only, the real power being in the hands of a powerful family, the head of which acted as Regent (Shogun), who always held before the people the idea that the source of his power was the Emperor. The organization of the upper classes was entirely a militaristic one, and all through the country the ideal of the submission of the individual to the over-lord was the chief and central characteristic. When, then, the country was opened to Western influences, the change took the form, not of rebellion to the Emperor, but of rebellion to the Regent, and the restoration to the Emperor of his full powers, without any intermediary.

Japan was most fortunate at that time in having able men, both in the persons of the Emperor and his advisers. They were broad-minded and masterful in the policy



Women Gathering Tea in the Fields Between Kyoto and Nara

they adopted, and during the ensuing years Japan consistently followed the course laid down by them.

The kind of government that Japan has is much easier for us to understand if we remember that it is the development of the old ideals of Japan, where the ideal of the Emperor or the State is uppermost, and the duty of the individual to the Emperor or the State is all-embracing and clearly understood and accepted by all. In the legends of Japan and their dramas this characteristic is constantly seen. It is still taught in the schools, and is followed with the greatest interest and absorption by the people. It leads to a high ideal of public service, where it is considered a great honor to serve the State, and where service to the State is given willingly and conscientiously. This is seen not only in war, as it was so dramatically at Port Arthur, but also in civil life, where the best men serve the Emperor gladly and loyally.

There is an old saying, by one of the early Emperors, which seems to me significant—"The well-being of the people is the well-being of ourselves," and Ieyasu, the first Tokugawa Shogun, said: "To assist the people is to give peace to the Empire—the people are the foundation of the Empire."

The question often occurred to me—Has the well-being of the people in Japan increased by the adoption of Occidental civilization over what it was prior to 1868? After observation for some months, and after talking to many people, my own conclusion is that it has. Today there is greater security of life; there is a greater variety of food, shelter is assured, and both are provided with greater certainty and less exertion; and the liberty of the individual among the common people is greater. In addition, primary education is provided by the State and made compulsory for all. The people, especially the children, are clean, healthy, happy and contented. They are orderly and law-abiding, and there are few cities in the United States with so few police in proportion to the population as Tokyo or other cities of Japan. The people are kindly, especially to the foreigners. Even in small towns and in the country one is greeted by a smile and a cheery word by children and elders.

What is so interesting to me is the fact that in Japan we have a nation of upwards of sixty millions of people, who have, within the lifetime of men still living, adopted an entirely new civilization, a change the like of which has, as far as I know, never before been made on such a scale in the history of mankind. From having no foreign intercourse, they now have alliances with foreign nations, intimate intercourse, and their foreign commerce is large. From having but small hand industries, they now have large industries, using machinery to a great extent, and also manufacturing it.

Although you may expect from me figures and statistics, I am not going to give any, but simply will try to bring before you the salient impressions. If you are interested there are many books written about Japan and its rapid development which make interesting reading.

Another matter that surprised me was the absence of soldiers from the city streets, especially as I recalled the

early traditions of Japan and the successful wars that it has waged. Although Japan has a comparatively large standing army, even in these times, its streets are freer from soldiers than the streets of London or of Paris before the war.

I was one of the three unofficial Americans who were fortunate enough to be present in June at the opening of the Diet by the Emperor. The floor of the House of Peers was filled by the members of both Houses of the Diet, standing, all in their appropriate uniforms and decorations. The galleries were filled with the diplomatic representatives of the foreign governments, also resplendent in their uniforms and decorations. The cabinet was present, headed by Marshal Count Terauchi.

On the entrance of the Emperor and during the reading of his message, and indeed until his departure, the silence and reverential attitude of the entire assemblage were most marked. It was indeed a most impressive and illuminating ceremony.

I saw the Emperor again on the occasion of the military review, on his birthday. He was driven through the streets in his carriage, with the Imperial body-guard following, and the attitude of the people was clearly one of great reverence. At the review he first rode around the large field followed by his staff, and afterwards the soldiers—infantry, artillery and cavalry—marched by the reviewing stand, which gave me a good opportunity to see thousands of Japan's sturdy soldiers at close range.

At the Chrysanthemum Party in November, given at one of the palaces in Tokyo, I again saw the Emperor. On this occasion he and the Empress, accompanied only by civil officers and servants of the Imperial household, made a tour of the garden, while their two thousand guests stood grouped on one of the lawns and bowed low as he passed.

Early in the seventies the Government sent out men to study the political and judicial, the civil and military systems of different countries. It sent out young men to be educated in European and American schools, in order to bring home the results of their study and observation.

In 1890 the Japanese Government sent a commission to investigate telephone systems in Europe and America, of which Dr. Satori Oi was the head. Dr. Oi was then the Chief Engineer of the Ministry of Communications. Of all the men whom I met, I know of none whose intellect and character I more respect and admire than that of Dr. Oi. On Dr. Oi's return, as a result of and in line with his report to the Ministry, the telephone development began.

In Japan the Ministry of Communications (Teishin-sho), of which His Excellency, Baron Den is the present head, supervises all means of communication of the Empire. This includes the post office, and even postal savings banks, the railroads, water transportation, telephone and telegraph, wire and wireless.

The telephone system in Japan consists of approximately 250,000 subscribers and toll lines, connecting the principal cities. Unfortunately, because of the great need



In Mr. Iwadare's Garden at Odawara, His Country Home on the Southern Sea-coast of Japan. Those in the Picture Are Mrs. Iwadare, Mr. Swope and Mr. Iwadare

and pressure in other directions, as much money has not been spent in the development of the telephone as Japan's own people and the heads of the Ministry of Communications would have liked. As is often the case with each of us in our own lives, and of course, even more so with large corporations and with governments, many things that we should like to do or see done must either be done in part or postponed because of greater necessity and pressure in other directions. There are in Japan upwards of 200,000 people who have paid 15 yen (\$7.50) and made application for a telephone, and no doubt thousands of others desire the telephone but have not made application because of the discouragement of so long a waiting list. The possession of a telephone in Japan is a valuable asset, and is considered as such on the books of many companies. Telephones are not given up but are transferred and sold by one subscriber to another for sometimes as much as 1,000 Yen (\$500).

But the great thing is that Japan recognizes the aid to commerce, industry and civilization that the telephone is, and this last summer the Diet passed a bill approving the expenditure of 100,000,000 Yen (\$50,000,000) over the next eight years in the development of the telephone facilities of the Empire. This will go far towards meeting the need, but with Japan's rapid development in



A Fourteenth Century Play Given at the Imperial Theatre in Tokyo by the Leading Japanese Actors, All of Whom Are Men. Those in the Picture Are (from left to right): Sojuro, Baiko, Sonosuke and Uzaemon

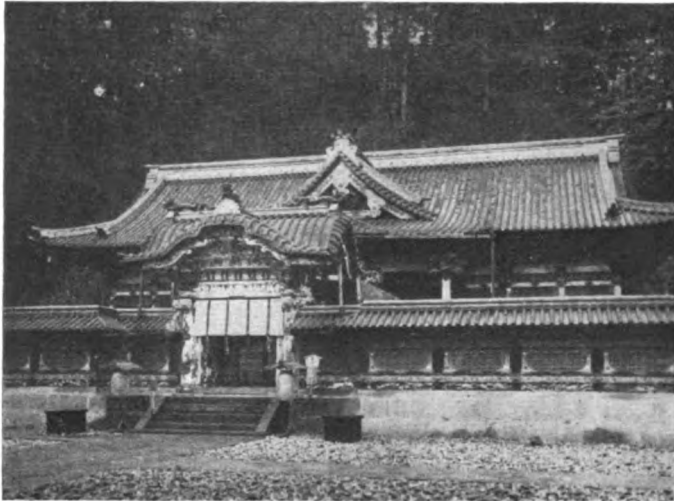

Karamon—the Entrance to One of the Many Beautiful Temples in Nikko. The Picture Shows Clearly the Dense Foliage in the Background

industry and commerce it is confidently expected that before this period has elapsed an even greater sum for telephone extension will be needed.

The successors of Dr. Oi as Chief Engineer of the Ministry of Communications have been men of distinction—Dr. Asano, Professor of the Imperial University in Tokyo; Dr. Igarashi, and now, Mr. Urata, the present Chief Engineer. It was my good fortune to meet these gentlemen, and also their associates, many of whom have



Cryptomeria, 250 Years Old, Nikko. These Trees Were Given By a Lord Who Was Too Poor to Bring Anything Else to the Sacred Shrine

traveled and studied in America. They are all most appreciative of the opportunity that has been offered to them by the Western Electric Company and the Bell System in the United States, and the assistance we have at all times offered. The business of the Western Electric Company or Bell System is not solely commercial or industrial. We are connected with a service which is constantly tending to bring people closer together. Therefore, we are glad to put the results of our work at the disposal of those who would put these facilities in the service of an ever-increasing body of people.



Japanese Woman in Native Costume Cleaning the Road in Nikko

I hope, with the rapid progress of our work in the United States, an even larger number of Japanese and other foreigners will visit us, and, as in the past, it will be not only our duty but our pleasure to afford them every facility for taking advantage of the progress we have made.

The record of our own country in its relation with Japan has, on the whole, been good, dating from the visits of Commodore Perry and the first treaty made by Townsend Harris, which won the respect of the Japanese in later years because of its eminent fairness. In those early years a customs tariff was fixed by treaty between Japan and other Governments. Later, when Japan wished to have these treaties modified, the United States was willing to accede to Japan's desires, although some other nations were not. It was not until Japan had shown that it had so completely assimilated Western ideas, by its increasing strength and, later, by its victory over China in 1895, that modifications of the treaties between Japan and other nations were finally agreed to.

As all the readers of the News know, the Nippon Electric Company, Limited, is our associated company in Japan. The character of its business is much the same as our own. It manufactures telephone apparatus, switchboards and cable, and also distributes and imports electrical supplies. Traveling in Japan and Korea I often saw evidences of its activity in telephone apparatus and electrical supplies bearing its name, or our own specialties brought from the United States and bearing the familiar script letters of the Western Electric Company. It will interest you, as it did me, to think that some of the apparatus made in Hawthorne and some of the best electrical devices made in the United States may be found in service so far from their point of origin.



Mr. Swope and his guests at a dinner given by him in Tokyo. Among those in the picture are Dr. Oi, formerly Chief Engineer, Bureau of Post, Telephone and Telegraph of Japan; S. Urata, the present Chief Engineer; Dr. O. Asano, Professor of Electrical Engineering, Imperial University of Tokyo, and K. Iwadare, Managing Director of the Nippon Electric Co., Ltd.

The Nippon Electric Company was the first company in Japan representing co-operation between American and Japanese citizens. It has had over eighteen years of uninterrupted activity, has been growing and has been successful, and has now a force of approximately 1,000 people. It also has under way at the present time new buildings, which will double the capacity of its plant.

In all this time it has been under the management of Mr. Kunihiko Iwadare, who was the first manager of the business, and is still the managing director of the company. In America, in Europe or in Japan, a business man with higher ethical standards it would be hard to find.

There are few of us who would not agree on the broad principle of co-operation—the difficulty is always to find ways and means to co-operate. A concrete instance, such as this, is the best way to begin, and by the ever-broadening influence of more of such concrete instances of working together, the friendship of peoples will be more assured.

While in Japan I met all of the original shareholders

of the Nippon Electric Company, Limited, all of whom are still interested in the business, who have been satisfied with the results of the business, and who appreciate and value the relations their company has had with the Western Electric Company.

Before 1899 none of these shareholders had any actual experience in co-operation with foreigners. Now they have had eighteen years of successful dealings, and have satisfied not only themselves, but have told others with whom they come in contact, of how satisfactory this relationship has been.

We, on our part, can tell our friends in America how entirely satisfactory our co-operation with our Japanese associates has been. This much mooted question of co-operation between Japan and America is going to depend largely upon the results of more concrete instances such as this. It was constantly borne in upon me that a friendship or a good relation between individuals and peoples, to be continuous through a long period of years, must be founded on mutual respect, confidence and fair dealing.



Holland in War-Time

Some of O. F. Stein's Experiences at The Hague During the Last Three Years



O. F. Stein

UNFORTUNATELY, this article will have to begin with an apology. O. F. Stein, who spent the last couple of years at The Hague, can talk most interestingly of his experiences, but he can't tell the readers of THE NEWS about them. "Of course, you can't print that," is one of his favorite remarks while talking about

what he did and saw while he was in Holland, and he means what he says. The main reason for his reticence is that he did not content himself with doing his regular work for the Western Electric Company, but spent much of his time at the United States Legation, where his extensive knowledge of languages made him an exceedingly useful person. And it is the information which he gained while helping at the Legation that Mr. Stein cannot reveal. Needless to say, it constitutes the most interesting portion of his experience, but the readers of the NEWS will realize that to publish it at this time would help to give aid and comfort to the enemy.

There are a number of things, however, that Mr. Stein is permitted to tell about, for Holland has been alive with war news during the last three years. Some of it has filtered through to this country, but much has not yet transpired.

For example, how many of the readers of the NEWS know that benevolent societies in Holland, corresponding roughly to our American fresh air societies, but operating upon a much more ambitious scale, have been entertaining thousands of German children for a week or more at a time? These groups of German children, some of them as much as fourteen or fifteen years of age, have been sent from all parts of Germany to spend brief vacations in Holland. Mr. Stein's house in the outskirts of the Dutch capital was on the road along which these children used to march on the way to and from the seashore. In the early months of the war they sang German patriotic songs as they trudged along, but that little custom gradually fell into disuse, as the "Deutschland Uber Alles" idea became nothing more than a rosy dream. The Dutch people objected to hearing these songs and that also helped to put an end to the singing.

Of late, according to Mr. Stein, these gigantic fresh air parties lost some of their popularity. The half starved German youngsters not only enjoyed the food and lodging which their kind Dutch friends provided, but also contrived to take back with them various contraband

articles and considerable valuable information which the Kaiser's paid spies had been unable to get.

As for the paid spies, Holland is swarming with them. It is hard to say whether there are more spies, however, than there are deserters from the Germany army or navy who have grown weary of fighting and have made their way across the border. Strangely enough the deserters all want to go to America. There must be fully 70,000 of them in Holland, Mr. Stein reports, and up to the time this country entered the war they all thought that they would have no trouble in getting into the United States. It was quite a shock to most of them to find that they had to remain in Holland; that country probably was a little too near home for comfort. Nobody seems to like the deserters. They can't get work, and they resort to petty thieving and other equally obnoxious ways of getting their living.

In contrast to the deserters are the escaped prisoners of war from German detention camps, who now and then manage to make their way into Holland. Perhaps the strangest tale of all was told to Mr. Stein by a French officer, who turned up one day in The Hague. He had been captured almost at the beginning of the war and was confined at Ingolstadt, which is in the southeastern corner of Germany.

In the three years of his imprisonment he made three unsuccessful attempts to break away, but each time made the mistake of heading for Switzerland, the nearest neutral country. Naturally all the roads to Switzerland were well guarded and he was recaptured.

After the first attempt he was punished by being placed in solitary confinement for one month, and the penalty was increased each time until when he was brought back after his third dash for liberty, he was sentenced to six months' solitary confinement. He never finished the term, however, because it suddenly occurred to him that if he really wanted to get out of Germany the way to do it was to take some other route than the closely watched roads to Switzerland.

His first task was to get out of the camp itself, and that was fairly easily accomplished. He had plenty of money, so he used some of it to bribe one of his guards, who furnished him with some civilian clothing and arranged to hide him in the wagon which took the camp's soiled clothes to the laundry. Buried deep under a heap of unwashed garments he was driven out of the camp. He changed his uniform for the civilian clothes and, when the wagon came to a stop, managed to crawl out unobserved.

Then came the astonishing part of the whole affair. We all have read about the way the Germans keep tab on travelers within the country, but in this case at least their efficiency methods were not in working order. The French officer strolled down to the railroad station,

bought a second-class ticket to Aix La Chapelle, and when his train came along, began his journey to the distant Dutch border. It was a forty-eight hour trip, but no one molested him at any point. At Leipsig, for example, he got out and ate a meal in the station restaurant, and repeated the trick at Cologne. He spoke German just well enough to disarm suspicion, and nobody saw fit to worry about him. He ended his long trip by walking across the border from Aix La Chapelle into Holland.

It sounds easy enough now, but the officer admitted to Mr. Stein that he did not enjoy his long ride as much as he might have if his mind had been free from the fear of arrest.

Living conditions in Holland are none too pleasant, according to Mr. Stein, who furnished some figures for the readers of the News. Of the attitude of the various classes toward the belligerent powers, he has this to say:

"The pro-Ally and pro-German feeling in the country is distributed somewhat as follows: The Queen is strong pro-French, but the Queen-Mother is just the reverse, strongly pro-German. The Prince, due to his origin, is, of course, pro-German, and is not at all liked by the people. At the beginning of the war he acted in unison with the German army when it advanced on Belgium, and due to this activity was released at once from all connection with the Dutch army. He still headed a Red Cross movement, but recently has not shown much activity in connection with it. He occupies himself with sports and boy scout movements.

"The nobility in Holland and the Dutch court are pro-German as a number are of German origin or intermarried with the German nobility or 'Junkerklasse.' This is also true of the older officers in the army. The younger officers, or the rank and file in the army, and the Dutch people are largely pro-Ally, and to sum up, about 75 per cent. of the country is pro-Ally.

"The feeling in Holland against America is rather strong, since the United States stopped exports to that country. The press as well as the business people are continually discussing the question and seem to think that due to the part the Dutch played in settling

first in the United States they should be subject to unusual consideration."

Lack of space prevents the News from printing all that Mr. Stein has to say on the food and coal situation in Holland, but there is room for a few words:

"The food situation is not as yet so serious as I find it generally accepted here. I have no data as regards the country's stocks, but I have been told that there would be enough to go on as at present until February or March. A large number of items of foods are rationed and controlled by cards or coupon books. The prices on the average are about 40 to 50 per cent. higher than pre-war prices.

"The most serious condition in life's necessities is the coal and gas situation. Both items have been rationed, and of coal, $\frac{3}{4}$ ton is allowed per household for the period from August 1, 1917, to April 1, 1918. In addition to this, 22 cubic meters of gas is allowed. Nearly everybody cooks with gas and uses it also for lighting. If electricity is used for light, the gas ration is reduced. This is entirely too little to cook the food and keep warm over the winter. Coal is reaching Holland both from England and Germany, but even with the small output from the mines in the southern part of the country, it is not enough to be able to increase these rations.

"Much has been said about the cattle feed required. It is generally considered that at least 50% of the cattle would have to be killed off, due to the shortage of feed, but up to the time of my departure no evidence of this was noticeable. Pigs seem to be scarcer, but this is not due to the feed shortage. Several times permits have been issued for the exportation of pigs and pork, and then large amounts were sent to Germany and some to England; the export to the latter country has been small, however."

In regard to the difficulty of railroad travel in Holland, a few words may be of interest:

"In the spring of 1917 railroad passenger traffic was materially decreased due to an attempt at fuel conservation. Railroad fares were increased 50% to discourage traveling for pleasure, and train service was reduced 60%. Formerly passengers were not permitted to stand up in the compartments, but now this rule has been abandoned. The railroads are owned by the Government."

Mr. Stein has been an employee of the Company for sixteen years. He began work in the inspection department in New York on March 13, 1902. He was made Chief Inspector seven years later and in June, 1910, was sent to Antwerp. Since that time he has been in Europe continuously, returning to this country only a month or two ago. He is now working in the General Distributing Department in New York.



One of the most quiet spots in all Europe at the present time—the Peace Palace at The Hague, built by Andrew Carnegie

My Experiences in the Russian Revolution

By A. E. Reinke

(This is the first of a series of three articles about the dawn of the new era in Russia written by Mr. Reinke, the Company's chief engineer in Europe, who was in Petrograd when the first outbreak occurred.)

WHEN I arrived in Petrograd at midnight on March 1, 1917, ten days before the Revolution broke out, the reduced illumination, the general desertion of the station and the bitter cold all helped to increase the mystery that hung heavy in the atmosphere. Riots had been expected that day and were scheduled for the next, my companion whispered to me as we drove through the deserted streets. It was still advisable to whisper any political utterance, for the *izvozchik* who drove us might be a police spy. These rumors of riots continued persistently for ten days. In these ten days I learned a few things about the operation of the old police system that helped to explain the ferocity with which the people turned on the police when the storm broke.

The old autocracy maintained its iron grip on the population of 175,000,000 largely through its police system. Every policeman—the man on the beat and the man in civilian clothes—was an employee of the Government. His pay was kept low, at about \$15 a month, so that he was forced to graft on the retail stores in his district to make a living. He usually was modest in his demands, and with an attempt at fairness distributed his levy over all the stores according to what the traffic would bear. The individual retailer was thus hit for not more than a few roubles a week. (A rouble was worth 50 cents when war broke out.) A refusal to pay at once involved the storekeeper in an endless series of fines by the district police station for breaking the innumerable regulations, otherwise little enforced.

The authorities tolerated this grafting, provided the policeman played the game, particularly the political game of the autocracy. The moment he failed, the strict laws against bribery were enforced, and off he went to Siberia.

The political secret police system was even more detestable. Practically every person in the empire, even the ministers of the state, was under police surveillance. The system of spying thus was complete. The ranks of workmen, clerks, stenographers, waiters, cab drivers, servants, students, etc., teemed with spies. People never discussed political matters with any one. The best friend might be a spy. The usual simple process of

enlisting spies consisted in releasing a young fellow hauled up in court for some offence, on his promise to enter the secret police service while continuing his regular employment. From that moment he was held firmly by the police authorities for the rest of his life. If he failed, if he weakened, he went to Siberia.

Spies were engaged to watch the spies so as to keep a check on them. I was told that in our Petrograd factory of about 1,000 workmen we lost annually about six men, who simply disappeared. They usually had made some criticism of the Government that was promptly reported. Sometimes the man was banished to some distant province or Siberia, where his family was permitted to rejoin him, but usually he was not heard from again. Many were executed, after a secret mock trial; some died in prison simply forgotten. There is little exaggeration in what Tolstoy, Dostojewsky, Gorky and others have told us in their novels about Russian police conditions.



A. E. Reinke

The Revolution broke out Saturday, March 11, in a series of bread riots. The police and a few companies of Cossacks attempted, as usual, to put down the disturbances by shooting into the mobs. The rioting increased in violence, so that the Government was forced to call out additional troops. These soldiers, mostly young recruits from the country, refused to fire on the people and presently began to side with the people against the Government. By Monday evening the ministers of the Government had been arrested by the Revolutionists, the arsenals and police stations stormed, and the Peter and Paul Fortress, opposite the Winter Palace, captured. The police, thus abandoned by the troops, retreated with the machine-guns and provisions into the garrets of houses and steeples of churches. The fight with the police continued furiously for four days more. By Saturday, the 18th, the police were finally overwhelmed and killed or dispersed.

We, who lived in Petrograd those days, did not have such a clear picture of the course of events; far from it. There were no newspapers and Petrograd was practically cut off from the rest of the country for days. We depended entirely on rumors and these were of the wildest kind. We felt for days that we were living through one of the usual Russian riots that would ulti-



Every Workman that Applied Received a Rifle, Bayonet and Cartridges to Defend the Revolution. These Arms Have Been Retained to this Day

mately be put down by Government troops, with the characteristic Russian brutality and thoroughness. Not until we heard of the Czar's abdication on Monday, the 20th, did we realize that we had lived through a revolution after all.

For a whole week the air was filled with rifle fire, the rattle of the machine-gun and occasionally the boom of artillery. The fighting often continued late into the night. It was at first concentrated to a few sections of the town, but when the police retreated to the house tops it was scattered all over. The locations of these many police groups became known only very slowly. The dislodgment of each group meant a separate fight. The police often moved from house to house in the same block, making capture difficult. Occasionally a private sympathizer of the monarchy took a shot or two from his window at the soldiers in the street. It was a "rough house" on a large scale.

As I became accustomed to the firing the noise reminded me of some of the active Fourth of July celebrations in the eighties when I was a youngster in Chicago, except that every shot meant a bullet flying somewhere and also the machine-gun kind of noise had not been invented in the days of my youth. If noise is a measure of the success of a celebration, the Russians did full justice to the birth of their Independence Day.

The best estimate I obtained placed the number of killed at 3,000 to 5,000; the number of wounded ran into the ten thousands. No careful count was possible under the circumstances. Russians who had seen the bloodshed of the days of 1905 told me that casualties were low measured against the results accomplished. The number of killed in other towns was very low. These towns followed the Petrograd lead. With the complete routing of the Petrograd police, the police of other towns quickly dispersed with practically no show of resistance.

When the storm broke on Saturday I was on the Nevsky Prospect, the Broadway of Petrograd, and escaped into the Singer Building. From the balcony of

the American Consulate I saw the *gardavoi* (the mounted police) riding into the mobs and beating the people down with their *nagaikas*—a short leather whip with its tip weighted with lead. The people roared and hooted and threw stones and bottles at the police. The people had as yet no better arms. The mob was driven back gradually, taking their wounded with them. A woman killed in the rioting was carried into the Singer Building. It seemed time for me to move on.

My hotel, the "Europe," is located on the Nevsky Prospect, with its main entrance on a large cross street. (H on the map, on page 13, shows the point.) When I got near the hotel corner, a mob that simply filled the Nevsky from edge to edge came tearing down the street towards me, while bayonets were blinking in the distance and bullets flying. I established the engineering department's record for the hundred-yard dash, making that hotel corner before the mob cut me off. I raced down the cross street with a thousand others, many turning towards the hotel. We found the doors carefully bolted. After vigorous pounding we finally convinced the porter that we wanted to get in and we got in. Hundreds were killed in that mob.

When I went out later I found the Nevsky nearly deserted. Long rows of ugly-looking Cossacks on their ponies were now drawn at intervals across the street, stopping all traffic. The Government seemed to have the situation well in hand. Large splotches of red on the white snow bore mute witness to happenings earlier in the day.



A Mob in the Nevsky Prospect Opposite the Hotel d' Europe Watching Army Motor Trucks Piled with Armed Soldiers. The Nevsky is Half Again as Broad as Fifth Avenue

The next morning we were informed by the hotel manager, who was pale and nervous, not to leave the hotel. A large proclamation by the Government prohibited all gatherings and warned citizens off the street. I started out, nevertheless, later to keep a dinner appointment with Mr. Joseph, the director of our Petrograd House. The Nevsky was perfectly calm at that moment, scarcely a soul to be seen. It was not unusual for a street thronged with people to become practically deserted when the police began to fire. When I returned at midnight, through black and deserted streets, I found the Nevsky completely guarded by Government troops.

An attempt was made on Monday to operate the street cars, but many were derailed. Our factory workmen had not appeared. From our office windows we could see crowds with drawn revolvers capturing Government officials and leading them off. The policeman of our district was caught and killed by the people who rolled a big box on him. I saw soldiers who had mutinied and broken ranks run down the street in a bayonet charge, towards a point where the revolutionists needed help. Motor cars flying the red flag of the Revolution and carrying armed soldiers were racing through the streets. Occasionally an armored car with machine-guns and piercing siren speeded by small groups of people who were gathered

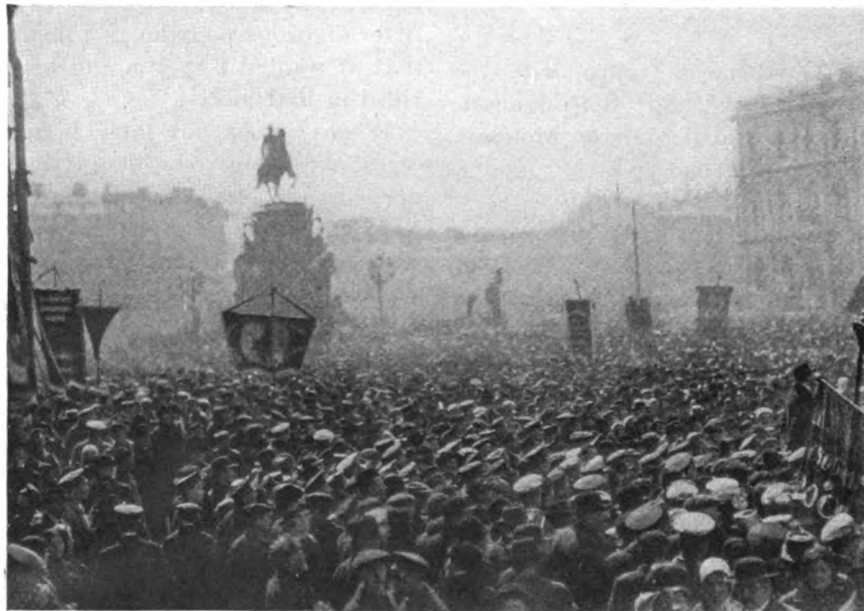

A Mob in the Isaac's Cathedral Square

discussing the situation. I began to take an interest, about Tuesday, in the train schedules and railway facilities available and started out on a walk that ultimately took me through nine miles of city streets (along the dotted line on the map). I saw police stations blazing along the route, also the large Court House, with no effort to fight the fire. From the windows of the Political Secret Police Building a mob was throwing tons of police documents on a huge bon-fire in the street. At several points barricades had been erected, with pairs of three-inch cannon and ammunition cases in place.

The people had already grown accustomed to the rifle fire and began to wander about the streets, little concerned by the possibility of being hit by a police bullet from the house-top. The occasional closing in of a small group in the distance told of a bullet that had not missed. A Russian explained to me that a bullet fired on the level at a crowd is a dangerous thing—a bullet fired vertically from a house-top is something almost harmless, as he put it. A large ambulance unloaded its

dead before a hospital. Groups of revolutionary soldiers marched through the streets guarding prisoners. A long line of solemn-looking cadets, who refused to join the people, passed under heavy revolutionary guard on the way to the prison. All retail stores were heavily shuttered. I only saw a few bakeries and munition stores broken into.

The railway station I found heavily guarded, and all train traffic suspended. It was a precaution to prevent Ministers of the Government, still at large, from escaping. The revolutionary soldiers in charge were kindly spoken and free from excitement. The waiting rooms were jammed with soldiers drinking tea in a thick, smoky atmosphere. The soldiers for days were largely fed by the public at buffets started everywhere. Mr. Joseph's daughters worked hard at such tea stations carrying in provisions while bullets were whistling.

Curiously I did not see a single speaker haranguing the crowd these days nor for weeks afterwards. The Russian had not yet found his political tongue. When Revolutionary pamphlets first appeared, it was common to see a man reading one of them to an eager crowd around him—many unable to read themselves.

While alone one afternoon in the office of Mr. Otto, director of our Petrograd house, the door was violently thrown open and a six-foot marine with a revolver a foot long—it looked two at the time—covered me with a nervous finger on the trigger. My Russian is not fluent, and was particularly deficient just then. Fortunately one of our employees came in and explained that I was not a policeman in spite of appearances, but only a harmless American telephone engineer. The invader withdrew with a growl. I followed him into the general office and found that he and a partner, carrying a bayoneted rifle with a dirty red rag tied to it as a flag, had chased the office force out of the building. The partner, who had presumably enjoyed a high school education, was clumsily writing a note officially closing the factory in the name of the Revolution. Meanwhile the man with the revolver swung that plaything around nonchalantly, carelessly pointing it at one or the other until I feared he'd have to explain with tears in his eyes he didn't know it was loaded. I had a better view of the weapon than he and could have warned him.

The enthusiastic crowds opened up the city prisons

and released not only all the political prisoners, but also 5,000 thugs, murderers and burglars. Each criminal as he left received a uniform and a gun, the one to appear in public decently dressed, and the other to defend his reputation and the newly won liberty. Many of these law-breaking specialists organized searching parties, that visited house after house. Their trade was never so free from interference nor so prosperous.

The large arsenals were captured on Monday. Rifles and cartridges were freely distributed to all who applied. Every workman, every boy carried an army rifle in the streets. Over 2,000 machine-guns were distributed among those who later supported the Bolsheviki. It was an interesting and ticklish sight to see a young Russian boy of fifteen clumsily handling a gun and trying to fit a cartridge in place. Children walked about with huge cavalry sabers. Self-appointed student guards often were seen armed with Turkish sabers or Japanese swords with wonderfully carved handles. The real menace, however, was the soldier wandering about, with a bayoneted rifle carelessly tucked under his arm at an angle to threaten the eyes of the person walking behind him. I had some narrow escapes.

I saw some fine exhibitions of the Russian's coolness when in danger. People lined up daily as usual at the bakeries; when a machine-gun began to operate around the corner, the line dispersed;

when the radius and direction of the gun fire had been determined, the line reformed. There was no nervousness or hysteria. The crowds ran when facing company fire. The individual bullet held no terrors. Mr. Otto and I crossed the large square of the Isaac's Cathedral, in whose spire the police were ensconced. An occasional bullet that rang through the cold, crisp air told us that the police were on the job. There were at least a hundred persons crossing the square at that time in all directions. There was no speeding up of their gait, while I looked longingly at the tree trunks which we passed.

Mr. Otto and I crossed the Nevsky one day, when an armored car pulled up suddenly behind us and opened up a machine gun fire over our heads at the top of a building. We "beat it" for the nearest brick wall and leaned against it to escape stray bullets. Needless to say, we

did some leaning. When the line of the barrage fire had been established we began to look for the target, and saw a row of windows smashed and a mutilated cornice. We didn't stop to see the ninth inning of that game.

In the meantime we went through the best assorted collection of scares I ever experienced. It was rumored one day that our hotel might be attacked. In fact some crank did shoot from the roof; this act brought on a room to room search, but nothing more serious happened. The Astoria Hotel, the second largest in town, was less fortunate. Some ill-advised officer in the hotel had taken a pot-shot at the soldiers in the street. The latter formed at once for mass attack and stormed the hotel. A bloody fight ensued in the hotel corridors with the guests, many of them officers. Hundreds of persons were killed on both sides. Officers were slaughtered. Some of them wounded were let down from the upper windows on ropes, hanging by their necks. It was war and of the

type Sherman described. The interior of the hotel was completely wrecked, every stick of furniture, every chandelier was smashed. I never saw a more perfect job. Revolutionary troops were placed in the Hotel Europe that day. They barricaded the lower windows with mattresses and tables, awaiting the arrival of Government troops. It was a protection to us of a decidedly dubious nature. That evening I decided to spend the night with Mr. Otto.



The Isaac's Cathedral and on the Right the Astoria Hotel. The Windows were Boarded up After the Fight. The Russian Soldiers are Drilling Practically Under a Commander Elected by the Men

The town was filled with groups of armed soldiers, many criminals in uniform, making a house to house search for weapons. They preferred to go into the homes of the well-to-do and much disappeared in these searches besides the confiscated revolvers. The parties occasionally were drunk, which did not help in an intelligent performance of duty. There was no protection whatever against them, no police and no military force. A refusal by a tenant of an apartment to open the door at once aroused the suspicion that the house harbored a policeman; a battering down of the doors promptly followed. When the door bell rang the family usually listened and wondered what next. Mr. Otto's door bell rang violently at one o'clock one night when I was staying with him. After much hesitation, a careful opening of the door revealed a soldier with his rifle. He identified himself, however, as kindly intentioned, proving to be



The City Prison from Which Thousands of Burglars and Murderers were Liberated. The Prison was then Set on Fire

the cook's suitor. He regaled the family with gruesome tales of slaughter, and a series of rumors, ranging from the blowing up of the Winter Palace the following day, to an impending Anti-German riot. Those tales and the occasional firing of shots in the street below did not produce much drowsiness that night. The next night I decided to take a chance sleeping at the hotel again; it seemed quieter after all. I always carried with me a slice of dried bread, a shaving kit and a Russian dictionary as I never knew when I might be cut off from the hotel and where I might have to put up for the night.

Though there was not much inclination among our people to discuss business matters, I walked regularly to our office through two miles of city streets, often by a round-about route to avoid riotous sections of the town. It was always advisable to glance up and down a cross-street to be sure of a safe crossing. A half hour after I passed the Winter Palace, one afternoon, there occurred a pitched battle between soldiers on the Neva Bridge and policemen with machine-guns behind a stone wall around the Czar's garden; a good many dropped in that little affair. The police were routed. After that experience I made it a rule always to pass places a half-hour before. It saved me doctors' bills and an explanation to my wife, for carelessness.

There were repeated rumors of an Anti-German uprising. There are in Petrograd many Russians from the Baltic Provinces with German names. Russian mobs proved in the bloody anti-German riots in Moscow, in 1915, that they make no fine distinctions. Mr. Otto carefully removed the name plate from his door, and some of us with names that do not sound Irish, even in Russia, breathed more freely, when the worst was over. The rattle of the machine gun is particularly annoying in the quiet of the night. I left Mr. Otto's home at midnight on one of the evenings when the hotel seemed

more restful and had not taken a hundred steps up a dark and deserted street when the bark of a machine gun burst out into the still air from a church steeple in the next block followed by the roar of battle. I threw my legs at once into high gear and speeded off in the opposite direction. I wasn't a bit curious about the point of the argument.

On the whole there was little drunkenness. Stores of wine and beer, when discovered, were, as a rule destroyed and poured into the gutter. If that mob had had free access to vodka, the story of the Revolution would have been far different and the destruction of life and property appalling. The Russian peasant, when drunk, practically ceases to be a human being and readily turns to the destruction of life and property.

The first reassurance came on Monday, March 20, with the news of the capture of the Czar, while attempting to escape to the army at the front. His declaration of abdication appeared on a handbill printed by the Revolutionary Government and distributed widely by soldiers from motor cars. Groups of people collected everywhere and read the news with apparent signs of relief and pleasure. The dream of centuries had come true: the people were at last freed from the yoke of despotism that held a people down worse than any system of slavery. It came all as in a dream, unexpected, and far more easily than the most optimistic revolutionist had ever hoped for.

The people took it quietly and calmly as they do all things. They had forgotten how to dance and sing in a national happiness. The Czar and his crowd had ground the capacity for national joy out of the lives of their people.

A second article by Mr. Reinke, in which he will tell of his experiences during the first few months after the overthrow of the Czar, will appear in the March issue of the News.

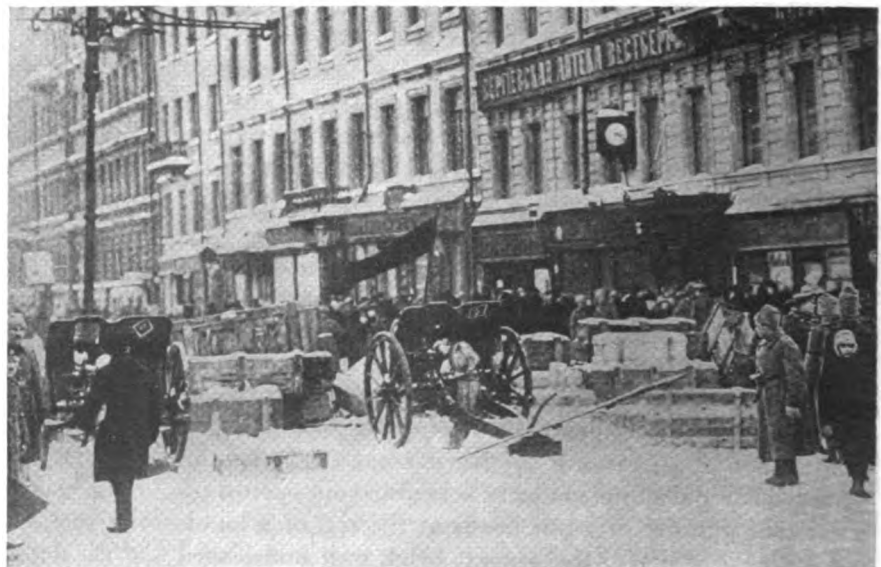

A Good View of the Barricades Defended by Field Pieces Pointing up the Street in Readiness for the Out-of-town Troops

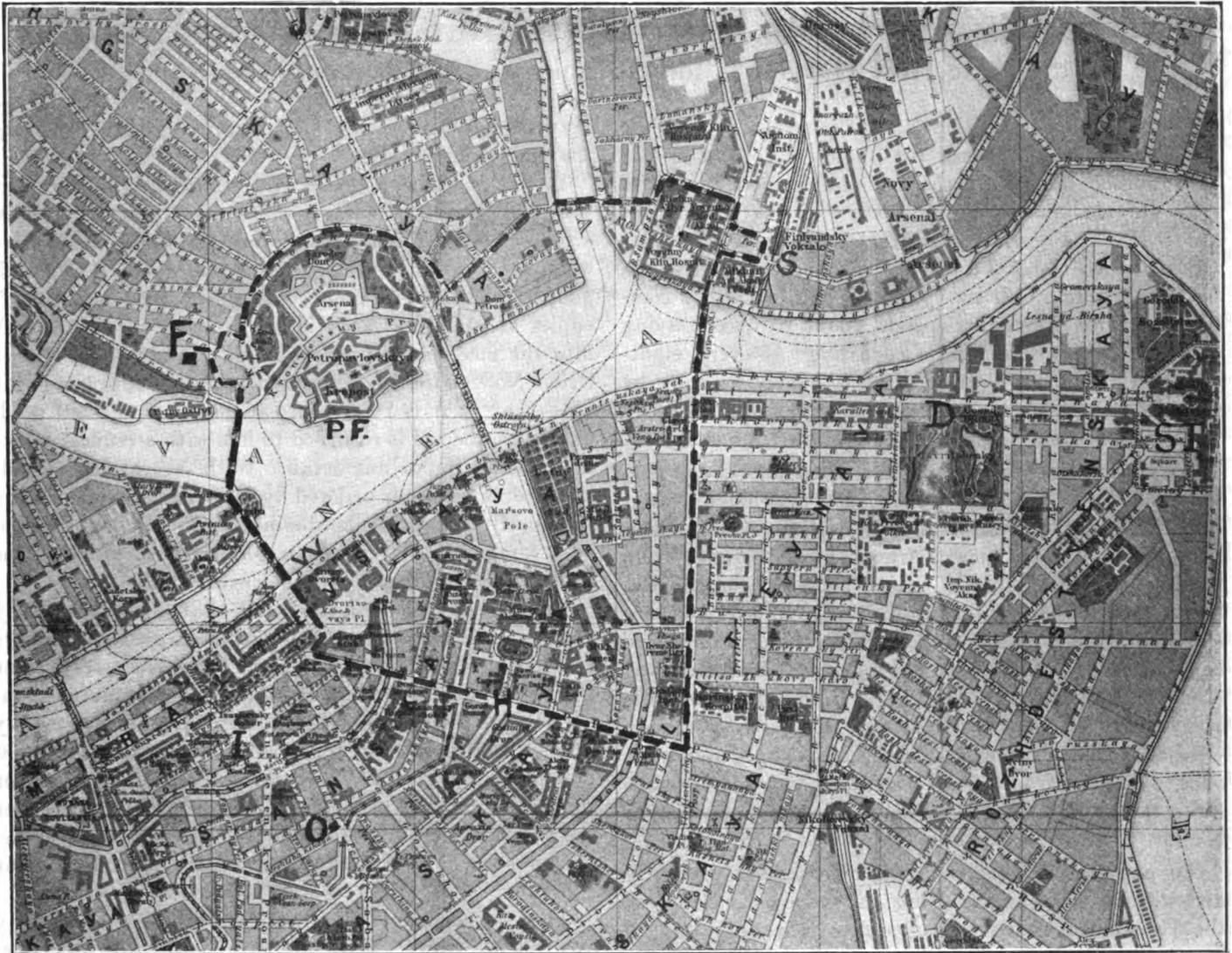

A MAP OF A PART OF PETROGRAD WHERE MOST OF THE RIOTING OCCURRED

F is Factory of Our Allied House; J is Home of Mr. Joseph; O is Home of Mr. Otto; PF is the Peter Paul Fortress; W is the Winter Palace Where the Czar Formerly Lived; I is the Isaac's Cathedral; H is the Hotel d' Europe on the Nevsky Prospect; D is the State Duma; SI is the Smolny Institute, Where the Bolsheviki Meet; S is the Finnish Railway Station.



A Little German "Kultur"



The photographs on the left and right show both sides of the medal struck off by the Germans to celebrate the sinking of the *Lusitania*. The replica of this medal from which these photographs were made was brought to this country by O. F. Stein, whose experiences in Holland are related on another page. In the illustration on the left passengers are shown buying



ing tickets at the Cunard Line office despite the warnings issued by the German Embassy. One of the passengers is carrying a newspaper containing this warning and Death is acting as the ticket-seller.

The Long Green and the Red Tape

Showing How Hard It Is for Hawthorne to Get Rid of Its Money

THE voucher section at Hawthorne in a single month issues checks for about three and a half million dollars of the Company's money just to settle outside bills, taking no account of what is paid out for salaries. Figuring 24 working days a month; that makes about \$146,000 a day. From that, if your arithmetic is hitting on all six cylinders, you can easily compute that the Company spends about \$18,250 paying outside bills for Hawthorne each hour of every eight-hour working day. Getting down to money we know by sight, that means a five-dollar bill every time the clock ticks off a second.

Barring things to eat and a few other luxuries, a person could buy almost everything with that much money. And the Western does. Almost everything from almost everywhere—Indian mica, Turkish emery, Norway iron, South American asphalt, crude rubber from Africa, South America, Mexico, Ceylon, Borneo and other tropical lands; whale oil from wherever the whale happens to be; lard, leather, bank-note paper, rhinoceros hide, dyes, chemicals of all kinds, felt, tape, jute, silk—in short, everything from dirt to diamonds. That is near enough—so near that a member of our purchasing department once won a bet from a man who thought he could name *three things* the Western Electric Company had never bought.

To pay for all these multifarious articles promptly and without mistakes, is a big and important detail of the Hawthorne plant management. The only way to handle it without error is by a prescribed routine, so checked and counter-checked that no mistake can get far undiscovered. For that matter, such routine is imperative in handling thousands of other details in the management of our big factory. "Red tape" has its drawbacks, but it would be absolutely impossible to conduct business on a large scale without it. Underlying all of it is a firm substratum of common sense. A glimpse of

Hawthorne's bill-paying machinery may serve to bring that fact home to you.

In this instance, at least, you will be able to recognize that the "red tape" starts off sensibly enough. When a bill comes in, the first move toward paying it is to see whether Hawthorne ever ordered the goods. Since all goods are ordered on numbered "Purchase Requisitions," copies of which are kept in the voucher section, a look into the files shows just what was called for on "Your Order No. So-and-So," referred to by the supplier in his bill—that is, it is referred to if he wants the bill paid. Otherwise the bill is returned to him with a request to attend to this important detail. With several million dollars' worth of goods ordered by Hawthorne every month, the justly unpopular needle-in-a-hay-stack game would be a kindergarten recreation compared to locating the order corresponding to an unidentified bill.

Besides showing that the goods charged were actually ordered, the purchase requisition also generally shows whether they are billed at the correct price. Whenever there is a price agreement the purchasing department incorporates the price in the order. They do not merely order "1000 pounds of tool steel." They specify "1000 pounds of tool steel at 38 cents per pound," or whatever the price may be. When the price shows on the order the voucher section checks the bill as correct for price. Otherwise it is sent to the purchasing department for checking.

That is common sense, isn't it, to see that nobody overcharges you? With obligations the size of Hawthorne's it means the difference between bank and bankruptcy.

The next move in the bill handling routine may puzzle you a little. It is called "Classifying" and its outward manifestation is a group of figures written across the bill—say, "37-151-138." They show that the bill is to be charged on the ledger accounts under "Shop Raw Material," that it is to be entered on the sub-classification cards showing steel bought and that the material was ordered by Shop Records Section 6138. All of this information is necessary in keeping track of Hawthorne's expenses. "37" shows the ledger account, "151" stands for "steel" in the list of raw materials, and "138" is the department designation of the organization that ordered the material.

There are numerous other classifications with other meanings, all of which have to do with the complications of the bookkeeping system. You probably don't care for the details, as long as you see the reason for it all.

In these evil days of the H. C. of L. you probably find it worth while to save 20 or 30 cents every month by paying the electric light bill before the discount has expired. This is not an attempt to change the subject. It is merely a vindication of another step in Hawthorne's bill passing routine, which involves taking advantage of discounts, or (what amounts to the same thing) avoid-

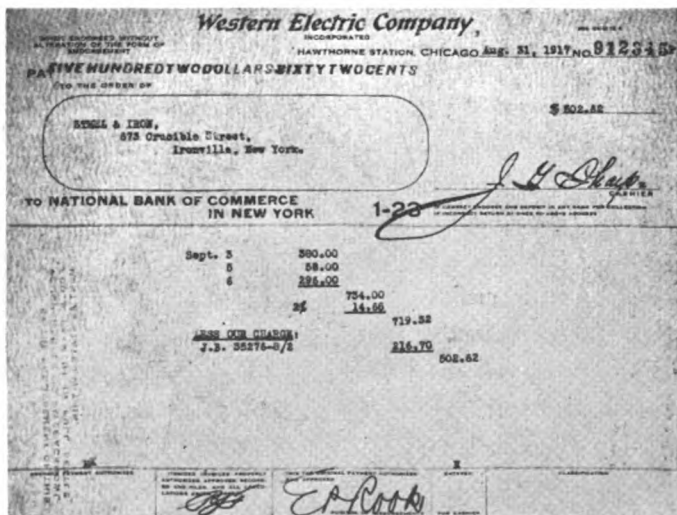

A Western Electric Voucher

ing penalties for delayed payment. Some suppliers allow a certain percentage to be deducted from their bills if paid within a specified time, while others charge interest on the amount due unless payment is made by a certain date. That, of course, is perfectly reasonable, for if they had to borrow money to run their businesses because of inability to collect their debts, they would have to pay interest on the borrowed capital.

By the same token, since operating capital is worth money, it is poor business to pay a bill earlier than its terms specify. Consequently the exact date and terms of payment are marked on every bill. (Duplicates of the bills, similarly stamped, and filed according to date of payment, serve to show what bills should clear through the voucher section each day.) The clerks in charge of this so-called "term stamping" get their information from bound copies of the Company's purchase agreements with suppliers. After a little experience they can mark most of the bills from memory, but they take no chances in cases where they feel the least bit doubtful. A two per cent. discount overlooked on a bill for \$3,000 costs the Company \$60.

Now before paying for the goods, it would be a sensible thing to make sure they were delivered, wouldn't it, and that they were received in good condition? That is done this way: A receiving entry is made out for every lot of goods that reaches Hawthorne. It shows what firm the goods were from, the exact amount of everything shipped, transportation charges if any, and the condition of the goods. The receiving organization sends a copy of this important document to the voucher section, where it is filed to await the bill—provided the bill doesn't beat it in!

A comparison of the receiving entry, the bill and the purchase order shows whether everything billed has arrived in good condition and whether the Company has paid any transportation charges that should have been paid by the supplier. In the latter event a "contra-

charge" is made out against the supplier for the amount involved. This contra-charge is simply a bill sent to the supplier, stating that he owes the Company a certain amount, and why. In this case it is for transportation charges, but a similar bill would be sent covering the value of goods paid for, but later found defective and returned—in brief, in all cases where the Company has overpaid its obligations from any cause whatsoever. The supplier may pay these charges if he likes, but usually he lets them stand, to be deducted from subsequent bills he may have against us.

So, before a bill is finally passed, one step in the routine is to see that such contra-charges are deducted, if any exist.

The bills are finally paid by "vouchers." (See illustration.) A voucher is simply a check drawn on one of the Company's banks, but it differs from an ordinary check in that it bears on its face a list of the bills covered by it. This makes it a receipt for those bills as soon as it is cashed. If several bills are due to one supplier at the same time they are, of course, all paid by a single voucher.

Three signatures are necessary on a Hawthorne voucher. The voucher clerk's initials show that the bills to be paid have passed through the routine just outlined and that they and the voucher itself are correct in every detail. The disbursements auditor also signs. It is his duty to scrutinize every voucher for any evidence of error and to check up a certain proportion of them in detail. Last comes the signature of the cashier, which is the one recognized by the banks.

That is practically all there is to the bill-vouchering routine—just a common sense way of doing on a large scale what you yourself do on a small scale in paying your own bills.

But after all, it's a nuisance to have to pay bills, any way you look at it.



A Relic of the Good Old Days

The bill on the right was discovered recently among the papers of one of the Company's old customers. The high cost of living had not come into its own when this bill was rendered and paid. Salammoniac cost only eight cents a pound then, and now it sells for fifteen cents. The bill is receipted by E. R. Gilmore, at that time cashier of the New York house, but now the Company's assistant treasurer at Chicago.

M. S. Brooks & Son, the customers to whom this bill was sent, have also survived the test of time and are still doing business. They are still on the Company's books, and the News is indebted to them for this old bill.

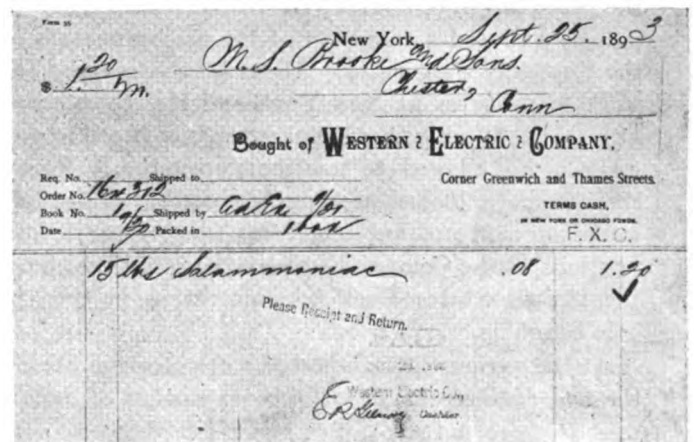

TALKING IT OVER

MR. SWOPE SHARES HIS HONORS

Editor of THE NEWS:

I have received your request for permission to publish in THE NEWS, so that others in the Western Electric Company may have the opportunity of seeing it, a reproduction of the decoration which was conferred upon me by His Imperial Majesty, the Emperor of Japan.

Since this decoration was given to me as a representative of the Western Electric Company, and therefore of all my associates, it seems fitting that it should be reproduced in THE NEWS. It was conferred upon us largely for the welcome which we have extended and the assistance we have given to the various Japanese who have visited us from time to time.

As I have said on another page, the Japanese have appreciated and valued our assistance and services, even to a greater extent than I think we deserve. Co-operation and assistance can always be given more whole-heartedly if one is sure that it is appreciated, and that use is made of it.

This decoration is a mark of their great appreciation, and the upbuilding of the telephone service in Japan shows the use that they have made of the service that we have rendered. Both should encourage us to be of even greater assistance in the future, than we have been in the past.

GERARD SWOPE.

THOSE FIVE COALLESS DAYS

THE NEWS has no apology to offer for the lateness of its appearance this month, and most of its readers will guess the reason for the delay, even before they read the few words of explanation which follow. Yes, it was the five-day period of coallessness decreed by Dr. Garfield.

As most employees of the Company know by reason of their own experience (except those west of the Mississippi, of course) the five-day suspension of industry caused a cessation of the major portion of the Company's activities. About 70 per cent. of the work in progress at New York and Hawthorne was at a standstill, only those departments engaged in war work being allowed to continue operation. For a short while it looked as though even the war orders would be held up, but telegrams exempting various portions of the Company's plants were received from the United States Fuel Administration in time to avoid trouble.

At the various branch houses work stopped during the five coalless days, with the exception of repair

and maintenance work for the telephone companies.

As for the NEWS itself, all work in progress on preparation of engravings, and even the printing, came to an end. It was a case of marking time for five days, and accepting the unfortunate delay as a part of the great task of winning the war to which the whole nation is pledged.

FROM BEYOND THE SEAS

AT times like these, when news from foreign lands so often is distorted and misleading, the NEWS is exceedingly fortunate in being able to present to its readers three articles such as those which appear in this issue. Mr. Swope writes about Japan, Mr. Reinke tells about the Russian revolution, and the relation of a few of Mr. Stein's experiences in Holland during the last three years gives a good picture of conditions in that little country.

As most of the readers of the NEWS know, Mr. Swope's trip to the Far East included a visit to China as well as to Japan, and in a future issue he will contribute an article on the celestial republic. Mr. Swope is a keen observer of men and their affairs, so what he has to say about China will be well worth reading.

The article by Mr. Reinke in this issue is the first of a series of three. It covers only the first ten days of the Russian revolution, the period of violence and unrest which attended the overthrow of the Romanoff dynasty which ruled Russia for so many centuries. The second article will tell about conditions in Russia during the five or six months which succeeded the abdication of the Czar. It will appear in the March issue. In his third article in April, Mr. Reinke will discuss the Russian Revolution as a whole, and give his views and opinions about the future development of the great country in which the whole world is so intensely interested at this time.

Few industrial organizations in this country have extended their influence through foreign lands to the extent that the Western Electric Company has done, and the readers of the NEWS are reaping one of the rewards of that policy of friendly invasion.

COPIES OF JANUARY COVER AVAILABLE

A NUMBER of copies of the Service Flag cover which appeared on the January issue of the NEWS are in the hands of the editors, and will be given to those who ask for them as long as the supply lasts. They are printed on good paper and are suitable for framing.

Who's Who at Hawthorne



WHO went to far away Japan to start our cable plant, and now it almost gets his nan because his eyes don't slant? Who came back to the U. S. A. with Jap antiques galore (all made in Perth Amboy, N. J., and one year old or more)? Who smokes a pipe, age-worn and black, whose venom-laden fumes would make a German gas attack seem sweet as spring's first blooms? Who throws

the bull but seldom, too, despite his cowboy name? (Come, movie fans. It's up to you.) Hart. (Not Bill—C. D., Mayme.)

Sunbeam Lamps Give Satisfaction

Within the parlor there were three—
The maid, the Sunbeam Lamp, and he,
Now that's a crowd, without a doubt,
And so the Sunbeam Lamp went out.

W. F. L., New York.

Even the Amateurs Gain Applause

A dinner at the Muehlebach Hotel, a forty-five minute session of amateur vaudeville, and a theater party at the Orpheum were the events which brought to a close a two-day local conference held recently by the Kansas City sales organization. All attempts to find out which of the three was most appreciated were unsuccessful as those who attended were too busy enjoying themselves to make comparisons.

Be that as it may, the portion of the entertainment that is going to be handed down to posterity by publication in the columns of the News is the amateur vaudeville. It was crowded in between the dinner and the regular theatre, but Fred Uhrig was in the chair and he saw to it that no hitch delayed the proceedings. Among the performers were Charles ("Tuey") McCallum, M. C. ("Charlie Chaplin") Butterfield, Bill Murphy, of Oklahoma City, and the Misses O'Gara and Gregg, all strictly Western Electric talent. What they did isn't important, the main point being that they had nerve enough to get up and do something.

A. D. B., Kansas City.

A Light Subject

We have just received the following letter from the Mugwump Mines Company of Forest, Sierra County, California. This is a bona fide letter, dated December 23, and reads as follows:

"When batteries and flashlight lamps are shipped, please see that they are directed here. The cardboard box containing the flashlight on the last shipment was somewhat squeezed and caused the light to burn, and the post-office authorities wanted to know if I were a German spy and demanded that the package be opened to see what kind of a bomb you had shipped to me. Well, there was hardly enough light left to see whether I was a German or not, at any rate I proved to be Scotch and they excused me with instructions to write you and say that you are not to scare them any more."

This is the sort of a letter that news correspondents dream about, for it is literally too good to be true.

C. L. H., San Francisco.

"Know Thyself"

The following quotation is from a letter sent recently to the New York engineering department:

"Our experience has been that we have quoted your concern several times on the same key and each time submitted a sample, but the key was always returned to us with many complaints. The last time we sent you a sample it was of your own make. We merely filed off your name and sent it to you just to see what criticisms you had to offer. The key was severely criticized and returned to us."

H. C. W., New York.

A Live Account for M. A. Curran

Now that we are getting into the milking-machine game, we are having to make some trades which are rather unusual to us. Recently, an agent sent in an order stating he had sold a milking-machine outfit to one of the farmers and had taken in trade two yearling colts, equal to \$180, and the balance in cash.

Inasmuch as the General Department has accommodated us by taking our notes, I am wondering if they are prepared to carry our investment in live stock which we get in trade from the farmers.

F. A. K., Chicago.

Chicago's New Correspondent

D. H. Frick has been appointed correspondent of THE NEWS in Chicago, succeeding W. M. Goodrich, who has enlisted, as told on another page. The new correspondent has been an employee of the Company since August 6, 1906, beginning in the engineering and manufacturing departments at Hawthorne.

He was transferred later to the Chicago sales department and at present is engaged in the associate telephone end of the business.





Employees Who Have Entered the Various Branches of the Military Service Since the Last Issue of the News

General Accounting Department

New York

EWING, J. W., U. S. Army.
PAINTER, W. A., Naval Reserve.

General Sales Distributing

New York

FEENY, J., Quartermasters Reserve Force.
CRISMAN, L. J., Naval Reserve.
DE GRUCHY, F. S., Naval Reserve.
FISH, A. S., U. S. Army.
KERNS, J. H., U. S. Army.
KIRBY, P. S., National Guard.
LANNI, J. A., Reserve Signal Corps.
MOPPERT, E. J., U. S. Army.
SCORSO, G. P., Naval Reserve.
STICKLE, W., Sanitary Corps.
TRAPHAGEN, W. E., U. S. Army.

Philadelphia

SAVAGE, J. A., Naval Reserve.

Omaha

COUPAL, V. P., Jr., Reserve Signal Corps.

Engineering Department

ADAMS, J. K., Reserve Corps of Engineers.
ALLISON, S. W., Ordnance Reserve Corps.
ARZONICO, G. F., Ordnance Reserve Corps.
ARZONICO, J. A., Ordnance Reserve Corps.
BOLLENBACK, A. W., U. S. Navy.
BROWNELL, F. J., Naval Reserve.
FLEET, J. W., National Guard.
GENT, A., Aviation Section, Signal Corps.
HANILY, G. J., Naval Reserve.
HANSEN, R. E., Red Cross Base Unit.
HAYES, L. M., U. S. Army.

HENDRICKSON, C. J., Aviation Section, Signal Corps.
HELM, C. W., Naval Coast Defense.
HEYDT, G. H., U. S. Army.
KLINDWORTH, F. L., Aviation Section, Signal Corps.
MOORE, WM., U. S. Army.
OWEN, N. C., U. S. Army.
PRONTY, A. B. R., Naval Reserve.
REID, J. B., Aviation Section, Signal Corps.
SAVAGE, W. A., Naval Reserve.
SCHNEBBE, J. A., Naval Coast Defense.
SCHULER, T. T., U. S. Navy.
SHERMAN, A. N., Naval Reserve.
SILCOCK, R. Z., Quartermasters Reserve Corps.
STEELE, H. M., Naval Reserve.
SVEKE, H. J., Ordnance Reserve Corps.
YATES, G. A., Aviation Section, Signal Corps.

General Manufacturing Department

Hawthorne

CLARK, I. W., Ordnance Reserve Corps.
DE KOSTER, G., Quartermasters Reserve Corps.
FISHMAN, F. J., Ordnance Reserve Corps.
GILBERT, A. O., Ordnance Reserve Corps.
HARTSEMA, H. J., Reserve Corps of Engineers.
HELMERICH, W. H., Aviation Section, Signal Corps.
HEMPHILL, C. G., Ordnance Reserve Corps.
HILL, C. H., Ambulance Corps.
JANICKI, J., Naval Reserve.
MACDOUGALL, R., Naval Reserve.
MISKELLY, D., Aviation Section, Signal Corps.
NORTON, E., U. S. Army.
PANKRATZ, L., Quartermasters Reserve Corps.
PATNOE, R. A., Ordnance Reserve Corps.
POOLE, R. J., U. S. Army.
THIELEN, A. P., U. S. Army.
WALSH, L. D., Ordnance Reserve Corps.
WALTERS, C. C., Ordnance Reserve Corps.
WEBER, W. O., Quartermasters Reserve Corps.
WILLIAMS, L. W., Aviation Section, Signal Corps.

News from Western Electric Men in Camp and Field



Capt. G. C. Pratt

JUST too late to be published in the last issue of THE NEWS came word that Lieut. George C. Pratt, the secretary of the Company, had gained his captaincy. The promotion actually took place on December 21, but Captain Pratt was not notified until January 4.

The advance in rank does not take Captain Pratt away from Company A, of the 819th Field Signal Battalion (the New York Radio Company), and he will remain in command of that Western Electric outfit, which is still at Camp Sherman, Chillicothe, Ohio. That is to say, most of it is still at Camp Sherman. The following paragraphs from a letter written by Captain Pratt tell what happened to three

of the men who are no longer with the Company:

"The Radio Company is getting along in fine shape and, in spite of the desire of other organizations to get hold of some of the W. E. men on account of unusual qualifications, the original lot who came here are still together, with the exception of Kloth, Gahan and Gates, who left last week to attend the Signal Officers' Training School at Camp Morse, Texas. All three of these men were sergeants. In addition to these we have made the following Sergeants from W. E. men; Helwig, Van Tubergen, Brown, Vroom, Atwood and Timmerman.

"Practically all of the non-commissioned officers were picked from the W. E. men, and this was entirely on account of their merits. We are an Army Corps organization and not a part of any division and will be motorized instead of having horses. This will give us a great deal more time to put on real Signal Corps work which would otherwise go in the care of horses."

George M. Coombs, of the New York house, is now on the *U. S. S. Mt. Vernon*, which is one of the German liners which were taken over by the United States at the outbreak of the war and converted into transports. A letter from him describes briefly a trip to France and return.



Lieut.-Com. D. C. Guest

The naval officer on the left is Lieut. Commander D. C. Guest, who was a specialist in the sales department at Chicago on line construction materials and street lighting. He was a member of the Illinois Naval Reserve and a veteran of the Spanish American War, and when this country declared war on Germany he

was at once called into service.

At first he was in command of the training ship *Dorothea*, stationed at Chicago. He took her to Cleveland, where some repairs were made and from there to the Atlantic Coast where she is now doing patrol duty.

At present he is third in command of the U. S. S. *Oregon*, which is in Pacific waters.

The following letter was received from R. E. Dryer, who was road salesman for Coast Counties when he left the San Francisco house, to join the United States Naval Reserve in San Pedro.

"Pardon the pencil and scribe as this note has been written under unusual conditions, for instance, we are assembled in what is termed a 'Mess Hall'—overcrowded. In one portion one of the mates is trying to sell some Ditty Boxes and in the other corner the phonograph is playing a lively ragtime piece, with the usual hum-drum it is difficult for me to concentrate. Our party arrived a week ago today—all anxious, all curious, all tired from no doubt a restless night, probably thinking what the dawn would bring. We were greeted at Los Angeles by a representative of the Southern Pacific Company, who escorted us to ham and eggs—then to a special electric car to San Pedro, to the training station, a lively sunshiny day. The officers in charge were very courteous, we were given our allotment of cot-bedding, then clothes—then to the quarantine section we were escorted, our heads shaved and no liberty for twenty-one days. We have been drilling every day from 7:30 to 11:30—1:30 to 4. The rations are excellent; a fine crowd of boys and all ready for the lot they are assigned. Certainly feel fine and can say that it will be a fine training, both mentally and physically."



How the Boys Look On a Transport Crossing the Atlantic. F. R. Lack, of the New York House, is the Man Without a Hat, Designated By a Cross

Godspeed

Out where the Stars and Stripes are flying,
 Out where the brave and staunch are dying,
 Out where for freedom, death defying,
 Our soldiers take the lead.
 Thither to fall, tho conquered never,
 Thither to plant this truth forever!
 Liberty's arms no foe can sever!
 Thither, my friend, Godspeed!

I. O. A., Chicago.

Richmond contributes, this month, a photograph of F. P. Thornton. He enlisted in the Navy as an electrician, first-class, last July, but was not ordered to report for duty until November. At present he has charge of an electrical storehouse at an Atlantic port, and has to attend to the electrical wants of a fleet of about forty submarine patrol boats.



F. P. Thornton, U. S. Navy

A letter written to his former associates at Richmond tells an interesting story of a narrow escape from failure to get on the payroll.

Ensign William J. McGibbon, who was employed in the foreign department at Hawthorne up to last June, is now on the U. S. S. *Ohio*, and mail for him should be sent to that ship in care of the Postmaster at New York. Ensign McGibbon writes to the News to assure the editors that the News is greatly appreciated by the Western Electric men in military and naval service. He expresses the wish that he could write something of his own doings, but rightly surmises that the censor would soon put a stop to that.

W. H. Mikkelson, who left the general purchasing department at New York to join the Navy, has just been made Assistant Head Storeman at the Portsmouth, Va., Navy Yard and has charge of all of the supply buildings with the exception of three which are used for supplies which are out of his line. He was chosen for the position from a list of fifty storekeepers and attributes his promotion to what he terms his "Western Electric schooling."

W. M. Goodrich, who for some time has been the Chicago correspondent of the News, has enlisted in the Aviation Corps, and when last heard from expected to be called for active service about the time that this issue of the News goes to press. He was one of five men selected out of a group of thirty-six candidates.

E. M. Druery and John Emmerling are two other boys from the Chicago house who enlisted recently. Both joined the Ordnance Department and were sent to Cleveland.



Lieut. Phil. Cook: Dallas Claims that He is the Handsomest Man in the Western Electric Organization

The picture at the left will substantiate the claims of Dallas that Phil Cook was the best looking man in the entire W. E. organization. The reader may judge for himself the number of hearts that were broken when he joined the colors.

Lieutenant P. P. Cook originally joined as an instructor in the aviation section, and for some time was Adjutant of the Ground School. He is now in the flying school at San Antonio and has been flying since about December 1. Mr. Cook came to the Dallas house as a student from the

University of Texas and was in the Sales Department at the time he left.

Eric M. Unmack writes to his friends at the San Francisco house from Angel Island, Cal. He first thanks his former fellow workers for the Christmas box which he received. Not long after he wrote he was sent all the way across the continent and is now a member of Company A, 24th Engineers, stationed at Camp Dix, Wrightstown, N. J.

"As you all are probably aware there were reasons which made me consider very seriously whether it would be the American Army I would enter or the Canadian. After due consideration and to cut a long story short I decided that a country worth living in is worth fighting for and I am proud and pleased, and in no way regret that I am now a duly 'sworn-in' soldier of the United States of America, fighting for my adopted country, and the Allies' great cause, for freedom.

"So far I have not encountered a single thing which I have not more or less expected to be my lot some time or other, and particularly at this time. Eats are plain enough, but there are plenty of them, and though the meals get monotonous they are nourishing. Cups are like washtubs, plates are made of 66,000-volt high-tension insulators, bread is served in lumps in office desk baskets (wire) and we only have butter at breakfast, but such things I fully anticipated more or less before I ever knew. In fact, I fully expected meals to be served to us in a tin pan and a tin mug and this part, at least, was a pleasant surprise to me.

The photograph to the right represents the temporary demise of Private Charles L. Heisner, formerly with the Service Department of the San Francisco house, at present of the 15th Infantry at Camp Kearny, and soon to be located "Somewhere in France." Private Heisner says that he puts in about eight hours a day at this exercise, and has gained fifteen pounds on it.

Arthur Carey, who was employed in the Boston shop up to April 23, 1917, worked on a forty-line switchboard during the month of March, 1917. This switchboard was a rush order for the United States Government. Mr. Carey on April 23 joined the Sixth Hospital Unit of the Massachusetts General Hospital of Boston. This unit sailed for France sometime in May or June.

On his arrival in France, he was put at work opening cases, and much to his surprise, he opened a case which contained the switchboard on which he worked while in the Boston shop. This unusual occurrence was such a surprise to him that he immediately sent back to a fellow-worker the shipping ticket—No. 20180. He also says in one of his letters that this switchboard was the means of obtaining a position for him in connection with telephone service. He now has charge of all switchboards and installation in one of the hospitals.

Lieut. P. H. Olsen, of the Dallas House, who is now at Camp Travis, Texas, thought a month or two ago that the National Army recruits were a pretty listless lot. That he has changed his opinion and is not ashamed to admit that he was in the wrong is revealed by what he says in a letter written to R. W. Van Valkenburgh:

"Our work here is becoming more interesting every day as our men improve and take more interest in the work. The company and regimental spirit has now become very noticeable and one can readily see the great difference in the life and work of our men. Men who apparently had never played before in their lives are beginning to take interest in some of the games, and it can truly be said of some that they have risen from the dead. You would scarcely believe that some of these men, who now romp about like four-year-olds, were the listless, don't-give-a-damn, worthless-looking lot that I described in a previous letter. Men, whom we considered useless, have gradually developed into reliable non-coms and others have surprised us in many ways. Here, indeed, "Looks are deceitful." In fact, so surprisingly deceitful have they been that we have begun to give every man every chance to show what he can do.

"We are all eager to go over and help along in the good work, and yet I think all of us realize what is yet necessary to make of us an efficient engineer unit. There is no telling when we may leave, but we shall welcome the day when it comes."





W. E. Mougey

W. E. Mougey was a member of the Hawthorne Radio Company until last October, when he was detached from that organization and sent to France. His present rank is Master Signal Electrician, which is about the highest paid non-commissioned rating in the entire United States Army. While at Hawthorne he was a cable development engineer. His fellow members of the Radio Company were sorry to lose him, but glad that he had been selected for such important work.

G. A. Morency and Frank Barth, also members of Hawthorne's signal corps company at Camp Funston, Kans., were ordered to overseas duty and started for France early in December.

The letter which follows is printed almost in full because it shows how even the discomforts of Army life soon are forgotten by the man who has the right sort of stuff in him. R. J. Silcock, one of the boys from the Engineering Department at West Street, is the writer.

"I am sorry to have kept you waiting this long, but have been on the jump and moving about all the time. I am now at Camp Johnston and am having a wonderful time.

"My first week was not very pleasant but life shouldn't be all sunshine. December 7th we were sent to Fort Slocum and remained there until the following Wednesday. We did not have uniforms and I, like many others, went 'light,' not expecting to stay in civilian clothes longer than a day. We were all greatly disappointed as well as displeased but it couldn't be different. Saturday night we stood in line in all that wind and rain till 11:30, and then we were put in cold barracks. It is no use saying that we did not sleep as that was impossible. But when we think of the muddy trenches we realize that we were not so bad off.

"Florida appeals to me very strongly and it seems like living to be here. I would rather be a private in Florida than a Captain at Slocum. We arrived here Saturday morning by train of nineteen cars. The sun was shining and it seemed like heaven to shed the coats and roll up the sleeves. Monday and to-day have been a bit cloudy and cool, but when I look at a paper and see that New York traffic is tied up with snow it takes the chill off.

"I often think of the boys and girls of Departments 672 and 675, and though the first three days in army life made me regret I had ever left my happy home, now that I have gotten a good start you couldn't pull me out."

From France comes a letter bearing on the envelope the censorship stamp of the American Expeditionary Force, and within some purple splotches blotting out words which did not get by. The writer is Corporal A. Jackson of the Headquarters Company, 6th Field Artillery, and before his enlistment he was employed at the Omaha house. Some excerpts from his letter follow:

"In going over THE NEWS I read where I, Albert Jackson, belong to the National Guard. I wish you would make a correction, for I am a Regular and proud of it. We are all very happy and make the best out of everything. We had a wonderful dinner for Thanksgiving, and I don't think that any of the soldiers in the camps in America had anything on the boys in France."

When the famous old 71st New York Regiment was transferred into the 54th Pioneer Infantry, U. S. A., a change which took place down at Camp Wadsworth, among the men whose status was altered was First Sergeant Edward W. Boise, of Company B, a Western Electric man from West Street. At first he was none too well pleased but later he heard that the new outfit was likely to get to France long before the 27th Division to which the 71st had belonged, and his sorrow turned to joy.

According to Sergeant Boise, life at Spartanburg, even with the 54th Pioneers, isn't always quite as comfortable as working for the Western Electric Company. Here is his description of the cold wave which hit the South last month:

"Our camp is situated about four miles from Spartanburg. Although it has a population of 30,000 inhabitants it reminds one of the smaller cities in the State of New York. Spartanburg has been under about eight inches of snow, and we are told by the people living here that it was the heaviest fall of snow that they have had in ten years. After the snow a cold wave hit the camp, sending the mercury down to five degrees below zero, then our drill consisted of wood chopping—that is if you are lucky enough to get any wood.

"The condition of the weather has been the cause of many verbal battles as to who is to get up in the morning and light the fire so that the rest of the men can dress in comfort when reveille sounds. When you consider that reveille sounds at 6 A. M. you can readily imagine the intensity of those battles. It seems that no one wants to get up at 5.30 in the freezing cold to warm up the tent for the rest of the squad, and hence the quarrels."

Just to prove that the News is read by the soldiers, the accompanying picture is printed. They are Louis Sorrow and J. Haney, both former employees of the Company, who now are at Camp Gordon near Atlanta, Ga. Mr. Sorrow, who sent the picture, was drafted at Bridgeport, Conn., and sent to Camp Devens at Ayer, Mass. When they found that he was a Western Electric man he was transferred to Camp Gordon as a member of the outpost company of the 307th Field Signal Battalion. "We have a good captain, I think he is a telephone man," is the way he describes his commanding officer.



Louis Sorrow and J. Haney Reading THE NEWS at Camp Gordon



James Malone and Some French Scenery

The soldier on the left is James Malone, who has been in France as a member of the No. 1 General Hospital. This is the unit from New York which also included Dr. R. V. Grace and the Misses Rignel and Evans. In a portion of his letter, which has been omitted, he says that Miss Evans has been compelled to give up her work close to the front and has gone to a hospital in the South of France where she is continuing her nursing. The weather in Flanders was too severe for her.

Although he admits that he is not an expert and that he probably doesn't know any more about when the war is going to end than his friends in New York, Mr. Malone's views on that subject are most interesting. Parts of his letter follow:

"I received your card and also the Christmas package which my co-workers at dear old 468 sent to me. I want to thank them all through you for their kindness in remembering one of their number far away from home and civilization. It certainly brought great joy to me when I read the label and saw where it had come from.

"Your card caused somewhat of a sensation among the boys here. It was the first time any of us had seen the new service flag. It sure did look good flying from the front of the building. I put the picture on our bulletin board and it has drawn quite an audience since I posted it, especially among the British soldiers here. I have to keep my eye on it; otherwise some one of them will take it as a souvenir. The Tommies, as we call them, are great souvenir collectors. Some of them carry half of the battle-field in their kits.

"The American Y. M. C. A. has built a hut for us and it is a very nice and cozy place these cold nights. I installed the lighting system, which consisted of a small gasoline engine with a 110-volt dynamo attached to it. We have forty-two lamps in the building on an amperage of twenty-five. The lamps range from ten to twenty-five candlepower and light the building up in great style. There are heavy curtains on the windows so that no light shows on the outside. You know the reason for that precaution.

"Most of the letters that I have been receiving of late ask my opinion regarding the war. Most people have an idea that on account of our being so near it all, we can tell when it is going to end, when, as a matter of fact, the people in the States get more news that we do, judging from the New York newspapers. I do not think that the war is going to last over next summer, as the German soldiers are starting to rebel in the trenches and are being shot down by their own officers. There is also a revolution starting inside of Germany among the people. Most all of the prisoners that we get tell us that they are fed up with it, that a great saying among soldiers who have been in the line for some time is that in order to get food they have to keep attacking the Allies for so many hours, so you can see for yourself what keeps the war going on. It is only a matter of a short time when they won't have any food to spur their soldiers on. The Allies have taken more prisoners in the past few months that they had in a year previous."

Last summer A. P. Peterson left the chemical research department at Hawthorne to enter the first officers' training camp at Fort Sheridan, where he secured a second lieutenant's commission. Recently Hawthorne friends received a letter written by him from France. Lieut. Peterson says:



Lieut. A. P. Peterson

"I got over here without events of any interest and with some thirty others was sent to a British army school, where they send their junior officers at regular intervals to put them in touch with the latest developments and sort of 'pep' them up a bit. Their system of instruction agrees with me; work a couple of hours a day, listen to a lecture by a real General and play the rest of the time. They are strong for football, boxing (I won the welterweight championship), cross-country running and that sort of stuff. Wish our army would copy them.

"After five weeks of this I spent one week with them in the trenches; saw two British raids go over and got jammed in a small German night raid on us. 'We' beat them back, however, and were left with a couple of Germans on 'our' hands, on whom I practiced my German. They had to stand for it.

"You would enjoy rambling around this country—all hills and valleys, woods, streams and that sort of thing; quite a bit of game, too, such as a few pheasants, plenty of rabbits and wild boars. I made a raid, with four soldiers, on what was supposed to be one of their strongholds, but owing to a very violent form of 'vin blanc' having been smuggled into their canteens, our campaign sort of fizzled out, and as an army order has been issued against hunting, we won't get another chance at them. Swimming in the canal has also been prohibited.

"There is an old Roman camp near here, dating from Caesar's time, probably built as a base of operations against an ancient tribe known as the Germans. The ramparts are very well defined, and the location is excellent. The old Roman who built it could march a couple of legions in there most any night, post his centurions on guard and feel perfectly safe from any enemy he ever knew. His ghost would probably be greatly surprised in case it looked over the hill into the valley below and saw a battalion of our boys training against the same enemy. I have seen no likely looking place to dig for corpses (not in my line, anyway), but there is an old Frenchman in the village who digs around up here and always finds Roman coins. I think he has a supply of them cached away somewhere, as he is always suspiciously successful, so haven't asked him to dig for me.

"I expect to get a short Paris leave in a few days. My French is rotten. I have made practically no progress in the language, as our business with the French authorities is taken care of by interpreters and there is practically no spare time. Censoring mail and studying new methods of warfare take up the evenings; drill or manoeuvres all day."



Lieut. Irving Folks

Lieutenant Irving Folks, formerly of the Foreign Sales Department, has recently received his commission as Second Lieutenant of Infantry in the Regular Army. Lieutenant Folks attended the first Plattsburg camp, beginning in May, 1917, at the end of which he was recommended for further training at the second Plattsburg camp, which began in August. At the end of the second camp he received his commission. Lieutenant Folks deserves great credit for the persistence with which he followed his military training and his commission in the Regular Army is the reward of his efforts.



V. S. Perkins, On a Monument

V. S. Perkins, of the Richmond house, is now in the Army as a member of the Richmond Howitzers which when last heard from were stationed at Fort Oglethorpe, Ga. Among other things he says:

"Until about thirty days ago we had a very easy time, but since then we have been drilling hard every day through snow and cold weather. At times it gets pretty hard, and then I just start thinking of this time last year when I was sitting down at a desk all day instead of firing a three-inch gun on a range.

"After all the hardships a soldier in the artillery has, he also has a lot of good experiences that will be appreciated after it is all over and we are back home again."

Thanks for Christmas gifts can be found in most of the letters from soldiers which the News has received this month. Three former employees of the New York house, George D. Hasbrouck, David D. Haggerty and George I. Blanchard, joined in writing a letter to the Editor, asking him to thank their co-workers at West Street for the Christmas gifts sent to them. They are members of the Division of Research and Inspection of the Signal Corps and are stationed at Fort Wood, N. Y.



Capt. Jack Sheriff

Capt Jack Sheriff, of Company B, 824th Field Signal Battalion, stationed at Camp Meade, Maryland, is one of the host of Western Electric men in military service who lost no time in expressing his appreciation of his Christmas Box from his former fellow workers. In fact, the following letter to the Cincinnati house, which proudly claims him, was written just a week before Christmas:

"It was with extreme pleasure that I received your letter of the 15th, and the box of goodies to-day, and I want to thank you all separately and collectively for the kind thoughts expressed in your letter and the bully gifts sent me. One thing that a soldier looks forward

to is much mail, and especially when that mail comes from those whom he has been connected with and grown attached to in four years of service.

"We are becoming gradually snowed in and under here at Camp Meade, and although it is rather difficult to perform our section and technical drills in the snow, still we are managing to beat the elements to it.

"I certainly would appreciate hearing from you all as I am Cincinnati and Western Electric Company hungry."

Here is H. P. Ryan, once household device specialist at the St. Louis house, now a U. S. Marine in training at Quantico, Virginia. Private Ryan has made an enviable record since joining the "first to fight" boys and writes that he is greatly pleased with life in the Marine Corps. He has proved as proficient in handling the rifle as he was handling sales campaigns, and has qualified as an expert on the Rifle Range.



H. P. Ryan, U. S. Marine Corps

One of the West Street men who went to France as a member of the Research and Inspection Division, Sergeant Paul A. Jeanne, has this to say of his life on the other side of the Atlantic:

"I find myself sadly deficient in French—for instance, in the restaurant a few days ago I undertook to order butter for four or five of us. I asked for beurre (butter) and got bierre (beer)."

As the caption says, the central figure in the accompanying photograph is Major John A. Kick, formerly in general sales work at New York. The News told its readers last month something about his battalion of the Signal Corps at Camp Lewis, American Lake, Wash. In the photograph he is busy describing a proposed construction job. Just how busy Major Kick is may be gleaned by reading of a short extract from one of his letters:

"Have only been out of Camp a few hours since arriving here, October 20th, as I find the hours too few to be spared, although I would like very much to visit the Seattle House."



Officers of the 405th Tel. Batt., Signal Corps, N. A., Camp Lewis, Wash. (from left to right): 1. First Lieut. E. M. Brown, Co. E, Emp. Tel. Dept., Santa Fe Ry., Newton, Kansas. 2. First Lieut. Wm. E. Liggett, Batt. Adjt., Emp. Mountain States Tel. & Tel. Co., Denver, Colorado. 3. Captain Edward W. Sloan, Commanding Co. E, Emp. Western Union Tel. Co., Minneapolis, Minnesota. 4. Major John A. Kick, Commanding Batt. Emp. Western Electric Co., New York City, N. Y. 5. Captain Alex. W. Young, Commanding Co. D, Emp. Mountain States, Tel. & Tel. Co., Denver, Colorado. 6. First Lieut. Edgar C. Fisher, Co. E, Emp. Western Union Tel. Co., San Francisco, California. 7. First Lieut. E. R. Hannibal, Co. D, Emp. Mountain States Tel. & Tel. Co., Denver, Colorado. 8. First Lieut. C. F. Kunsemiller, Batt. Sup. Officer, Emp. Mountain States Tel. & Tel. Co., Denver, Col.



A Christmas Box From Hawthorne Reaches Private Frank Daniels, 108th U. S. Engineers, at Camp Logan, Texas



Atlanta's Delegation at Camp Jackson Lined Up With Their Christmas Boxes; Before they Opened Them they Insisted on Getting their Picture Taken to Send Back Home. Those in the Photograph are (from left to right) Messrs. Whitmire Lowery, Hix, Stepp, Weaver

Hawthorne Soldiers' and Sailors' Comfort Club Gets Under Way



NCE in a while even an exuberant reporter guesses too low. At the time the January News went to press the estimated membership of the Soldiers' and Sailors' Comfort Club at the Works was 15,000. Later returns brought the figures up 3,000 higher, which means that over seventy-eight per cent. of all the workers at Hawthorne got together at the first general opportunity to do something for the comfort of our boys who are with the colors.

One of the early steps in getting the movement under way was writing letters to the men whose addresses could be obtained, asking them to list articles that would add to their comfort. Much of the necessary correspondence was turned over to the Hawthorne girls, under the not unreasonable assumption that a soldier or sailor finds a letter none the less interesting because it bears a feminine signature. This has led in many cases to the friendly exchange of letters which the club officers had hoped to establish.

The membership dues are only ten cents a month. Therefore, since Western Electric men in war service number over 2,500, even one hundred per cent. membership in the club (about 23,000 members) would supply somewhat less than one dollar per month for each man. For this reason requests for personal articles of considerable cost will be turned over to the departments in which the men worked, where their immediate friends will, of course, be glad to take care of the request. Knitted articles will be made by the women's subcommittee which was already organized for Red Cross work before the Soldiers' and Sailors' Comfort Club was started.

The women have already done much good work in relieving war suffering and expect to continue this work

in addition to their work for the Western boys. They have finished sixty-eight babies' petticoats, seventy-five babies' kimonos and twenty-seven women's nightgowns for the American Fund for French wounded; eighty-three sweaters and forty-two pairs of sox for the Red Cross, besides three helmets and one trench cap for our own boys.

Many letters of appreciation were received from the men to whom Christmas boxes were sent. Private Frank Daniels, Company C, 108th Engineers, at Camp Logan, Texas, formerly of the Hawthorne millwrights, sent in a picture of himself with one of the boxes, "taken," he writes, "while the boys stood around and envied me." But, he adds later, "they all had their share of the contents and appreciated it very much." Sergeant F. A. Thielen, formerly of department 6109, answered in verse. But whether in poetry or in prose, all the letters have the hearty ring that lets us feel we have already accomplished something.

What the Chicago House Did



The Northern Lights

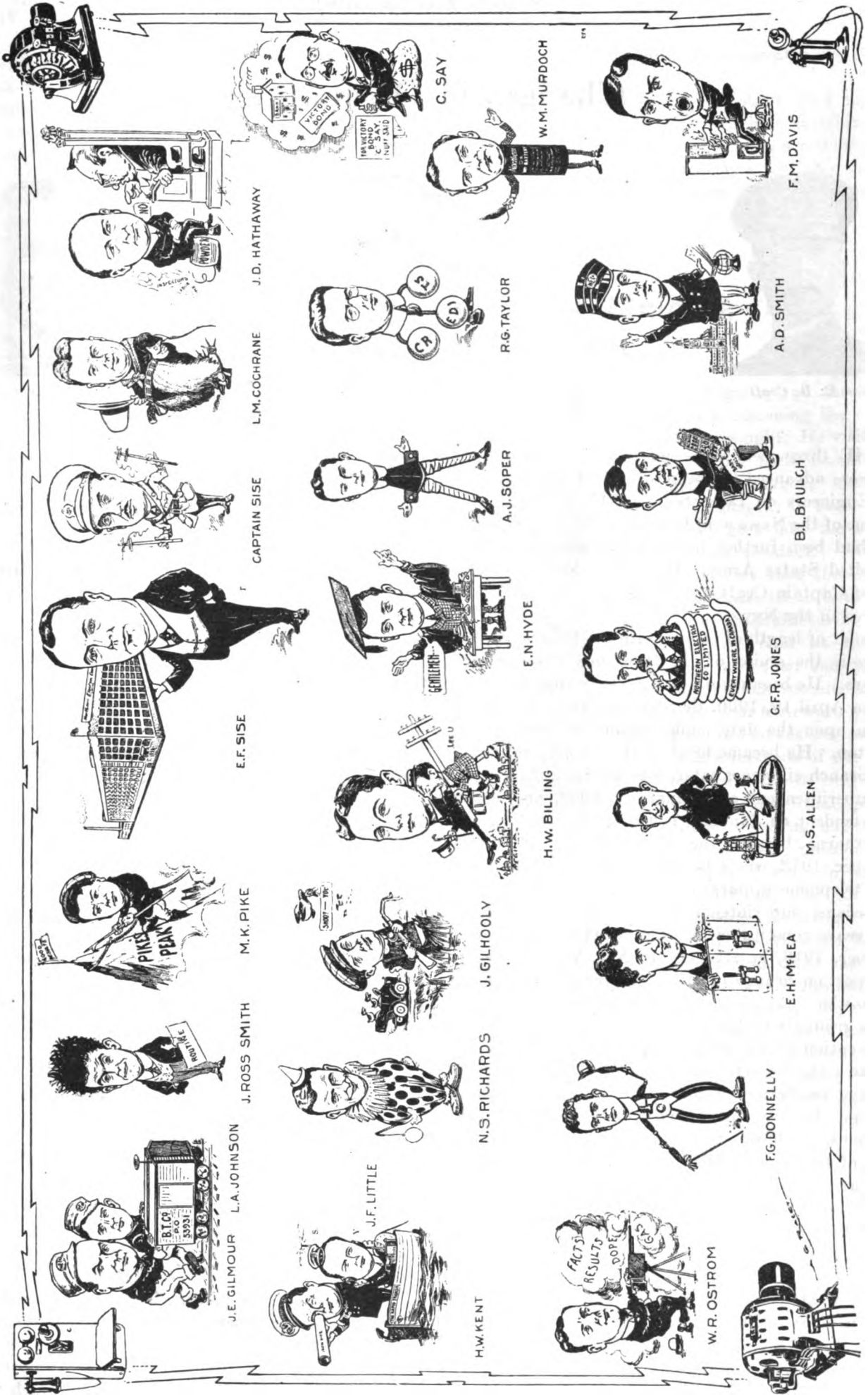

Prominent Personages of the Northern Electric Company, Our Allied House in Canada, as Portrayed by a Cartoonist on the Menu Card of a Recent Dinner at the Montreal Hunt Club

Changes in Organization



Major E. B. Craft



W. F. Hendry



E. H. Colpitts

THE three men whose photographs appear above were advanced to the positions of Assistant Chief Engineers on December 1, 1917, and just before this issue of the News went to press word came that E. B. Craft had been further honored by being promoted in the United States Army. He is now Major Craft instead of Captain Craft as he was when his picture last appeared in the News.

In point of length of service with the Company, W. F. Hendry is the senior of the three new assistant chief engineers. He began work as a factory engineer in New York on April 19, 1900, thereby conferring further distinction upon the date made famous by the Battle of Lexington. He became head of the service and maintenance branch six years later, was advanced to assistant shop superintendent on January 1, 1909, and to shop superintendent on January 1, 1911.

Hawthorne became the scene of his activities in September, 1913, where he was assistant superintendent of the telephone apparatus shop for a short time and then became superintendent of the technical branch. Three years constituted his term at Hawthorne, and in November, 1916, he returned to New York as head of the inspection branch of the engineering department, a position which he held until made assistant chief engineer. He is a graduate of Cornell.

No mention of Mr. Hendry in these columns would be complete without a reference to the fact that since the beginning he has been a member of the Board of Editors of the News. He has made many valuable contributions to its columns, in addition to his work as one of the associate editors of the News. His contributions have appeared under various noms de plume, and as far as his editorial work is concerned, the numerous correspondents are assured that any of their contributions which pass his acid test are worthy to take their place on the list of Western Electric Quality Products.

Major Craft is an Ohio product, having been born in the town of Warren in that State. His birthplace is in the center of the district where the incandescent lamp was developed, and at the early age of sixteen he began work in that business. In his spare hours he continued

studying physics and chemistry under the direction of one of his high school teachers, and after four years of that sort of work decided that he wanted to enter the telephone business.

He packed up his things and advanced upon Chicago and the Western Electric Company. His request for a job was granted and he went to work in the development division of the engineering department. There he stayed for five years, coming to New York as head of the development branch in 1907. He remained in that position until his recent promotion.

It isn't entirely because of his engineering ability that Major Craft received a commission in the United States Army. He was one of the preparedness advocates who practised what they preached by going to Plattsburg long before this country entered the war.

As an inventor Major Craft has gained an enviable reputation. He lives in Hackensack, N. J.

E. H. Colpitts is a Canadian, having been born at Pointe de Butte, New Brunswick. He attended Mt. Allison College at Sackville, New Brunswick, from 1888 to 1893 and later went to Harvard where he spent three and one-half years. For two years he was an assistant instructor at Harvard and during that period began work with the A. T. & T. Co. in Boston. He remained with that company until 1907 when he transferred his activities to the Western Electric Company, becoming head of the physical laboratory in New York. He was advanced to the position of head of the research branch.

The work which the three new assistant chief engineers will do is divided about as follows: Mr. Hendry has general charge of the production and service activities of the engineering department in New York. The model shop, the manufacture of vacuum tubes and the new job shop all come under his supervision, and in addition he has charge of the maintenance and operation of the West Street plant. The clerical, medical and employment departments at West Street also are managed by him.

Major Craft will devote most of his time to supervising the various Government contracts which the com-

pany is working on at West Street. He also will be engaged in the development and design of circuits for manual switchboards and sub-station apparatus. Wireless work and telegraph studies also are in his province.

Mr. Colpitts handles the research work in both the physical and chemical laboratories. The physical and chemical properties of the various materials used in the

manufacture of Western Electric apparatus are studied by his department.

J. L. McQuarrie remains as assistant chief engineer with his office at West Street. Machine switching, the telegraph printer and lead-covered cables are three of the things to which he devotes especial attention. A good deal of engineering inspection work also falls to his lot.



Western Electric Men Who Are Helping the Government—J. M. Stahr

WHEN the Government first borrowed J. M. Stahr from the Company some time last summer, it was stipulated in the bond that he must be returned in good working order at the expiration of three months. When the time was up, however, the Government officials asked for three months more of Mr. Stahr's services, and these being war times when everyone's first duty is to do what he can to help gain the victory, the Government got what it asked for.

All of which proves that Mr. Stahr's work has been appreciated in official circles. Now for a word or two about the work itself. He is attached to the equipment division of the Signal Corps which does the purchasing for, that branch of the United States Army. Most of this purchasing is done on what is known as the "cost-plus" basis; that is, the Government pays the cost of the articles it buys plus an agreed percentage of profit.

Needless to say the Government has to keep a check on the cost of the things it gets in this way, some of which are little articles like aeroplanes and that is where Mr. Stahr comes in. At Hawthorne he was in the accounting division of the manufacturing department, and so lived in an atmosphere of manufacturing costs.

His work with the Government consists in assisting



J. M. Stahr

Major Langmuir, of the Signal Corps, in determining the cost of the articles bought. He visits factories, studies their manufacturing methods, labor, materials, overhead charges; in fact, everything that goes into the cost of the finished product. One important matter that the Government has to attend to is to see to it that these manufacturing establishments are paid at the time when they need their money in order to keep things running smoothly and turn out their work promptly. He also makes comparisons between the methods of the different factories he visits.

One thing more that perhaps is a little boastful but is too good to be left untold. Mr. Stahr reports that in all the

course of his Government work he has found no manufacturing establishment using a better method of cost accounting than that of the Western Electric Company, and that he has found no other method in use that has not at some time been considered and rejected by the Company's accounting department. Furthermore, at least one nationally known manufacturer who has seen the Western Electric methods of cost accounting applied to its Government work by Mr. Stahr, has decided that in the future it will adopt the Company's methods for all of its private work as well as that done for the nation.

New York House to Move to Fifth Avenue

On or about February 15 the offices of the New York Distributing House will be removed to the Broadway-Fifth Avenue Building, located at No. 151 Fifth Avenue, New York City. We will occupy the four upper floors of the building, which is a new fire-proof structure, sixteen stories in height, with entrances on Fifth Avenue, Broadway and Twenty-first Street. Approximately 34,000

square feet of net floor space will be available at the new quarters, but even that area will be none too large.

A more nearly complete description of the new offices will appear in a subsequent number of the NEWS, together with photographs which will be taken after the move has been completed and the organization is at home in its new quarters.



To Be Awarded in February

TWENTY-FIVE YEARS

Schaul, Conrad, New York.....	February 16
Dean, H. G., Hawthorne.....	" 16

FIFTEEN YEARS

Kilcoyne, Jessie, Chicago.....	February 24
Johnson, C., Hawthorne, 6825.....	" 7
Cloutier, J., Hawthorne, 5757.....	" 10
Brahm, H., Hawthorne, 6801.....	" 16

Howe, L. W., Hawthorne, 7397.....	February 16
Johnson, E. J., Hawthorne, 5756.....	" 16
Soukup, F., Hawthorne, 6301.....	" 27
Thomson, P. L., New York.....	" 23

TEN YEARS

Gathright, W. E., Atlanta.....	" 17
Seckler, C., Hawthorne, 6346.....	" 12
Lillis, L. S. S., Hawthorne, 5921.....	" 12
Wright, G. E., New York.....	" 18

F. J. Holdsworth



F. J. Holdsworth's ability to pick stars has made the Hawthorne ball team known from hence to yon and all intermediate stops, so it is no surprise to learn that he has just collected another star for his service button—until you notice, it is his third,

which is certainly going some for a youngster.

But then, Fred started young. He began as a messenger boy at Clinton street when he was no bigger than a dollar's worth of potatoes (present prices). Like the potatoes, he had eyes, and he kept them peeled, too. Soon they saw an opening for him as office boy to the general manager. Still they kept on looking, and he landed a place in the retail store, then in the supply sales department, next in the cable plant as clerk. When the cable plant was transferred to Polk street he was put in charge of shipping and receiving. From this job he went to Hawthorne as shipping clerk under Superintendent Darlington, Hawthorne's first superintendent. His present position is warehouse manager, in which capacity he has charge of storing and shipping the total output of the Hawthorne works.

In between times Fred acts as chairman of the athletic committee. He classes as one of the best baseball scouts in Chicago. Or, if you are not interested in baseball, leave that out of the statement and it goes just the same.

H. G. Dean

Back in '93 the Clinton street shops hired a young Englishman as a toolmaker. He must have made good, for he was still in the tool room in April, 1902. But May is another month again and another month meant another job, this time in the tool drafting department.

Four years of that experience landed him on the job of assistant factory engineer. A little later the "assistant" was dropped from the title. Shortly after he was transferred to Hawthorne, where he now wears three titles, one for each star on his service button. They are: Head of the plant inspection, head of the plant maintenance division, and chairman of the music committee.

After that of course there is no need to mention H. G. Dean's name. Hold on, though! One of Bert's titles came near escaping. He is also an ex-president of the Hawthorne Club. There may be more, but that's all we remember just now.

Conrad Schaul



Conrad Schaul admits that he was exceedingly glad to get a job with the Western Electric Company on February 16, 1898, because just at that time the panic of '98 was doing its best to disarrange the industrial and financial world. Jobs were scarce as a result, so when Mr. Schaul found an opening at the old Thames Street shop in New York he jumped right in and closed the door after him.

He began work as a model maker and has stuck to that sort of work ever since. For about fifteen years he was head of Department 416, but when that department was moved to Hawthorne he returned to his old corner in the model room.

In all the twenty-five years of his service with the Company, Mr. Schaul has missed his daily work only on one occasion, and that was when he was ill. He lives in Brooklyn with his family. One thing more, Mr. Schaul's name may sound a trifle Teutonic, but names are not everything. He is a Swiss and the Kaiser is not on his list of friends.

The Fifteen Year Squad



P. L. Thomson



L. W. Howe



Miss Jessie Kilcoyne



H. Brahm



E. U. Taylor

War Savings Stamps

IN order that employees of the Company may buy War Savings Stamps without difficulty, stations at which stamps may be purchased have been established at numerous points in the various departments. A trip to the post-office or bank no longer will be necessary. Each employee will find a place where he can get the stamps not far from the scene of his daily work.

It is hardly necessary to say that these stamps are an excellent investment, as well as aids to the Government in its great task of prosecuting the war to a successful conclusion. If purchased during the current month, \$4.13 worth of stamps will be bought back by the Government on January 1, 1923, for \$5.00. After February 28 it will take \$4.14 to get \$5.00 worth and the price will go up one cent each month. The moral is: "Buy Now."

But even if you can not buy now, it will not take long to save up a quarter, for that is all that is needed to make a start. The twenty-five-cent stamps may be

pasted in a savings book until sixteen of them, or \$4.00 worth, have been accumulated, when by paying the sum of thirteen cents a \$5.00 certificate may be obtained. It's exactly as easy as it sounds.

In New York City a special committee has been formed to help the electrical industry do its full share in the thrift campaign. Vice-President Halligan is chairman of this committee. Part of a letter which he has written to the electrical interests in New York City follows:

Buy a **\$4.13 W.S.S.**
 The Government Buys it Back from You
 January 1st. 1923 for **\$5.00**

"The Government has asked every industry represented in Greater New York to lend its support to the War Savings Stamp plan. This plan has been adopted for the purpose of enabling anyone to buy thrift stamps. These thrift stamps in denominations of twenty-five cents each are convertible into War Savings Certificates valued at \$5 each, which, in turn, may be redeemed in accordance with the terms of the attached circular. This enables every man and woman in the electrical industry to aid our country and to share in carrying on the war.

"The Government's method of procedure is to sell these thrift stamps through appointed agents. The National War Savings Committee desires to have as many agencies as possible established in the electrical industry, and your Company is invited to take such an agency as a means of stimulating patriotism and the habit of saving among your employees. For these reasons we feel sure that we can count on your whole-hearted support."

Western Electric Man Writes Book on Wireless

John Mills, of the research branch in New York, is the author of a book entitled "Radio Communication," published recently by the McGraw-Hill Publishing Co. The book contains an explanation of the various methods of radio communication and an appendix which deals with transmission over wires. The price of this book is \$1.31.

Mr. Mills was an engineer of the A. T. & T. Company for about five years before coming to the Western Electric Company in 1915.

Married

January 2nd.—Miss Ester Newberg, Department 6345, Hawthorne, to A. Schmidt.

January 12th.—Laddie Eiselt, of Department 6031, Hawthorne, to Miss Bessie Brycht.

Date unknown—M. T. O'Donoghue, formerly of the New York House and 175 Broadway, now in the Army, to Miss K. E. Murray, head of the record room at West Street.

Results of New Customers and New Business Contest for November, 1917

THE salesman securing the largest number of new customers during November was:

J. Sorensen, Seattle.

The salesmen securing the highest number of points or sales to new customers for the period ending November 30th were:

E. H. Waddington, St. Louis, 1237 points.

E. K. Brackett, New York, 678 points.

H. B. Stanton, Atlanta, 484.

Hawthorne Digs Itself Out

Worst Blizzard in Years Hits Chicago, But Fails to Beat the Works Service Department

SOMEHOW whenever these old women try to bolster up their fading beauty with cosmetics they always overdo it. Take the case of old Dame Nature, who resides here and hereabouts. One Sunday recently (January 6, to be legally accurate) she got out her powder puff and began to decorate. At first the effect was rather becoming, but of course she had to spoil it by lack of decent moderation. Moreover, she began to breathe so hard from the exertion that she collected the powder in heaps, when, as everyone knows, complexion should be applied smoothly. To cap the climax, seeing the damage she was doing, she fell into a womanly panic and proceeded to make matters worse by showering on more and more of the white in the hopes of getting herself out of the difficulty.

After that there was but one possible thing to be done.



—everybody had to turn in and help the old lady clean off her face. The service department at Hawthorne, old experienced hands at the job, started in early. By noon Sunday eighty-five men and eight teams were at work clearing paths through the principal roads and sidewalks of the grounds.

Meanwhile more snow fell and more wind blew. Once in a while a street car ran. Twice in a while it did not. Belated citizens watched and waited on the street corners, while nothing passed but time. It looked bad for the chances of getting to work on Monday.

It looked worse when Monday morning came, although the snow had ceased. At 6:30 Officer J. O'Brien swung open Gate 26 and looked out on Ogden Avenue. Nothing but snow—a pile of it had drifted clear up to the top of the fence. Ho hum! Indications were that traffic



Officer J. O'Brien and Miss Mary Wilson, Dept. 7392 (left). Miss Martha Henderson (right) Whom he Rescued from a Drift Near the Ogden Avenue Gate. The White Patch on the Fence Shows the Height of the Drift



Twenty-second Street Looking Toward T. A. Building. Somewhere in the Drift to the Right is a Motor Truck Completely Buried



A Trench Through One of the Drifts on Ogden Avenue



Excavating Hawthorne

would not be very heavy at that gate. Hold on, though. That sounds like a muffled feminine squeal. Or is it two squeals? It is. John immediately plunges into the drift and comes out with two stranded girls. His day's work has begun.

The girls were Miss Mary Watson, of department 7392, and Miss Martha Henderson, of department 6886, who had started to work early to beat out the weather man. It takes more than the worst snow storm in fifty odd years to make these girls late!

Usually the Works gates do not open until 7 o'clock, but they all opened at 6:30 Monday, so that employees starting early because of the storm should not have to wait outside. About 500 arrived between 6:30 and 7.

By that time paths had been re-cleared, enlarged and extended throughout the Hawthorne grounds, thanks to the labor of about one hundred and eighty-five men, who had been hard at work since 4 A. M. At 8 o'clock sev-

eral of the principal drives were open for truck traffic.

Most of the snow had to be disposed of by shoveling it into the sewers and washing it away with water supplied through fire hose. During ordinary storms most of the snow is dumped on vacant ground throughout the Works, but the heavy drifts cut off the dumping grounds this time and made that method of disposal impossible.

Two snow plows were kept busy from Sunday noon until Monday night. By this time the embankments at the sides of the cleared spaces were so high that the plows were useless.

When Thursday night came practically all of the traffic space in and around the Works was as clear as usual. That means that about 100,000 cubic yards of snow had been removed. The work up to Thursday evening had required 8,970 man hours and 500 team hours. Say, we are not going to try to keep up with this weather man. We have to get to press.



Not the Ku Klux Klan. Just Hawthorne's Snow Shovelers Fixed Up to Defy the Elements. The "Gas Masks" were the Invention of Mrs. M. E. Kelly, Chief Matron



Inasmuch as Chicago's newest telephone exchange has an Irish name, Kildare, Rooney and McSweeney, who appear in the left-hand photograph, have made themselves very much at home. The group on the right shows Foreman Hank Marsh, the modest man in the back row, marked by the X, and his crew of installers. They were nearly all trained in the Company's wiring and circuit school at Chicago, and did a fine job at the Kildare office.

Hawthorne's Police Force in Convention Assembled



Western Electric Company

H. B. Thayer, *President*; H. A. Halligan, *Vice-President*; W. P. Sidley, *Vice-President and General Counsel*; A. L. Salt, *Vice-President and General Purchasing Agent*; Gerard Swope, *Vice-President and General Sales Manager*; H. F. Albright, *Vice-President and General Superintendent*; J. W. Johnston, *Treasurer*; F. B. Jewett, *Chief Engineer*; G. C. Pratt, *Secretary*; R. H. Gregory, *Comptroller*; C. E. Scribner, *Consulting Engineer*

Office of publication and address of President, Secretary, and Treasurer, 195 Broadway, New York City

A NEW
Western Electric
 DAVIS
 FLOOD
 LAMP

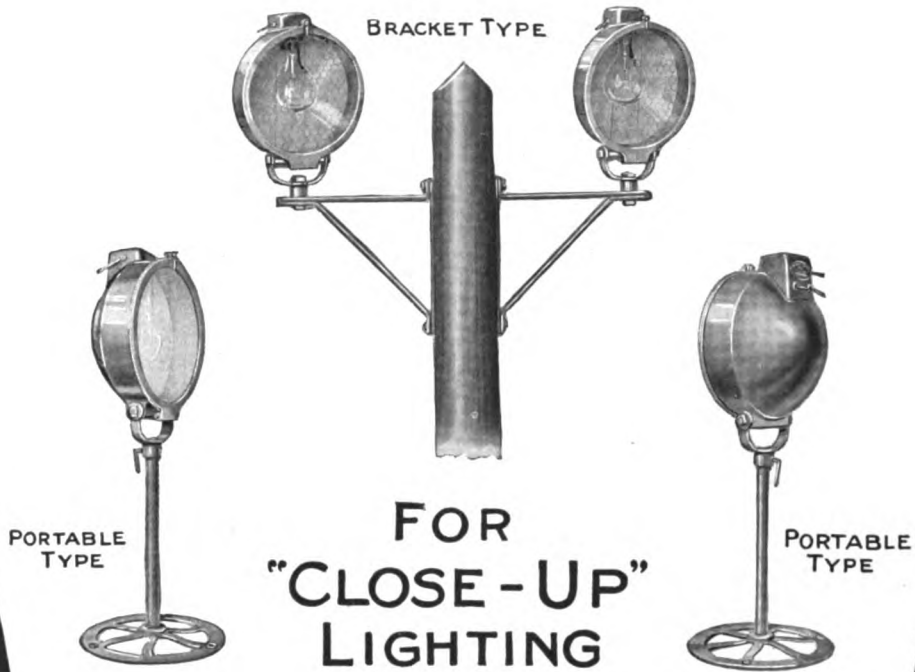

This new 500 watt unit is designed for "close up" or "short throw" work where wide diffusion is an essential. For long range lighting, the 1000 watt unit is most effective.

The maximum spread of the direct beam of the 500 watt unit is practically 40 degrees—in the indirect beam this is greater.

The unit is made of steel—bullet shaped—finished in rust-proof dark gray—absolutely water proof—easy to carry—easy to operate—easy to install.

For emergency lighting, the portable type is recommended—for permanent installation, the bracket type.

Write for price and further details.

FOR
 PROTECTION



Western Electric Company
 INCORPORATED

New York	Atlanta	Chicago	St. Louis	San Francisco
Buffalo	Savannah	Cleveland	Cincinnati	Oakland
Newark	Birmingham	Indianapolis	Kansas City	Los Angeles
Boston	New Orleans	Detroit	Omaha	Seattle
New Haven	Charlotte	Milwaukee	Oklahoma City	Portland
Philadelphia	Baltimore	Minneapolis	Dallas	Salt Lake City
Pittsburgh	Richmond	St. Paul	Houston	Denver

EQUIPMENT FOR EVERY ELECTRICAL NEED

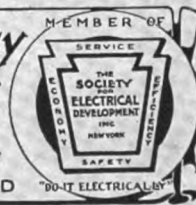

FOR
 PRODUCTION

One of the current flood-light advertisements appearing in trade papers featuring the new type of flood lamp.

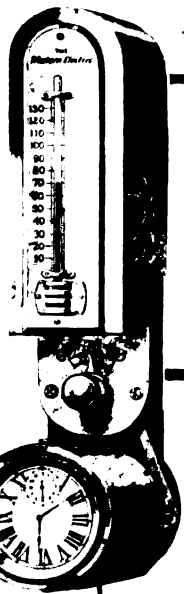

← Located on First Floor



Every Home Needs A *Western Electric* HEAT REGULATOR

It takes Complete and Accurate Charge of the Drafts and Dampers of the Home Heating Plant, and soon pays for itself in Saving of Coal and added Winter Comfort

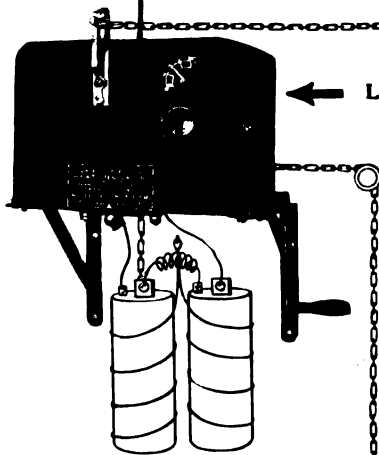

← Located in Cellar near Furnace

- Less Coal Consumed
- Longer Furnace Life
- Corrects Uneven Temperatures
- Overcomes Danger of Fire
- Permits No Heat Leakage
- Adapted to Every Furnace
- No Repair Expense
- Pays for Itself in Fuel
- Will Lift Any Damper

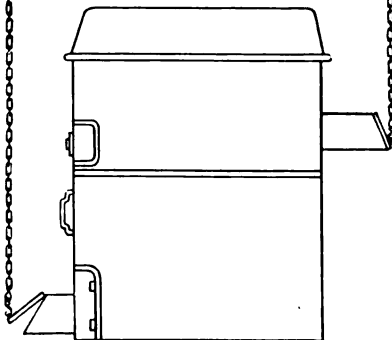

This Electrical Appliance

**Is a Quick Seller,
Is Easily Installed.**

AND

**Requires no Special Tools.
It Satisfies Every User.**

It will be

NATIONALLY ADVERTISED

in periodicals your customers read.

Write to our nearest house for Sales Helps and Agency Proposition, today. **NOW**, when the fuel problem is acute, is the time to sell Heat Regulators.

Western Electric Company
INCORPORATED

New York	Atlanta	Chicago	St. Louis	San Francisco
Hullalo	Savannah	Cleveland	Cincinnati	Oakland
Newark	Birmingham	Indianapolis	Kansas City	Los Angeles
Boston	New Orleans	Detroit	Omaha	Seattle
New Haven	Charlotte	Milwaukee	Oklahoma City	Portland
Philadelphia	Baltimore	Minneapolis	Dallas	Salt Lake City
Pittsburgh	Richmond	St. Paul	Houston	Denver

EQUIPMENT FOR EVERY ELECTRICAL NEED
Members Society for Electrical Development "Do it Electrically"



UNIVERSITY OF MINNESOTA
sci.pere v.6

Western Electric news.



3 1951 000 849 777 X

Minnesota Library Access Center



9 ZA R01 D29 S08 TIC